

DISPLAY TWO

DISPLAY THREE

Operating Instructions GA 09037_0302

GA09037_002_A1

Catalog Numbers

230024

230025

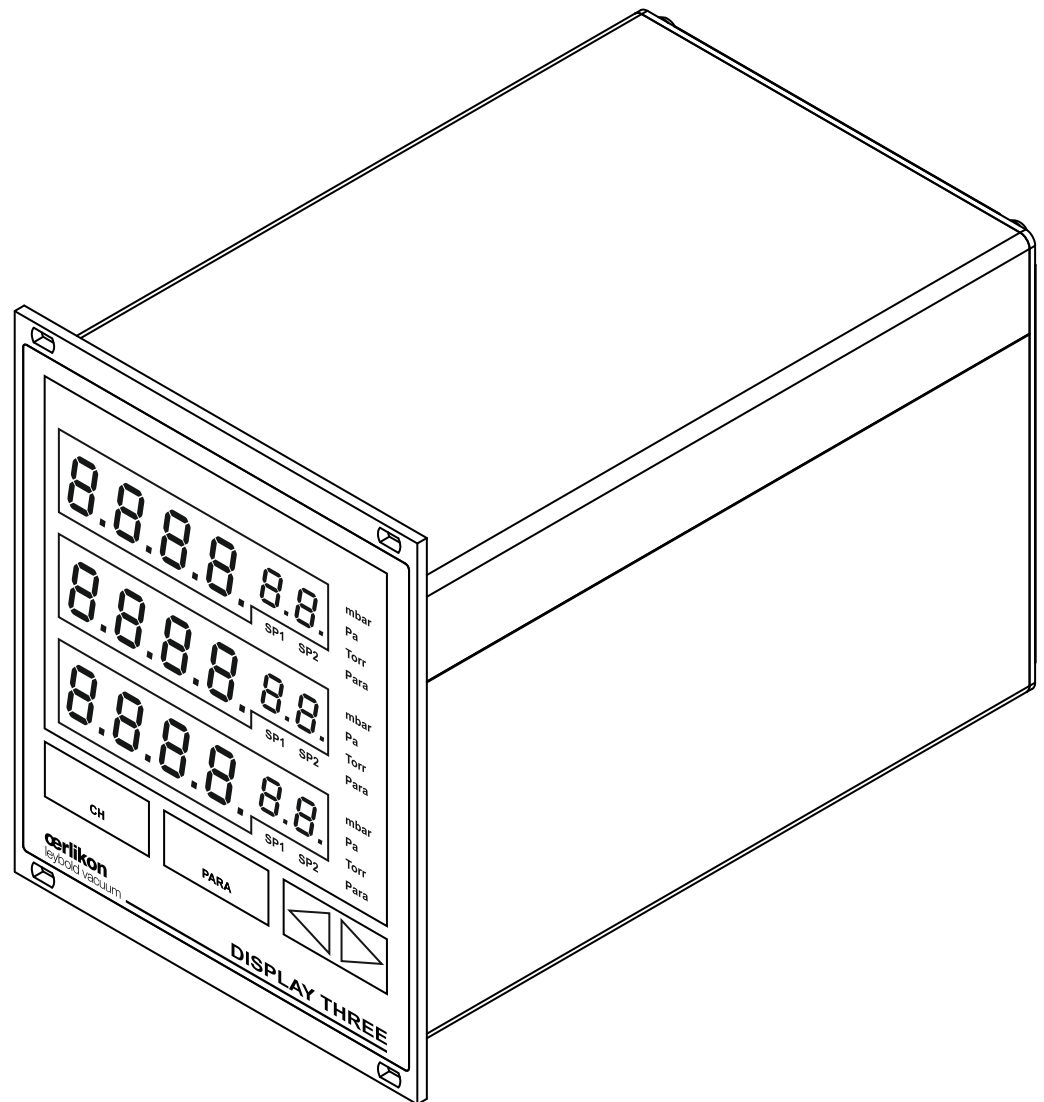

0. Table of Contents

0.	Table of Contents	1
0.1	Table of Figures	4
0.2	Table of Tables	4
1.	Description	5
1.1	Validity	5
1.1.1	Part Number	5
1.1.2	Nameplate	5
1.2	Conforming Utilisation	5
1.3	Instrument Versions	6
1.4	Responsibility and Warranty	6
1.5	Shipping Damage	6
2.	Safety	7
2.1	General Information	7
2.2	Signs and Symbols	7
2.3	Basic Safety Information	7
3.	General Equipment Description	8
3.1	Multichannel Gauge	8
3.2	Connectable Transmitters	8
4.	Technical Data	9
4.1	General Data	9
4.1.1	Mechanical Data	9
4.1.2	Standard Parameters (factory defaults)	10
4.1.3	Enviroments	10
4.1.4	Standards	10
4.2	Mains Connection	11
4.3	Measurement Channels	11
4.4	Transmitter Powering	11
4.4.1	Measurement Technique	11
4.5	Switching Functions	12
4.5.1	Switching Function Relay	12
4.5.2	Ready Signal Relay	12

4.6	Outputs and Inputs	12
4.6.1	Analog Output	12
4.6.2	Control Inputs	12
5.	Installation	13
5.1	Supplied Equipment	13
5.2	Mechanical Installation	13
5.2.1	Rack Installation	14
5.2.2	Front Panel Installation	14
5.2.3	Benchtop Instrument	15
5.3	Connections	16
5.3.1	Rear Side of the Instrument	16
5.3.2	Mains Connection	16
5.3.3	Ground Connection	17
5.3.4	Sensor	17
5.3.5	Relay	17
5.3.6	HV Control	18
5.3.7	Analog Output	18
6.	Operation	19
6.1	Front Panel	19
6.1.1	Display	19
6.1.2	Control Pushbuttons	20
6.2	Switching on and off	20
6.2.1	Switching on	20
6.2.2	Switching off	20
6.3	Operating Modes	21
6.4	Measurement Mode	21
6.4.1	Selection	21
6.4.2	Description	21
6.4.3	Pushbutton Functions	22
6.4.3.1	Measurement Channel Selection	22
6.4.3.2	Parameter Mode Selection	22
6.4.3.3	Switching on the High Vacuum Measurement Circuit	23
6.4.3.4	Switching off the High Vacuum Measurement Circuit	23
6.4.3.5	Transmitter Identification	24
6.5	Parameter Mode	25
6.5.1	Selection	25
6.5.2	Parameter Groups	25
6.5.3	Operating Concept	26
7.	Parameters	27
7.1	Switching Function Parameters (PArA SP)	27
7.1.1	Basic Terms	27
7.1.2	Configuring the Switching Functions	28
7.1.3	Adjustment Range	28

7.2	Sensor Parameters (PArA SEn)	29
7.2.1	Pirani Range Extension (PrE)	29
7.2.2	Measured Value Filter (FiLt)	29
7.2.3	Ready Function (rAEdY)	30
7.2.4	Type of Gas Correction (Cor)	30
7.2.5	Transmitter Switch-on type (S-on)	30
7.2.6	Transmitter Switch-on Value (t-on)	31
7.2.7	Transmitter Switch-off type (S-oFF)	31
7.2.8	Transmitter Switch-off Value (t-off)	32
7.3	General Parameters (PArA GEn)	32
7.3.1	Unit of Measurement (unit)	32
7.3.2	Display Format (diGit)	32
7.3.3	Display Brightness (bri)	33
7.3.4	Analog Output (AnALoG)	33
8.	Maintenance and Service	34
8.1	Maintenance	34
8.1.1	General Maintenance Information	34
8.2	Troubleshooting	34
8.2.1	Fault Indication	34
8.2.2	Error Messages	34
8.2.3	Help the Case of Faults	35
8.2.4	Fuse Replacement	35
8.2.5	Repair	35
9.	Storing and Waste Disposal	36
9.1	Packaging	36
9.2	Waste Disposal	36
Annex 1 – EC Declaration of Conformity		
Annex 2 – Safety Information on Contamination of Compressors, Vacuum Pumps and Components		

0.1 Table of Figures

Figure 1 – Nameplate (Example)	5
Figure 2 – Multichannel gauge dimensions (in mm)	9
Figure 3 – Rack installation	14
Figure 4 – Front panel cutout dimensions (in mm)	14
Figure 5 – Use as a benchtop instrument	15
Figure 6 – Rear panel of the instrument	16
Figure 7 – Connector Sensor (RJ45)	17
Figure 8 – Connector Relay (plug-in terminals, screw terminals)	17
Figure 9 – Connector HV-Control (plug-in terminals, screw terminals)	18
Figure 10 – Connector Analog Output (plug-in terminals, screw terminals)	18
Figure 11 – Front panel	19
Figure 12 – Operating the pushbutton CHANNEL	22
Figure 13 – Operating the pushbutton PARA	22
Figure 14 – Operating the pushbutton UP	23
Figure 15 – Operating the pushbutton DOWN	23
Figure 16 – Operating the pushbuttons UP and DOWN	24
Figure 17 – Behaviour of a switching function in response to pressure changes	28

0.2 Table of Tables

Table 1 – Part Numbers	5
Table 2 – Connectable Transmitters	8
Table 3 – Parameters, factory default	10
Table 4 – Supplied equipment	13
Table 5 – Display components	19
Table 6 – Display in the measurement mode	21
Table 7 – Transmitter identification	24
Table 8 – Parameter groups and corresponding parameters	25
Table 9 – Available sensor parameters	29
Table 10 – Values for the parameter PrE	29
Table 11 – Values for the parameter rEAdY	30
Table 12 – Values for the parameter unit	32
Table 13 – Values for the parameter diGit	32
Table 14 – Values for the parameter bri	33
Table 15 – Values for the parameter AnA	33
Table 16 – Error messages	34

1. Description

1.1 Validity

1.1.1 Part Number

This document applies to the following products:

Part number	Product	Version	Serial number
230024	DISPLAY TWO with EU/US mains cord	2.1f	1000 - ...
230025	DISPLAY THREE with EU/US mains cord	2.1f	1000 - ...

Table 1 – Part Numbers

1.1.2 Nameplate

A nameplate is located on the bottom side of the instrument. When communicating with Oerlikon Leybold Vacuum GmbH, stating the information on the nameplate is necessary. For this reason please enter the following information:



Figure 1 – Nameplate (Example)

1.2 Conforming Utilisation

The DISPLAY TWO and DISPLAY THREE multichannel vacuum gauge is a display and operating unit for transmitters from Oerlikon Leybold Vacuum GmbH.

It is used in combination with the transmitters from the lines THERMOVAC and PENNINGVAC and also for DU sensors and serves the purpose of measuring total pressures. The transmitters and sensors must be operated in accordance with the instructions provided in the respective Operating Instructions.

The DISPLAY TWO respectively DISPLAY THREE multichannel vacuum gauge is called in the following "multichannel gauge" for short.

Please check based on the technical data, whether the measuring instrument is suited for your application.

1.3 Instrument Versions

The multichannel gauge is available in two different versions: As DISPLAY TWO and as DISPLAY THREE. The two versions differ in the following:

- Number of measurement channels
- Number of switching functions
- Power consumption
- Weight

📖 Chapter 4 - Technical Data, page 9

Described in these Operating Instructions are both the DISPLAY TWO as well as the DISPLAY THREE.

1.4 Responsibility and Warranty

The company Oerlikon Leybold Vacuum GmbH will not assume any responsibility or honour a warranty when the operator or third persons

- do not observe the information provided in this document
- do not operate the product according to be specified conforming utilisation
- modify the product in any way (conversion, repair work etc)
- Operate the product with accessories which are not listed in the corresponding product documentation.

•

The right of introducing technical changes without prior announcement is reserved. The figures are subject to change.

1.5 Shipping Damage

- Inspect the shipping package for any external damage.
- If any damage is found, send a damage report to the forwarding agent and the insurer.
- Retain the packaging material since when filing a damages claim it is mandatory that the instrument be returned in the original packaging of the manufacturer.
- Check the delivery for completeness.
- Visually check the instrument as to any apparent damage.



DANGER: Damaged product.

Commissioning of a damaged product can present a risk to life.

2. Safety

2.1 General Information

The multichannel gauge is delivered ready for operation. Even so, we recommend that you carefully read these Operating Instructions so as to ensure optimum operating conditions right from the start.

This manual contains important information for understanding, installing, commissioning, operating and troubleshooting the multichannel gauge.

2.2 Signs and Symbols

Important instructions relating to the aspect of technical safety and industrial safety are emphasised by symbols.



DANGER or WARNING:

Information on preventing any kind of injury.



DANGER:

Information on preventing injury or damage to property caused by electricity.



NOTE:

General information on further aspects, respectively reference sections.

2.3 Basic Safety Information

During all work like installation and maintenance work, comply with the pertinent safety regulations.



DANGER: Mains voltage

Touching components at mains voltage within the instrument can, when introducing objects or admitting liquids into the instrument pose a risk to life.



DANGER: Improper utilisation

Improper utilisation can damage the instrument. Use the instrument only in accordance with the information provided by the manufacturer.



DANGER: Incorrect connection and operation data

Incorrect During all work like installation and maintenance work, comply with the pertinent safety regulations.

3. General Equipment Description

3.1 Multichannel Gauge

The DISPLAY TWO and DISPLAY THREE multichannel vacuum gauge is a display and operating unit for transmitters from Oerlikon Leybold Vacuum GmbH.

It is used in combination with the transmitters from the lines THERMOVAC and PENNINGVAC and also for DU sensors and serves the purpose of measuring total pressures. The transmitters and sensors must be operated in accordance with the instructions provided in the respective Operating Instructions.

3.2 Connectable Transmitters

The following transmitters can be operated by the multichannel gauge:

Transmitters	Type	Display
THERMOVAC	TTR90, TTR90S TTR91, TTR91S TTR96 TTR211S TTR216S	$t_{tr} (t_{tr}^E)$
THERMOVAC	TTR100, TTR100S2 TTR101, TTR101S2	$t_{tr} I (t_{tr} I^E)$
PENNINGVAC	PTR225, PTR225S, PTR237	P_{tr}
PENNINGVAC	PTR90	P_{tr90}
DU Sensor	DU200, DU201	$du200$
DU Sensor	DU2000, DU2001	$du2000$

Table 2 – Connectable Transmitters

4. Technical Data

4.1 General Data

4.1.1 Mechanical Data

Dimensions:	Width: 106.4 mm (1/4 19")
	Height: 128.4 mm (3 U)
	Depth: 162.0 mm
Weight:	DISPLAY TWO 1.3 kg
	DISPLAY THREE 1.4 kg
Installation depth:	220 mm approx. (including connected plugs)
Usage:	Rack installation Front panel installation Benchtop instrument

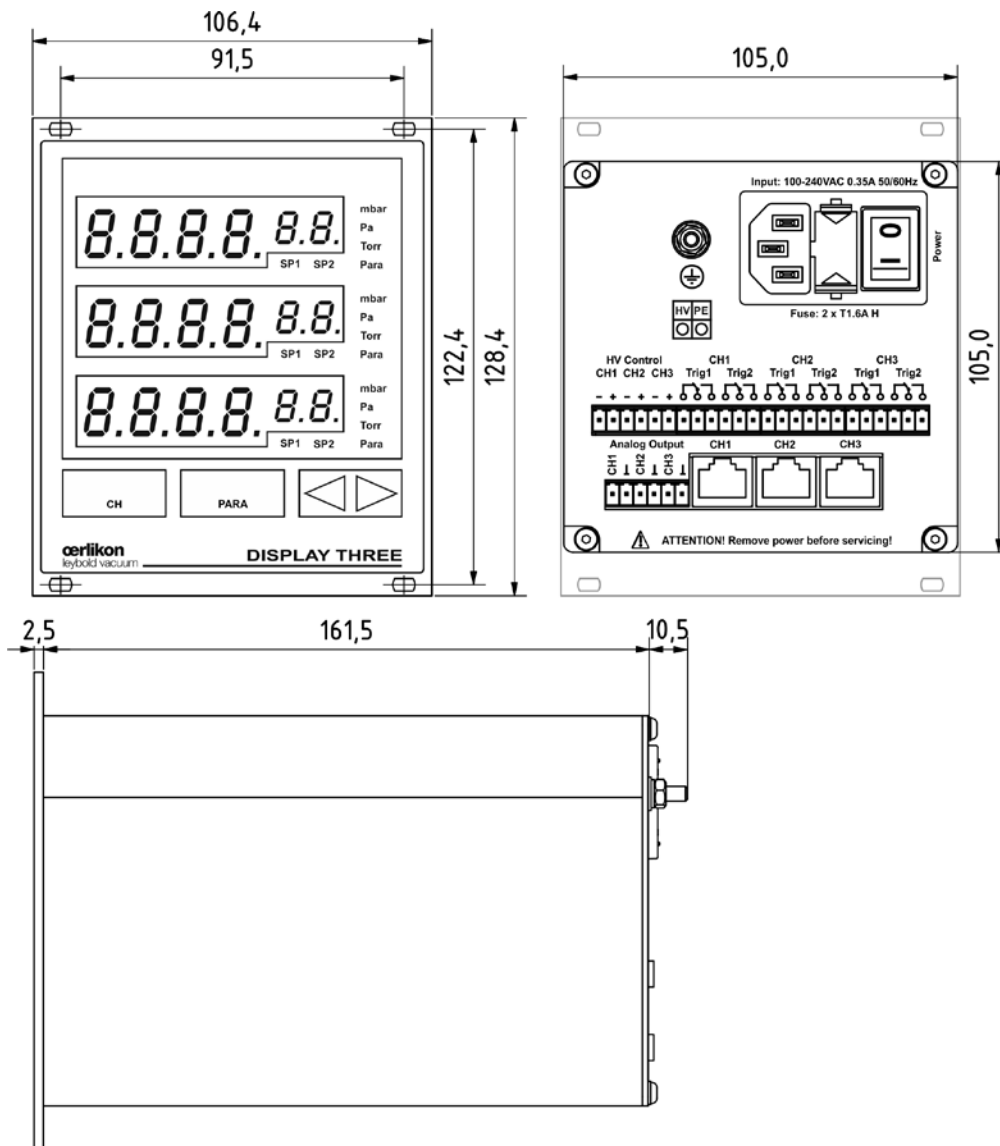

Figure 2 – Multichannel gauge dimensions (in mm)

4.1.2 Standard Parameters (factory defaults)

Parameter	Parameter description	Setting
<i>PrE</i>	Pirani range extension	<i>oFF</i>
<i>Filt</i>	Measured value filter	<i>3</i>
<i>rRDY</i>	Function Ready signal	<i>on</i>
<i>Cor</i>	Gas correction	<i>1.00</i>
<i>S-on</i>	Transmitter switch-on mode	<i>HArd</i>
<i>S-off</i>	Transmitter switch-off mode	<i>HArd</i>
<i>unit</i>	Measurement unit	<i>bAr</i>
<i>diSt</i>	Display format	<i>2</i>
<i>brt</i>	Display brightness	<i>Ht</i>
<i>AnALoG</i>	Analog output	<i>Ht</i>

Table 3 – Parameters, factory default

4.1.3 Enviroments

Temperature:	Storage: -20 ... +60 °C
	Operation: +5 ... +50 °C (sea level)
	+5 ... +30 °C (2000 m above sea level)
Relative atmospheric humidity:	80 % approx. (up to 30 °C)
	decreasing to max. 50 % (from 40 °C)
Usage:	in interior rooms (height 2000 m approx. above sea level)
Protection category:	IP40

4.1.4 Standards

- Compliance with Low Voltage Directive 2006/95/EG
- Compliance with EMC Directive 2004/108/EG

International/national standards as well as specifications:

- DIN EN 61010-1 (2002-08)
- (Safety Requirements for Electrical Equipment for Measurement, Control, and Laboratory Use)
- DIN EN 61000-6-2 (2006-03)
- (Electromagnetic Compatibility (EMC) – Part 6-2: Generic standards – Immunity for Industrial Environments)
- DIN EN 61000-6-3 (2007-09)
- (Electromagnetic Compatibility (EMC) - Part 6-3: Generic Standards - Emission Standard for Residential, Commercial and Light-Industrial Environments)

4.2 Mains Connection

Voltage:	100...240 V AC
Frequency:	50/60 Hz
Fuses:	2 x T1.6A H
Power consumption:	DISPLAY TWO < 10 W DISPLAY THREE < 15 W
Current consumption:	0.35 A approx.
Overvoltage category:	II
Protection category:	1
Connection:	Inlet connector for non-heating apparatus IEC 320 C14

4.3 Measurement Channels

Number:	DISPLAY TWO	2
	DISPLAY THREE	3
Connection sockets:	RJ45 (FCC 68)	
Connectable transmitters:	THERMOVAC	TTR90, TTR90S, TTR91, TTR91S, TTR96S TTR211S, TTR216S
	THERMOVAC	TTR100, TTR100S2 TTR101, TTR101S2
	PENNINGVAC	PTR225, PTR225S, PTR237
	PENNINGVAC	PTR90
	DU Sensor	DU200, DU201 DU2000, DU2001

4.4 Transmitter Powering

Voltage:	+24 VDC $\pm 5\%$
Current:	max. 100 mA
Fusing:	200 mA, self resetting

Powering complies with the requirements of a protective low voltage (SELV-E in accordance with EN 61010).

4.4.1 Measurement Technique

Measurement ranges:	Transmitter dependent
Measurement error:	Gain error $\leq 0.1\%$ FS Offset error $\leq 0.02\%$ FS
Measurement rate:	1000 s ⁻¹
Display rate:	4 s ⁻¹
Filter time constant:	Slow ...fast 15...7...3...1
Units of measurement:	mbar, Pa, Torr
Correction options:	Correction factor
A/D converter resolution:	> 15 Bit

4.5 Switching Functions

Number of switching functions:	DISPLAY TWO	4
	DISPLAY THREE	6
Assignment:	2 per channel	
Response time:	< 50 ms	
Adjustment range:	Transmitter dependent	
Hysteresis:	adjustable ≥ 10 % of measurement value	

4.5.1 Switching Function Relay

Number:	1 per channel
Type of contact:	Changeover contact, floating
Load (resistive):	Switched current: 1 A approx. Switched voltage: 30 V AC / 30 V DC approx.
Service life:	Mechanical: $5 \cdot 10^6$ actuations Electrical: 10^5 actuations at maximum load
Connection:	Plug-in terminals, screw terminals

4.5.2 Ready Signal Relay

Number:	1 per channel, as the 2. switching function configurable
Type of contact:	Changeover contact, floating
Load (resistive):	Switched current: 1 A approx. Switched voltage: 30 V AC / 30 V DC approx.
Service life:	Mechanical: $5 \cdot 10^6$ actuations Electrical: 10^5 actuations at maximum load
Connection:	Plug-in terminals, screw terminals

4.6 Outputs and Inputs

4.6.1 Analog Output

Number:	1 per channel
Voltage range:	0...10 VDC / 0...5 VDC selectable
Deviation from the displ. value:	± 0.1 % FS
Internal resistance:	100 Ω
Relationship between voltage and pressure:	Transmitter dependent
Connections:	Plug-in terminals, screw terminals

4.6.2 Control Inputs

Number:	1 per channel
Voltage range:	0...24 VDC
Connections:	Plug-in terminals, screw terminals

5. Installation

5.1 Supplied Equipment

Designation	Quantity
Multichannel Gauge	1
Mains cord with shockproof plug (EU)	1
Mains cord with shockproof plug (US)	1
Operating Instructions (each GER and ENG)	1
Spare fuses	2
Neck collar screws	4
Plastic sleeves	4
Edge protection	1
Adhesive feet	2
Mating connectors	DISPLAY TWO 4 DISPLAY THREE 5

Table 4 – Supplied equipment

5.2 Mechanical Installation

The multichannel gauge can be used as follows:

- Rack installation
- Front panel installation
- Benchtop instrument



WARNING: Mains power shutdown

Install the instrument so or place it so that you are in a position to operate the mains switch at any time or ensure that the mains power can be shut down at any time.

5.2.1 Rack Installation

The multichannel gauge has been designed for installation within a sub-rack (19", 3 U) in accordance with DIN EN 60297 (IEC 60297) (🔗📖 Figure 3, page 14). For this purpose the supplied equipment includes four neck collar screws and four plastic sleeves.

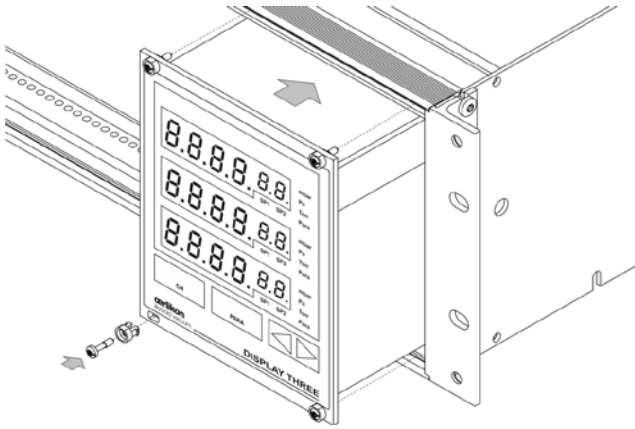

Figure 3 – Rack installation

- Attach the sub-rack within the rack.
- Push the multichannel gauge into the sub-rack.
- Affix the instrument to the sub-rack with the neck collar screws and the plastic sleeves included in the delivery.

5.2.2 Front Panel Installation

For panel mounting of the instrument, the following cutout (🔗📖 Figure 4, page 14) is required:

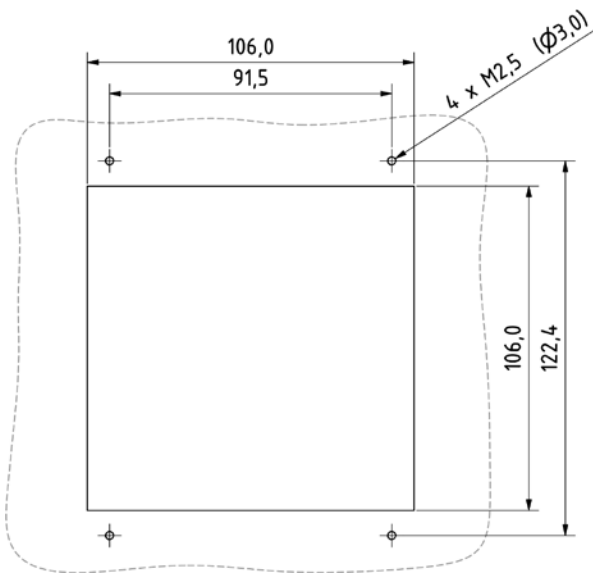

Figure 4 – Front panel cutout dimensions (in mm)

- Guide the multichannel gauge into the cutout.
- Affix the instrument with four M3 screws.

5.2.3 Benchtop Instrument

When intending to use the multichannel gauge as a benchtop instrument, then proceed as follows:

- Place the multichannel gauge on its back (🔑📖 Figure 5, page 15)
- Push the edge protector included in the delivery onto the bottom edge of the front panel
- Stick the rubber feet included in the delivery to the bottom of the enclosure

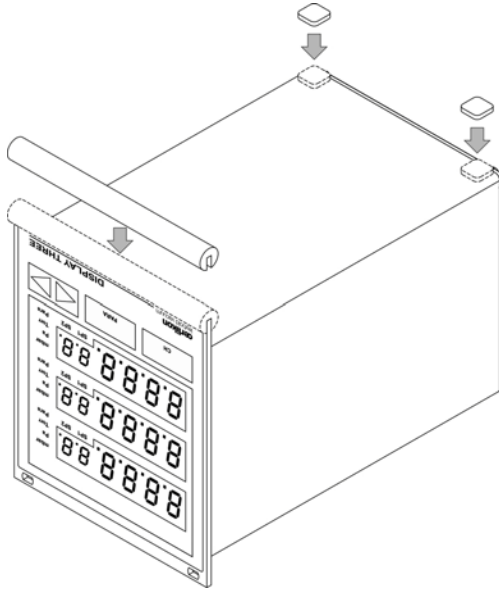

Figure 5 – Use as a benchtop instrument

- Turn the multichannel gauge back over and move it to the desired place.

5.3 Connections

5.3.1 Rear Side of the Instrument

The Figure 6, page 16 depicts the rear panel of the multichannel gauge. The way in which the individual connections have been wired is described in the following sections.

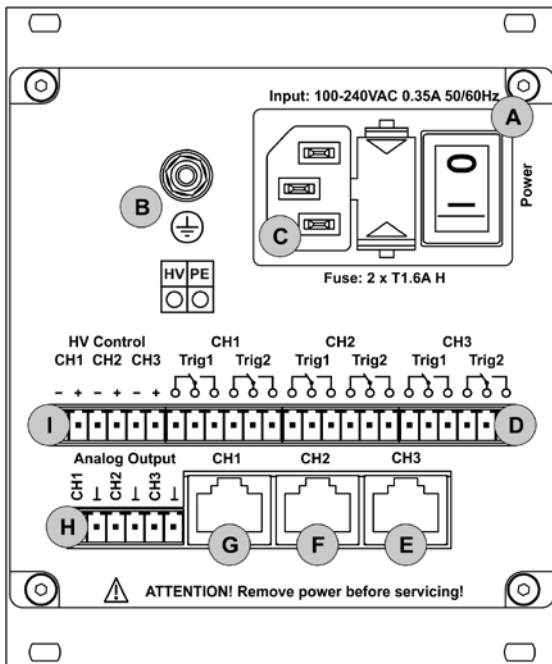



Figure 6 – Rear panel of the instrument

A	Mains switch
B	Ground screw
C	Mains connection
D	Connection Relay
E	Connection for transmitter, measurement channel 3
F	Connection for transmitter, measurement channel 2
G	Connection for transmitter, measurement channel 1
H	Connection Analog Output
I	Connection HV Control

5.3.2 Mains Connection

The mains connection on the rear panel ( Figure 6, C, page 16) is intended only for a mains cord which on the instrument side is provided with an inlet connector for non-heating apparatus.

A mains cord is included with the instrument. If the mains plug is not compatible with your mains outlets, you need to procure a suitable mains cord:

- Three core cable with protective ground connection
- Wire cross-section $3 \times 0.75 \text{ mm}^2$ or more



WARNING: Mains voltage

Instruments which have not been professionally connected to ground can in the case of a malfunction present a risk to life. For this reason use only 3 wire mains, respectively extension cords with connected protective ground conductor. Insert the mains plug only into a mains outlet with a properly connected protective ground conductor.

- Insert the plug of the mains cord into the mains socket provided on the instrument.
- Insert the mains plug of the mains cord into the mains outlet.



NOTE:

When installing the instrument in an electrical cabinet, the mains voltage may be supplied through a switched mains power distributor.

5.3.3 Ground Connection

With the aid of the ground screw (☞📖 Figure 6, B, page 16) the multichannel gauge can be connected to the protective ground of the vacuum chamber.

If required: Connect the protective ground of the vacuum chamber to the ground screw using a protective ground conductor cable.

5.3.4 Sensor

The connection marked Sensor serves the purpose of connecting transmitters. For each measurement channel and 8-way RJ45 socket is available. (☞📖 Figure 6, E, F, G, page 16 and Figure 7, page 17).

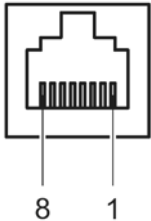

Figure 7 – Connector Sensor (RJ45)

1	+24 V DC	5	Signal ground
2	Power ground	6	Status (for PTR)
3	Signal	7	HV on (for PTR)
4	Ident resistant	8	not available



CAUTION: Unpermissible Transmitter

Transmitters which are not intended to be operated in connection with the multichannel gauge can damage the instrument. Always operate the multichannel gauge with the permitted transmitters. ☞📖 Chapter 3.2 Connectable Transmitter, page 8 .

Connecting:

- Measurement channel 1, 2 and/or 3: Connect of the transmitter using a shielded straight through cable to the connection CH1, CH2 and/or CH3.

5.3.5 Relay

The switching functions and the ready monitor influence the switching action of various relays within the multichannel gauge. Through the connection marked Relay (☞📖 Figure 6, D, page 16 and Figure 8, page 17) you may utilise the relay contacts for switching purposes. The relay contacts are floating.

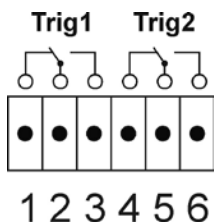

Figure 8 – Connector Relay (plug-in terminals, screw terminals)

1	SP 1 Normally closed contact (NC)
2	SP 1 Common contact (COM)
3	SP 1 Normaly open contact (NO)
4	SP 2 Normally closed contact (NC)
5	SP 2 Common contact (COM)
6	SP 2 Normaly open contact (NO) or Ready contact



WARNING: Shock hazard voltages

Voltages over 60 V DC or 30 V AC are considered as shock hazard voltages. Through the connection marked RELAY only voltages of 60 V DC or 30 V AC approx. may be switched. These voltages must correspond to the requirements of a protective low voltage (SEL-E in accordance with EN 61010).

5.3.6 HV Control

The connection HV Control (📖 Figure 6, I, page 16 and Figure 9, page 18) provides the following connections:

- HV ON. Here the high vacuum circuit of the PENNINGVAC Transmitter (PTR225 and PTR237 only) can be switched on and off.
The following applies to the signal level: On = +12...24 VDC. Off = 0 VDC.

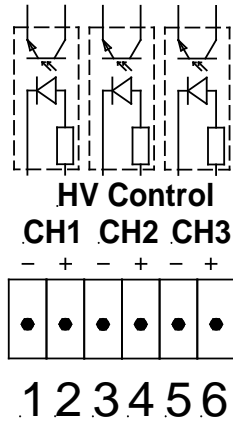

Figure 9 – Connector HV-Control (plug-in terminals, screw terminals)

- | | |
|---|------------------------------------|
| 1 | Measurement channel 1 - |
| 2 | Measurement channel 1 +12...24 VDC |
| 3 | Measurement channel 2 - |
| 4 | Measurement channel 2 +12...24 VDC |
| 5 | Measurement channel 3 - |
| 6 | Measurement channel 3 +12...24 VDC |

- We recommend the use of shielded connection cables.

5.3.7 Analog Output

The connection marked Analog Output (📖 Figure 6, H, page 16 and Figure 10 , page 18) provides the following connections:

- Analog outputs for the signals of the individual measurement channels.

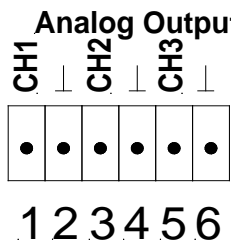

Figure 10 – Connector Analog Output (plug-in terminals, screw terminals)

- | | |
|---|--|
| 1 | Analog output of measurement channel 1 |
| 2 | Ground of measurement channel 1 |
| 3 | Analog output of measurement channel 2 |
| 4 | Ground of measurement channel 2 |
| 5 | Analog output of measurement channel 3 |
| 6 | Ground of measurement channel 3 |

- We recommend the use of shielded connection cables.

6. Operation

6.1 Front Panel

Shown in Figure 11, page 19 is the front panel of the DISPLAY THREE. In the case of the DISPLAY TWO the display for measurement channel 3 (Item C) are not present.

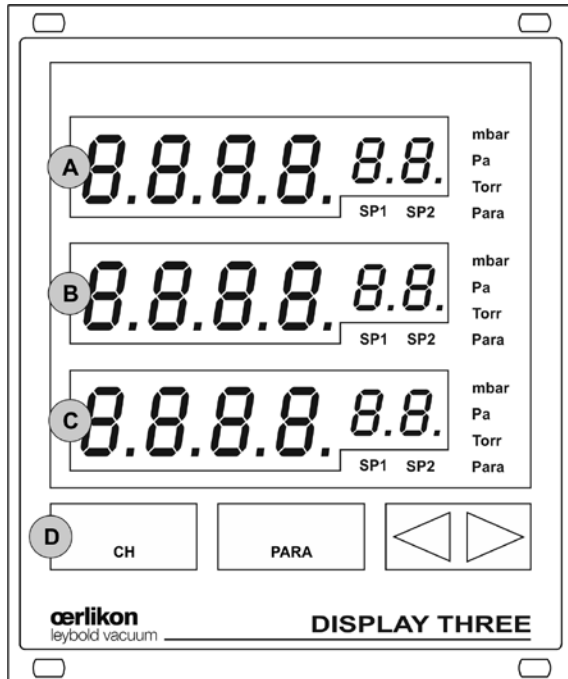

Figure 11 – Front panel

- A Display of channel 1 with two corresponding switching thresholds
- B Display of channel 2 with two corresponding switching thresholds
- C Display of channel 3 with two corresponding switching thresholds
- D Status indication operating pushbuttons

6.1.1 Display

A separate display area is provided for each measurement channel (Item A, B, C). In the display area, the following information is shown from left to right:

Display	Description
8.8.8.8.^{B.B.}	Measured value or status message
SP1, SP2	Switching function status When the symbol is lit, the pressure is then below the lower threshold When the symbol is not lit, then the pressure is above the upper threshold
mbar, Pa, Torr	Pressure unit (applies to all channels)
Para	Channel selection, configuration mode for channel

Table 5 – Display components

6.1.2 Control Pushbuttons

CH

Through the key marked CH you can select a measurement channel. This is necessary, for example, when wanting to switch a certain transmitter on or off, or when wanting to change the sensor parameters. The symbol Para for the selected measurement channel flashes for 10 seconds.

PARA

Through the pushbutton PARA you can invoke the parameter mode for switching threshold, sensor and general parameters. The indicator Para for the selected measurement channel comes on. You can set up different parameters.

Arrow pushbuttons (<I DOWN / I> UP)

The arrow pushbuttons are needed so as to be able to enter data in the parameter mode or switch the PENNINGVAC Transmitter (PTR225 and PTR237 only) on or off (👉📖 Chapter 6.4.3.3 Switching on the High Vacuum Measurement Circuit, page 23 and chapter 6.4.3.4 Switching off the High Vacuum Measurement Circuit, page 23). By operating the pushbuttons, a default value can be reduced or increased. The corresponding pushbuttons are designated in the following as DOWN (<I) and UP (I>).

6.2 Switching on and off

6.2.1 Switching on

- Switch the instrument on through its mains switch.
- After switching on, the multichannel gauge runs the following:
 - Self test
 - Display test
 - Display of the software version used
 - Re-establishing the parameters set up last
 - Identification of the connected measuring equipment
 - Activation of the measurement mode

6.2.2 Switching off

- Switch the instrument off through its mains switch.







WARNING: Waiting time

Wait for at least 5 seconds before switching the instrument on again.

6.3 Operating Modes

The multichannel gauge may be operated in one of the following operating modes:

- **Measurement Mode**
The measurement mode is the standard operating mode. Here the measured values or status messages are displayed.
-   Chapter 6.4 Measurement Mode, page 21
- **Parameter Mode**
In the parameter mode you have access to different parameters. You can simply view the parameters all change them with the aid of the arrow keys. In this way you can configure the multichannel gauge.
-   Chapter 6.5 Parameter Mode, page 25

6.4 Measurement Mode

6.4.1 Selection

After switching on the multichannel gauge it will automatically run the measurement mode. If running the parameter mode and when not operating a key for 10 seconds the instrument will then automatically revert back to the measurement mode.

6.4.2 Description

In the measurement mode the measured values of the transmitters are displayed. When the pressure is outside the permissible range, then a status message is displayed. Measurement channels to which no gauge head has been connected will indicate noSEn. This status message is erased after 30 seconds and 4 dots are displayed.

Display	Description
BBBBⁿⁿ or cB.BB^B	Above the permissible range (DU Sensors excluded)
oooo	Above the measurement range (DU Sensors only)
B.BBB^B	Within the permissible range
cB.BB^B	Below the permissible range (DU Sensors excluded)
oFF	PENNINGVAC Transmitter (PTR225 and PTR237 only) has been switched off
HU on	PENNINGVAC Transmitter (PTR225 and PTR237 only) is on (Switching-on procedure, still no valid measured value available)
c0	Lowly below the measurement range (DU Sensors only)
cc0	Middle below the measurement range (DU Sensors only)
ccc0	Large below the measurement range (DU Sensors only)

Table 6 – Display in the measurement mode

6.4.3 Pushbutton Functions

6.4.3.1 Measurement Channel Selection

- Press the pushbutton CH.
 - The instrument selects the next measurement channel. The display of Para for the selected measurement channel will flash for 10 seconds.

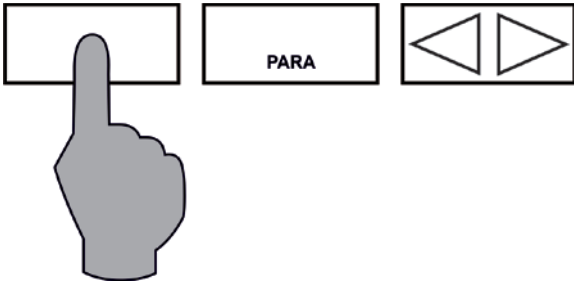

Figure 12 – Operating the pushbutton CHANNEL

6.4.3.2 Parameter Mode Selection

- Press the pushbutton PARA and keep it depressed for approximately 2 seconds. The instrument will change to the parameter mode (☞ Chapter 6.5 Parameter Mode, page 25).
 - When not operating any pushbutton within 10 seconds, the instrument will then automatically return to the measurement mode.

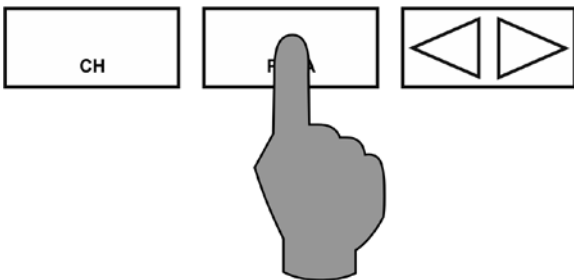

Figure 13 – Operating the pushbutton PARA

6.4.3.3 Switching on the High Vacuum Measurement Circuit

The high vacuum measurement circuit of the following transmitters can be switched on manually: PENNINGVAC Transmitter (PTR225 and PTR237 only).

For this the transmitter control must be set to HAnd (👉📖 Chapter 7.2.5 Transmitter Switch-on Type (S-on), page 30).

- Keep the key marked CH pressed so as to select the respective measurement channel.
- Keep the key marked UP pressed for approximately two seconds.
 - The transmitter for the selected measurement channel is switched on. Either the measured value or a status message will be displayed. 👉📖 Table 6, page 21.

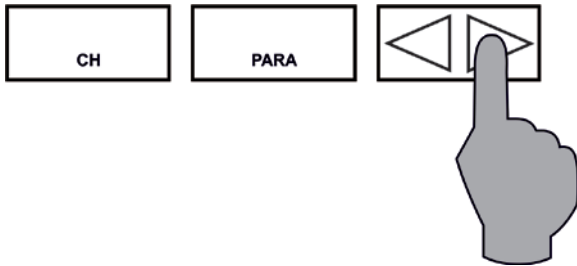

Figure 14 – Operating the pushbutton UP

6.4.3.4 Switching off the High Vacuum Measurement Circuit

The high vacuum measurement circuit of the following transmitters can be switched off manually: PENNINGVAC Transmitter (PTR225 and PTR237 only).

For this in the transmitter control must be set to HAnd (👉📖 Chapter 7.2.7 Transmitter Switch-off Type (S-OFF), page 31).

- Keep the key marked CH pressed so as to select the respective measurement channel.
- Keep the key marked DOWN pressed for approximately two seconds.
 - The transmitter for the selected measurement channel is switched off. The display will indicate the status OFF.

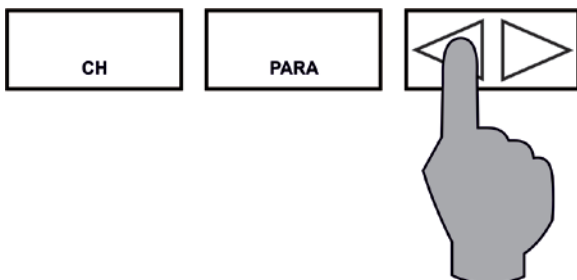



Figure 15 – Operating the pushbutton DOWN

6.4.3.5 Transmitter Identification

- Keep the keys UP and DOWN pressed for approximately one second.
 - On the displays for the individual measurement channels the in each case connected transmitters are indicated.  Table 7, page 24.

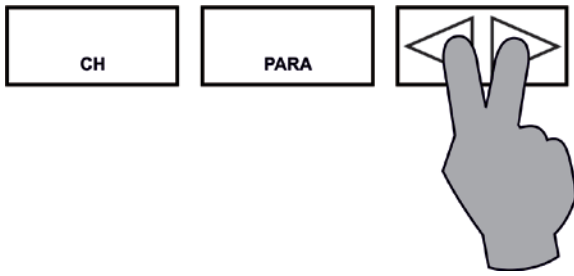

Figure 16 – Operating the pushbuttons UP and DOWN

Display	Transmitter type
$t_{tr} (t_{tr}^E)$	THERMOVAC (TTR90, TTR90S, TTR91, TTR91S, TTR96, TTR211, TTR216)
$t_{tr} I (t_{tr} I^E)$	THERMOVAC (TTR100, TTR100S2, TTR101, TTR101S2)
P_{tr}	PENNINGVAC (PTR225, PTR237)
P_{tr90}	PENNINGVAC (PTR90)
$du200$	DU Sensor (DU200, DU201)
$du2000$	DU Sensor (DU2000, DU2001)
$no SE_n$	No transmitter connected (no sensor). The indication will disappear after 30 seconds.
. . . .	No transmitter connected (no sensor).

Table 7 – Transmitter identification

6.5 Parameter Mode

6.5.1 Selection

By operating the PARA pushbutton for approximately 2 seconds the instrument changes from the measurement mode to the parameter mode. The Para indicator comes on for the channel selected in each case. When the instrument is running in the parameter mode and if no pushbutton is operated for 10 seconds, then the instrument will automatically return back to the measurement mode. The Para indicator for the channel which was selected in each case is turned off.

6.5.2 Parameter Groups

In the parameter mode you have access to different parameters. You may view these parameters or change these with the aid of the arrow pushbuttons. In this way you can configure the instrument. Table 8, page 25 depicts all available parameters.

Parameter group	Parameter
<i>PARA</i> <i>SP</i>	<i>SP I-L</i> <i>SP I-H</i> <i>SP2-L</i> (only with deselected ready function) <i>SP2-H</i> (only with deselected ready function)
<i>PARA</i> <i>SEn</i>	<i>PrE</i> <i>F iLt</i> <i>rERAdY</i> <i>Cor</i> <i>S-on</i> <i>S-off</i>
<i>PARA</i> <i>GE_n</i>	<i>un it</i> <i>d iG it</i> <i>br i</i> <i>ANALoG</i>

Table 8 – Parameter groups and corresponding parameters

The available parameters have been divided into the following parameter sets:

Switching function parameters (PARA SP)

These parameters affect only the sensor of the selected measurement channel. Per measurement channel, two switching functions are available.

☞  Chapter 7.1 Switching Function Parameters (PARA SP), page 27.

Sensor parameters (PARA SE_n)

These parameters affect only the selected measurement channel. For each measurement channel a separate set of parameters is available which will depend on the type of connected transmitter.

☞  Chapter 7.2 Sensor Parameters (PARA SE_n), page 28.

General parameters (PARA GE_n)

With the aid of these parameters you can generally configure the instrument. The parameter is applied to all measurement channels.

☞  Chapter 7.3 General Parameters (PARA GE_n), Page 32.

6.5.3 Operating Concept

From the measurement mode, you can select and change a certain parameter as follows:

- Press the pushbutton CH, so as to select the desired measurement channel (only necessary when wanting to change a sensor parameter)
 - The Para status indicator flashes for the selected channel.
- Press the PARA pushbutton for about 2 seconds.
 - You have now invoked the parameter menu.
- Use the arrow pushbuttons to select the desired parameter group.
 - The name of the parameter group is displayed.
- Press the PARA pushbutton to select the desired parameter.
 - The name and the value of the parameter are displayed.
- Use the arrow pushbuttons and to change the value of the parameter.
 - The value of the parameter is changed.
- Repeat the last 2 steps so as to change further parameters of the same parameter group.

After having accessed the last parameter of a parameter group, the instrument will switch back to the measurement mode. Changes to the parameters become effective immediately and are automatically saved to the EEPROM.

When the instrument is running in the parameter mode and if for a period of 10 seconds no changes are made to the parameters, then the instrument will automatically return to the measurement mode. Any parameter changes made up to this point are automatically saved to the EEPROM.

7. Parameters

7.1 Switching Function Parameters (PArA SP)

In this parameter group you can configure the switching functions. The multichannel gauge provides the following switching function parameters:

- SP1-Lo
- SP1-Hi



- SP2-Lo (only with deselected ready function)
- SP2-Hi (only with deselected ready function)

7.1.1 Basic Terms

Switching functions

The DISPLAY TWO contains four relays with change-over contacts, from which two for switching functions and two are available as ready function. The relays for the ready functions can be used alternatively also for switching functions.

The DISPLAY THREE contains six relays with change-over contacts, from which three for switching functions and three are available as ready function. The relays for the ready functions can be used alternatively also for switching functions.

The contacts of the relays are floating and may be used for switching purposes through the connection marked Relay Output (  5.3.5 Relay, page 17).

Threshold values

The switching behaviour of individual relays is defined in each case through two parameters: the lower threshold and the upper threshold value of the switching function.



Lower threshold value SPx-Lo

The lower threshold value governs switching on of the assigned switching function. When the pressure drops below the lower threshold value, then the relay is energised. The common contact of the relay is then connected to the normally open contact.

Upper threshold value SPx-Hi

The upper threshold value governs switching off of the assigned switching function. When the pressure exceeds the upper switching threshold, then the relay is de-energised. The common contact of the relay is then connected to the normally closed contact.

Hysteresis

In the pressure range between the two thresholds, the current relay status is maintained. Within this range the relay will not switch over and the relay status depends on the history (  Figure 17, page 28).

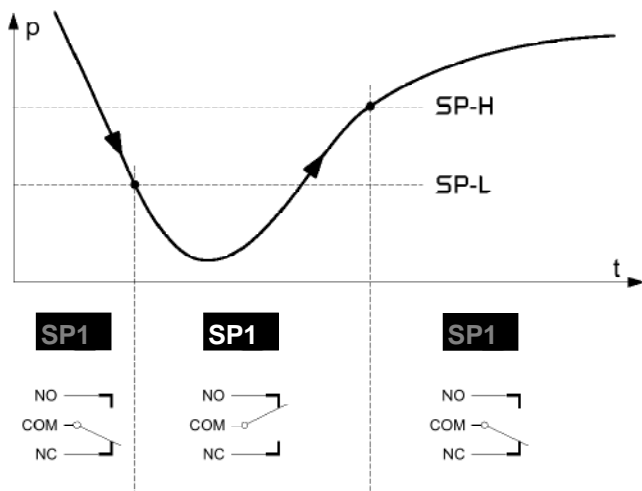

Figure 17 – Behaviour of a switching function in response to pressure changes

p Pressure
t Time
NO Normally open contact
COM Common contact
NC Normally closed contact

The range between the lower and the upper threshold value produces a certain amount of hysteresis between switching on and switching off of the relay. The hysteresis prevents rapid switching on and off of the switching function when the pressure is close to a switching threshold.

7.1.2 Configuring the Switching Functions

- Select the desired measurement channel by operating the pushbutton CH several times.
- Keep the pushbutton PARA depressed for approximately 2 seconds.
 - The instrument is now running the parameter mode in the parameter group SP.
- Press the pushbutton PARA to select the desired parameter.
 - The name and the value of the parameter are displayed.
- Use the arrow pushbuttons so as to change the threshold value.
 - The value of the parameter is changed.
- Repeat the steps to change further parameters of the parameter group.

7.1.3 Adjustment Range

The upper and the lower threshold value can be changed depending on the type of sensor in the range between $1 \cdot 10^3$ and $1 \cdot 10^{-12}$ mbar. Hysteresis amounts to at least 10% of the lower threshold value.



CAUTION:
Select the threshold values only within the range of the selected sensor.



CAUTION:
The threshold values have to be adjusted when the sensor type on a measuring channel has been changed.

7.2 Sensor Parameters (PArA SEn)

For each measurement channel there exists a separate set of sensor parameters. Depending on which transmitter is connected to the respective measurement channel, different parameters are available (🔑📖 Table 9, page 29).

Transmitters	PrE	FiLt	rAEdY	Cor	S-on	S-oFF
t_{tr} (t_{tr}^E)	✓	✓	✓			
$t_{tr} I$ ($t_{tr} I^E$)	✓	✓	✓			
P_{tr}		✓	✓	✓	✓	✓
P_{tr90}		✓	✓			
$dU200$		✓	✓			
$dU2000$		✓	✓			

Table 9 – Available sensor parameters

- Select the desired measurement channel by operating the pushbutton CH several times.
- Keep the pushbutton PARA depressed for approximately 2 seconds
 - The instrument is now running the parameter mode.
- Use the arrow keys to access the parameter group SEn.
- Press the pushbutton PARA to select the desired parameter.
 - The name and the value of the parameter are displayed.
- Use the arrow keys to change the parameter setting.
- Repeat the steps to change further parameters of the parameter group.

7.2.1 Pirani Range Extension (PrE)

Pirani range extension for THERMOVAC transmitters.

Display	Description
oFF	Pirani range extension deactivated Transmitter indicated as t_{tr} or $t_{tr} I$
oN	Pirani range extension activated Transmitter indicated as t_{tr}^E or $t_{tr} I^E$

Table 10 – Values for the parameter PrE

7.2.2 Measured Value Filter (FiLt)

The measurement value filter improves processing of unstable signals or signals suffering from interference. The filter has an effect on the display and on the switching functions. However, the analog outputs are not influenced.

For the measured value filter you may select between the values **1**, **3**, **7** and **15**. Here **1** stands for **fast** and **15** for **slow**. The values **3** and **7** are **corresponding intermediate**

values. In case of a two digit display the use of filter factor of 3 is recommended, in the case of a three digit display filter factor 15 is recommended.

7.2.3 Ready Function (rAE_dY)

The second relay per channel makes according to standard a ready signal available. Alternatively this relay can be used in addition, as the second switching function.

Display	Description
o _n	Ready signal function activated
o _{FF}	Switching function activated

Table 11 – Values for the parameter rEAdY

7.2.4 Type of Gas Correction (Cor)

Transmitters have normally been calibrated for measurements in nitrogen or air. With the aid of the parameter Cor you can adjust the measurement channel to other type of gases (PENNINGVAC Transmitter PTR225 and PTR237 only).

For this proceed as follows

- Select the parameter Cor.
- Press the key marked PARA.
 - The correction factor is displayed.
- Use the arrow keys to change the correction factor.
 - The value of the parameter is changed.

You can adjust the correction factor for a transmitter within the range of 0.1... 1.0 ... 9.9. The setting of 1.0 supplies the uncorrected measured values (for nitrogen or air).

7.2.5 Transmitter Switch-on type (S-on)

This parameter defines how the PENNINGVAC Transmitter (PTR225 and PTR237 only) is switched on. You can set up the switch-on type to the following:

HAnd

Manual. The transmitter can be switched on by pressing the key marked UP.

(  Chapter 6.4.3.3 Switching on the High Vacuum Measurement Circuit, page 23)

ECt

Externally through optocoupler (static signal +12... 24 V DC)

Hot

Warm start. The transmitter is switched on automatically upon switching on the instrument. After a power failure the measurement is started automatically.

CH 1

Through measurement channel 1. With the aid of the next parameter t-on you can define a switch-on threshold. As soon as the pressure in measurement channel 1 drops below the switch-on threshold, the transmitter will be switched on.

CH 2

Through measurement channel 2. With the aid of the next parameter t-on you can define a switch-on threshold. As soon as the pressure in measurement channel 2 drops below the switch-on threshold, the transmitter will be switched on.

CH 3

Through measurement channel 3. This setting is only available in the case of the DISPLAY THREE. With the aid of the next parameter t-on you can define a switch-on threshold. As soon as the pressure in measurement channel 3 drops below the switch-on threshold, the transmitter will be switched on.

7.2.6 Transmitter Switch-on Value (t-on)

This parameter will only appear when the sensor switch-on time has been set to CH 1, CH 2 or CH 3 (📖 Chapter 7.2.5 Transmitter Switch-on type (S-on), page 30).

Through the parameter t-on you can define a switch-on value. When the pressure in the respective measurement channel drops below the switch-on value, the PENNINGVAC Transmitter (PTR225 and PTR237 only) is switched on.

7.2.7 Transmitter Switch-off type (S-oFF)

This parameter defines how the PENNINGVAC Transmitter (PTR225 and PTR237 only) is switched off. You can set the switch-off type to the following:

HAnd

Manual. The transmitter can be switched off by pressing the key marked DOWN. (📖 Chapter 6.4.3.4 Switching off the High Vacuum Measurement Circuit, page 23)

ECt

Externally through optocoupler (static signal +12... 24 V DC)

SELF

Self monitoring. With the aid of the next parameter t-off you can define a switch-off threshold. When the pressure at the transmitter exceeds the switch off threshold, the transmitter will be switched off.

CH 1

Through measurement channel 1. With the aid of the next parameter t-off you can define a switch-off threshold. As soon as the pressure in measurement channel 1 exceeds the switch-off threshold, the transmitter will be switched off.

CH 2

Through measurement channel 2. With the aid of the next parameter t-off you can define a switch-off threshold. As soon as the pressure in measurement channel 2 exceeds the switch-off threshold, the transmitter will be switched off.

CH 3

Through measurement channel 3. This setting is only available in the case of the DISPLAY THREE. With the aid of the next parameter t-off you can define a switch-off threshold. As soon as the pressure in measurement channel 3 exceeds the switch-off threshold, the transmitter will be switched off.

7.2.8 Transmitter Switch-off Value (t-off)

This parameter will only appear when the transmitter switch-off type has been set to CH 1, CH 2 or CH 3 (🔑📖 Chapter 7.2.7 Transmitter Switch-off type (S-oFF), page 31).

Through the parameter t-off you can define a switch-off value. When the pressure in the respective measurement channel exceeds the switch-off value, the PENNINGVAC Transmitter (PTR225 and PTR237 only) is switched off.

7.3 General Parameters (PArA GEn)

With the aid of these parameters you can generally configure the instrument. The parameters apply to all measurement channels.

- Keep the pushbutton PARA depressed for approximately 2 seconds.
 - The instrument is now in the parameter mode.
- Use the arrow pushbuttons so as to access the parameter group GEn.
- Press the pushbutton PARA to select the desired parameter.
 - The name and the value of the parameter are displayed.
- Use the arrow pushbuttons so as to change the parameter setting.
- Repeat the steps so as to change further parameters of the parameter group.

7.3.1 Unit of Measurement (unit)

Unit of measurement for pressure values. This unit of measurement affects the displayed pressure values, threshold values etc.

Display	Description
bAr	Unit of measurement mbar
torr	Unit of measurement Torr
PA	Unit of measurement Pascal

Table 12 – Values for the parameter unit

The unit of measurement is indicated on the display (🔑📖 Figure 11, page 19).

7.3.2 Display Format (diGit)

Number of digits on the display.

Display	Description
2	2 digits, for example 2,5 ⁻¹ or 370

Table 13 – Values for the parameter diGit

7.3.3 Display Brightness (bri)

Display brightness.

Display	Description
H i	High brightness
L o	Low brightness

Table 14 – Values for the parameter bri

7.3.4 Analog Output (AnALoG)

Voltage at the analog output.

Display	Description
H i	Analog output voltage same as at the sensor output
L o	Halved Analog output

Table 15 – Values for the parameter AnA

8. Maintenance and Service

8.1 Maintenance

8.1.1 General Maintenance Information

For external cleaning please use a piece of dry cotton cloth. Do not use any aggressive or abrasive detergents.



DANGER: Mains voltage

The instrument contains inside components at a high voltage. Never introduce any objects into the openings of the instrument. Protect the instrument against moisture. Do not open the instrument.

8.2 Troubleshooting

8.2.1 Fault Indication

A malfunction affecting the multichannel gauge is indicated by an error message on the display. (👉📖 Chapter 8.2.2 Error Messages, page 34)

8.2.2 Error Messages

Error (display)	Fault cause and remedy
<i>Err Lo</i>	Significantly below the measurement range. The Ready relay switches off.
<i>Err Hi</i>	Significantly above the measurement range. The Ready relay switches off.
<i>Err 5</i>	Sensor error. Malfunction affecting the connection to the transmitter. The message will only be displayed in the display field for the affected measurement channel. Acknowledge by pressing any key.
<i>no SEN</i>	No transmitter connected to the measurement channel. The status message disappears after 30 seconds.
<i>notr 16</i>	Error affecting the switch-on or switch-off channel. No switch-on or switch-off threshold has been defined for the PENNINGVAC Transmitter (PTR225 and PTR237 only).

Table 16 – Error messages

8.2.3 Help the Case of Faults

If the malfunction persists even after having replaced the transmitters, please contact your nearest Oerlikon Leybold Vacuum GmbH service office.

8.2.4 Fuse Replacement

To replace blown fuses use only the type of fuse T1.6A H specified on the rear of the instrument. The two fuses of the instrument are located in the fuse insert at the mains filter (👉📖 Figure 6, page 16), which may be levered out using a small screwdriver.

8.2.5 Repair

Send defective products for repair to your nearest Oerlikon Leybold Vacuum GmbH service office. The company Oerlikon Leybold Vacuum GmbH will not assume any responsibility or honour a warranty if the operator or third persons have attempted repair work on the multichannel gauge.

9. Storing and Waste Disposal

9.1 Packaging

Please retain the original packaging. You will need this packaging material when wanting to store the multichannel gauge or when returning it to the company Oerlikon Leybold Vacuum GmbH.

9.2 Waste Disposal

As to waste disposal, the branch-specific and local waste disposal and environment regulations for equipment containing electronic components apply.

When returning the equipment to Oerlikon Leybold Vacuum GmbH, proper and professional separation of the recyclable fraction and its disposal is ensured.

EC Declaration of Conformity

We, Oerlikon Leybold Vacuum GmbH, hereby declare that the products specified and listed below which we have placed on the market, comply with the applicable EC Council Directives.

This declaration becomes invalid if modifications are made to the product without agreement of Oerlikon Leybold Vacuum GmbH.

Compliance with the EMC Directives requires that the components are installed within a system or machine in a manner adapted to EMC requirements.

Designation of the products: **DISPLAY TWO, DISPLAY THREE**

Model: **Dual/Triple Channel Vacuum Display**

The product complies to the following European Council Directives:

- Directive 2006/95/EC related to electrical equipment designed for use within certain voltage limits
- Directive 2004/108/EC relating to electromagnetic compatibility

Related, harmonized standards:

- EN 61010-1 Safety requirements for electrical equipment for measurement, control and laboratory use
- EN 61000-6-2 Electromagnetic compatibility (EMC) - Part 6-2: Generic standards - Immunity for industrial environments
- EN 61000-6-3 Electromagnetic compatibility (EMC) - Part 6-3: Generic standards - Emission standard for residential, commercial and light-industrial environments

Cologne

Cologne 25.09.09



Dr. Monika Mattern-Klosson
Head of Research & Development
Vice President



Harald Udelhoven
Head of Quality Management

Safety information on contamination of compressors, vacuum pumps and components.

Scope

Every employer (user) is held responsible for the health and safety of his employees. This also applies to service personnel performing maintenance work either at the premises of the user or the service company in charge.

By means of the declaration attached the contractor is to be informed about any possible contamination of the compressor, vacuum pump or component sent in for servicing. Based on this information the contractor will be able to take the necessary safety precautions.

Preparation before dispatch

Before shipping any parts, the user must complete the following declaration and add it to the dispatch papers. All dispatch instructions laid down in the manual must be followed e.g.:

- Drain all service fluids
- Remove filter elements
- Seal all openings airtight
- Pack / handle appropriately
- Attach the declaration of contamination **outside** of the packaging

Declaration of Contamination of Compressors, Vacuum Pumps and Components

The repair and / or servicing of compressors, vacuum pumps and components will be carried out only if a correctly completed declaration has been submitted. Non-completion will result in delay. The manufacturer can refuse to accept any equipment without a declaration.

A separate declaration has to be completed for each single component.

This declaration may be completed and signed only by authorized and qualified staff.

Customer/Dep./Institute : _____ Address : _____ _____ Person to contact: _____ Phone : _____ Fax: _____ End user: _____	Reason for return: <input checked="" type="checkbox"/> applicable please mark Repair: <input type="checkbox"/> chargeable <input type="checkbox"/> warranty Exchange: <input type="checkbox"/> chargeable <input type="checkbox"/> warranty <input type="checkbox"/> Exchange already arranged / received Return only: <input type="checkbox"/> rent <input type="checkbox"/> loan <input type="checkbox"/> for credit Calibration: <input type="checkbox"/> DKD <input type="checkbox"/> Factory-calibr. <input type="checkbox"/> Quality test certificate DIN 55350-18-4.2.1
--	--

A. Description of the Leybold product: Material description : _____ Catalog number: _____ Serial number: _____ Type of oil (ForeVacuum-Pumps) : _____	Failure description: _____ _____ Additional parts: _____ Application-Tool: _____ Application- Process: _____
--	--

B. Condition of the equipment	No ¹⁾	Yes	No		Contamination :	No ¹⁾	Yes
1. Has the equipment been used	<input type="checkbox"/>	<input type="checkbox"/>	<input type="checkbox"/>	→	toxic	<input type="checkbox"/>	<input type="checkbox"/>
2. Drained (Product/service fluid)	↓	<input type="checkbox"/>	<input type="checkbox"/>		corrosive	<input type="checkbox"/>	<input type="checkbox"/>
3. All openings sealed airtight	↓	<input type="checkbox"/>	<input type="checkbox"/>		flammable	<input type="checkbox"/>	<input type="checkbox"/>
4. Purged	↓	<input type="checkbox"/>	<input type="checkbox"/>		explosive ²⁾	<input type="checkbox"/>	<input type="checkbox"/>
If yes, which cleaning agent					radioactive ²⁾	<input type="checkbox"/>	<input type="checkbox"/>
and which method of cleaning					microbiological ²⁾	<input type="checkbox"/>	<input type="checkbox"/>
¹⁾ If answered with "No", go to D. ←					other harmful substances	<input type="checkbox"/>	<input type="checkbox"/>

C. Description of processed substances (Please fill in absolutely)																			
1. What substances have come into contact with the equipment ? Trade name and / or chemical term of service fluids and substances processed, properties of the substances According to safety data sheet (e.g. toxic, inflammable, corrosive, radioactive)																			
<table border="1" style="width:100%; border-collapse: collapse;"> <tr> <th style="width:10%;">X</th> <th style="width:40%;">Tradename:</th> <th style="width:50%;">Chemical name:</th> </tr> <tr><td> </td><td> </td><td> </td></tr> <tr><td>a)</td><td> </td><td> </td></tr> <tr><td>b)</td><td> </td><td> </td></tr> <tr><td>c)</td><td> </td><td> </td></tr> <tr><td>d)</td><td> </td><td> </td></tr> </table>	X	Tradename:	Chemical name:				a)			b)			c)			d)			2. Are these substances harmful ? <input type="checkbox"/> No <input type="checkbox"/> Yes 3. Dangerous decomposition products when heated ? <input type="checkbox"/> No <input type="checkbox"/> Yes If yes, which ? _____
X	Tradename:	Chemical name:																	
a)																			
b)																			
c)																			
d)																			

²⁾ Components contaminated by microbiological, explosive or radioactive products/substances will not be accepted without written evidence of decontamination.

D. Legally binding declaration

I / we hereby declare that the information supplied on this form is accurate and sufficient to judge any contamination level.

Name of authorized person (block letters) : _____

_____ Date

_____ signature of authorized person

firm stamp

Sales and Service

Germany

Oerlikon
Leybold Vacuum GmbH
Bonner Strasse 498
D-50968 Cologne
Phone: +49-(0)221-347 1234
Fax: +49-(0)221-347 1245
sales.vacuum@oerlikon.com
www.oerlikon.com

Oerlikon
Leybold Vacuum GmbH
Sales Area North/Northeast
Branch Office Berlin
Buschkrugallee 33
1. Obergeschoss
D-12359 Berlin
Phone: +49-(0)30-435 609 0
Fax: +49-(0)30-435 609 10
sales.vacuum.bn@oerlikon.com

Oerlikon
Leybold Vacuum GmbH
Sales Area South/Southwest
Branch Office Munich
Sendlinger Strasse 7
D-80331 Munich
Phone: +49-(0)89-357 33 9-10
Fax: +49-(0)89-357 33 9-33
sales.vacuum.mn@oerlikon.com
service.vacuum.mn@oerlikon.com

Oerlikon
Leybold Vacuum GmbH
Sales Area West & Benelux
Branch Office Cologne
Bonner Strasse 498
D-50968 Cologne
Phone: +49-(0)221-347 1270
Fax: +49-(0)221-347 1291
sales.vacuum.kn@oerlikon.com

Oerlikon
Leybold Vacuum GmbH
Service Competence Center
Emil-Hoffmann-Strasse 43
D-50996 Cologne-Suerth
Phone: +49-(0)221-347 1439
Fax: +49-(0)221-347 1945
service.vacuum.kn@oerlikon.com

Oerlikon
Leybold Vacuum GmbH
Mobil Customer Service
Emil-Hoffmann-Strasse 43
D-50996 Cologne-Suerth
Phone: +49-(0)221-347 1765
Fax: +49-(0)221-347 1944
service.vacuum.kn@oerlikon.com

Oerlikon
Leybold Vacuum GmbH,
Dresden
Zur Wetterwarte 50, Haus 304
D-01109 Dresden
Service:
Phone: +49-(0)351-88 55 00
Fax: +49-(0)351-88 55 041
info.vacuum.dr@oerlikon.com

Oerlikon
Leybold Vacuum USA Inc.
5700 Mellon Road
USA-Export, PA 15632
Phone: +1-724-327-5700
Fax: +1-724-325-3577
info.vacuum.ex@oerlikon.com

Europe

Belgium
Oerlikon
Leybold Vacuum Nederland B.V.
Belgisch bijkantoor
Leuvensesteenweg 542-9A
B-1930 Zaventem
Sales:
Phone: +32-2-711 00 83
Fax: +32-2-720 83 38
sales.vacuum.zv@oerlikon.com
Service:
Phone: +32-2-711 00 82
Fax: +32-2-720 83 38
service.vacuum.zv@oerlikon.com

France
Oerlikon
Leybold Vacuum France S.A.
7, Avenue du Québec
Z.A. Courtaboef 1 - B.P. 42
F-91942 Courtaboef Cedex
Sales and Service:
Phone: +33-1-69 82 48 00
Fax: +33-1-69 07 57 38
sales.vacuum.or@oerlikon.com

Oerlikon
Leybold Vacuum France S.A.
Valence Factory
640, Rue A. Bergès - B.P. 107
F-26501 Bourg-lès-Valence Cedex
Phone: +33-4-75 82 33 00
Fax: +33-4-75 82 92 69
info.vacuum.vc@oerlikon.com

Great Britain
Oerlikon
Leybold Vacuum UK Ltd.
Unit 2
Silverglade Business Park
Leatherhead Road
UK-Chessington, Surrey KT9 2QL
Sales:
Phone: +44-13-7273 7300
Fax: +44-13-7273 7301
sales.vacuum.ln@oerlikon.com
Service:
Phone: +44-20-8971 7030
Fax: +44-20-8971 7003
service.vacuum.ln@oerlikon.com

Italy
Oerlikon
Leybold Vacuum Italia S.p.A.
8, Via Trasimeno
I-20128 Milano
Sales:
Phone: +39-02-27 22 31
Fax: +39-02-27 20 96 41
sales.vacuum.mi@oerlikon.com
Service:
Phone: +39-02-27 22 31
Fax: +39-02-27 22 32 17
service.vacuum.mi@oerlikon.com

Oerlikon
Leybold Vacuum Italia S.p.A.
Field Service Base
Z.I. Le Capanne
I-05021 Acquasparta (TR)
Phone: +39-0744-93 03 93
Fax: +39-0744-94 42 87
service.vacuum.mi@oerlikon.com

Netherlands
Oerlikon
Leybold Vacuum Nederland B.V.
Proostwetering 24N
NL-3543 AE Utrecht
Sales and Service:
Phone: +31-(30) 242 6330
Fax: +31-(30) 242 6331
sales.vacuum.ut@oerlikon.com
service.vacuum.ut@oerlikon.com

Spain
Oerlikon
Leybold Vacuum Spain, S.A.
C/. Huelva, 7
E-08940 Cornellà de Llobregat
(Barcelona)
Sales:
Phone: +34-93-666 46 16
Fax: +34-93-666 43 70
sales.vacuum.ba@oerlikon.com
Service:
Phone: +34-93-666 49 51
Fax: +34-93-685 40 10
service.vacuum.ba@oerlikon.com

Sweden
Oerlikon
Leybold Vacuum Scandinavia AB
Box 9084
SE-40092 Göteborg
Sales and Service:
Phone: +46-31-68 84 70
Fax: +46-31-68 39 39
info.vacuum.gt@oerlikon.com
Visiting/delivery address:
Datavägen 57B
SE-43632 Askim

Switzerland
Oerlikon
Leybold Vacuum Schweiz AG
Leutschenbachstrasse 55
CH-8050 Zürich
Sales:
Phone: +41-044-308 40 50
Fax: +41-044-302 43 73
sales.vacuum.zh@oerlikon.com
Service:
Phone: +41-044-308 40 62
Fax: +41-044-308 40 60
service.vacuum.zh@oerlikon.com

America

USA
Oerlikon
Leybold Vacuum USA Inc.
5700 Mellon Road
USA-Export, PA 15632
Phone: +1-724-327-5700
Fax: +1-724-325-3577
info.vacuum.ex@oerlikon.com

Sales:
Eastern & Central time zones
Phone: +1-724-327-5700
Fax: +1-724-333-1217
Pacific, Mountain, Alaskan &
Hawaiian time zones
Phone: +1-480-752-9191
Fax: +1-480-752-9494
Service:
Phone: +1-724-327-5700
Fax: +1-724-325-3577

Oerlikon
Leybold Vacuum GmbH
Bonner Strasse 498
D-50968 Cologne
Phone: +49-(0)221-347 0
Fax: +49-(0)221-347 1250
info.vacuum@oerlikon.com

Asia

P.R. China
Oerlikon
Leybold Vacuum (Tianjin)
International Trade Co. Ltd.
Beichen Economic
Development Area (BEDA),
Shanghai Road
Tianjin 300400
China
Sales and Service:
Phone: +86-22-2697 0808
Fax: +86-22-2697 4061
Fax: +86-22-2697 2017
sales.vacuum.tj@oerlikon.com
service.vacuum.tj@oerlikon.com

Oerlikon
Leybold Vacuum
(Tianjin) Co. Ltd.
Beichen Economic
Development Area (BEDA),
Shanghai Road
Tianjin 300400
China
Sales and Service:
Phone: +86-22-2697 0808
Fax: +86-22-2697 4061
Fax: +86-22-2697 2017
info.vacuum.tj@oerlikon.com
service.vacuum.tj@oerlikon.com

Oerlikon
Leybold Vacuum (Tianjin)
International Trade Co. Ltd.
Shanghai Branch:
Add: No.33
76 Futedong San Rd.
Waigaoqiao FTZ
Shanghai 200131
China
Sales and Service:
Phone: +86-21-5064-4666
Fax: +86-21-5064-4668
info.vacuum.sh@oerlikon.com
service.vacuum.tj@oerlikon.com

Oerlikon
Leybold Vacuum (Tianjin)
International Trade Co. Ltd.
Guangzhou Office and
Service Center
1st F, Main Building
Science City Plaza,
No.111 Science Revenue,
Guangzhou Science City
(GZSC) 510663, Guangzhou,
China
Sales:
Phone: +86-20-8723-7873
Phone: +86-20-8723-7597
Fax: +86-20-8723-7875
info.vacuum.gz@oerlikon.com
service.vacuum.tj@oerlikon.com

Oerlikon
Leybold Vacuum (Tianjin)
International Trade Co. Ltd.
Beijing Branch:
1-908, Beijing Landmark Towers
8 North Dongsanhuan Road
Chaoyang District
Beijing 100004
China
Sales:
Phone: +86-10-6590-7622
Fax: +86-10-6590-7607
sales.vacuum.bj@oerlikon.com

India
Oerlikon
Leybold Vacuum India Pvt Ltd.
EL-22, J Block
MIDC Bhosari
Pune 411026
India
Sales and Service:
Phone: +91-20-3061 60000
Fax: +91-20-2712 1571
sales.vacuum.pu@oerlikon.com
service.vacuum.pu@oerlikon.com

Japan
Oerlikon
Leybold Vacuum
Japan Co., Ltd.
Headquarter
23-3, Shin-Yokohama
3-chome
Tobu A.K. Bldg. 4th Floor
Kohoku-ku
Yokohama-shi 222-0033
Sales:
Phone: +81-45-471-3330
Fax: +81-45-471-3323
info.vacuum.yh@oerlikon.com
sales.vacuum.yh@oerlikon.com

Oerlikon
Leybold Vacuum
Japan Co., Ltd.
Osaka Sales Office
5-13, Kawagishi-machi
Suita-chi
Osaka 564-0037
Phone: +81-6-6393-5211
Fax: +81-6-6393-5215
info.vacuum.os@oerlikon.com
sales.vacuum.os@oerlikon.com

Oerlikon
Leybold Vacuum
Japan Co., Ltd.
Tsukuba Technical Service Center
Kogyo Danchi
21, Kasuminosato,
Ami-machi, Inashiki-gun
Ibaraki-ken, 300-0315
Service:
Phone: +81-298 89 2841
Fax: +81-298 89 2838
info.vacuum.iik@oerlikon.com
sales.vacuum.iik@oerlikon.com

Korea
Oerlikon
Leybold Vacuum Korea Ltd.
3F, Jellzone 2 Tower, 159-4
Jeongja-Dong, Bundang-Gu
Seongnam-Si, Gyeonggi-Do
Korea 463-384
Sales:
Phone: +82-31 785 1367
Fax: +82-31 785 1359

623-7, Upsung-Dong
Cheonan-Si
Chungcheongnam-Do
Korea 330-290
Service:
Phone: +82-41 589 3035
Fax: +82-41 588 0166

Singapore
Oerlikon
Leybold Vacuum
Singapore Pte Ltd.
1 Science Park Road
Singapore Science
Park 2
#02-12, Capricorn Building
Singapore 117528
Sales and Service:
Phone: +65-6303 7000
Fax: +65-6773 0039
sales.vacuum.sg@oerlikon.com
service.vacuum.sg@oerlikon.com

Taiwan
Oerlikon
Leybold Vacuum Taiwan Ltd.
No 416-1, Sec. 3
Chung-Hsin Rd., Chu-Tung
Hsin-Chu, Taiwan, R.O.C.
Sales and Service:
Phone: +886-3-500 1688
Fax: +886-3-583 3999
sales.vacuum.hc@oerlikon.com
service.vacuum.hc@oerlikon.com

oerlikon
leybold vacuum

www.oerlikon.com