



OPERATING INSTRUCTIONS

EN

Translation of the Original

TPG 366 MAXIGAUGE

Total pressure measuring and control unit

Dear Customer,

Thank you for choosing a Pfeiffer Vacuum product. Your new total pressure measuring and control unit should support you in your individual application with full performance and without malfunctions. The name Pfeiffer Vacuum stands for high-quality vacuum technology, a comprehensive and complete range of top-quality products and first-class service. From this extensive, practical experience we have gained a large volume of information that can contribute to efficient deployment and to your personal safety.

In the knowledge that our product must avoid consuming work output, we trust that our product can offer you a solution that supports you in the effective and trouble-free implementation of your individual application.

Please read these operating instructions before putting your product into operation for the first time. If you have any questions or suggestions, please feel free to contact **info@pfeiffer-vacuum.de**.

Further operating instructions from Pfeiffer Vacuum can be found in the [Download Center](#) on our website.

Disclaimer of liability

These operating instructions describe all models and variants of your product. Note that your product may not be equipped with all features described in this document. Pfeiffer Vacuum constantly adapts its products to the latest state of the art without prior notice. Please take into account that online operating instructions can deviate from the printed operating instructions supplied with your product.

Furthermore, Pfeiffer Vacuum assumes no responsibility or liability for damage resulting from the use of the product that contradicts its proper use or is explicitly defined as foreseeable misuse.

Copyright

This document is the intellectual property of Pfeiffer Vacuum and all contents of this document are protected by copyright. They may not be copied, altered, reproduced or published without the prior written permission of Pfeiffer Vacuum.

We reserve the right to make changes to the technical data and information in this document.

Table of contents

1	About this manual	7
1.1	Validity	7
	1.1.1 Applicable documents	7
	1.1.2 Variants	7
	1.1.3 Firmware versions	7
1.2	Target group	7
1.3	Conventions	8
	1.3.1 Instructions in the text	8
	1.3.2 Pictographs	8
	1.3.3 Stickers on the product	8
	1.3.4 Abbreviations	8
1.4	Trademarks	9
2	Safety	10
2.1	General safety instructions	10
2.2	Safety instructions	10
2.3	Safety precautions	14
2.4	Proper use	15
2.5	Foreseeable improper use	15
2.6	Responsibilities and warranty	15
2.7	Owner requirements	15
2.8	Personnel qualification	15
	2.8.1 Ensuring personnel qualification	16
	2.8.2 Personnel qualification for maintenance and repair	16
	2.8.3 Advanced training with Pfeiffer Vacuum	16
2.9	Operator requirements	17
3	Transportation and storage	18
4	Product description	19
4.1	Identifying the product	19
4.2	Scope of delivery	19
4.3	Structure	19
4.4	Display elements	20
4.5	Controls	22
4.6	Interfaces	23
	4.6.1 Mains power supply	23
	4.6.2 Ground terminal	23
	4.6.3 "sensor" connection	24
	4.6.4 "control" connection	24
	4.6.5 "relay" connection	25
	4.6.6 Connection "RS-485"	25
	4.6.7 "USB" connection (type B)	26
	4.6.8 "USB" connection (type A)	26
	4.6.9 "Ethernet" (LAN) connection	26
5	Installation	28
5.1	Installing the device in a 19" rack	28
5.2	Installing the device in a switchboard	29
5.3	Using the device as a desktop device	30
6	Commissioning	31
6.1	Switch on the device	31
6.2	Updating the firmware	31
6.3	Configuring Ethernet	33
7	Operation	36

7.1	Basic operation	36
7.2	Operating modes	36
7.3	Measuring mode	36
7.4	Parameter mode	38
	7.4.1 Switching function parameters	40
	7.4.2 Gauge parameters	42
	7.4.3 Gauge control	44
	7.4.4 General parameters	45
	7.4.5 Test parameters	49
7.5	Data logger mode	52
7.6	Setup mode	53
8	Decommissioning	55
9	Maintenance	56
	9.1 Cleaning the device	56
	9.2 Replacing the battery	57
10	Errors	58
11	Shipping	59
12	Disposal	60
13	Service solutions from Pfeiffer Vacuum	61
14	Technical data and dimensions	63
	14.1 Technical data	63
	14.2 Dimensions	67
15	Appendix	68
	15.1 Units of pressure	68
	15.2 Gas throughputs	68
	ETL Listed	69
	Declaration of conformity	70

List of tables

Tbl. 1:	Applicable documents.....	7
Tbl. 2:	Variants.....	7
Tbl. 3:	Abbreviations used.....	9
Tbl. 4:	Danger to life due to electric voltage.....	11
Tbl. 5:	Controls.....	22
Tbl. 6:	Switching functions.....	25
Tbl. 7:	Status of the Ethernet connection.....	27
Tbl. 8:	Description of the controls.....	36
Tbl. 9:	Switching function parameters.....	40
Tbl. 10:	Examples of switching function displays.....	40
Tbl. 11:	Upper and lower threshold values.....	41
Tbl. 12:	Gauge parameters.....	42
Tbl. 13:	Available parameters (gauge parameters).....	42
Tbl. 14:	Gauge control.....	44
Tbl. 15:	Available parameters (gauge control).....	44
Tbl. 16:	Switch-on type (SENSOR ON).....	44
Tbl. 17:	Switch-off type (SENSOR OFF).....	45
Tbl. 18:	Switch on/off thresholds.....	45
Tbl. 19:	General parameters.....	46
Tbl. 20:	Available parameters (general parameters).....	46
Tbl. 21:	Test parameters.....	50
Tbl. 22:	Parameters in data logger mode.....	52
Tbl. 23:	Parameters in setup mode.....	53
Tbl. 24:	Errors.....	58
Tbl. 25:	Technical data (general).....	63
Tbl. 26:	Technical data (mains connection).....	63
Tbl. 27:	Technical data (ambient conditions).....	63
Tbl. 28:	Technical data (gauge connections).....	64
Tbl. 29:	Technical data (gauge supply).....	64
Tbl. 30:	Technical data (operation).....	64
Tbl. 31:	Technical data (measured values).....	65
Tbl. 32:	Technical data (switching functions).....	65
Tbl. 33:	Technical data (switching function relay).....	65
Tbl. 34:	Technical data (error signal (error)).....	65
Tbl. 35:	Technical data (error signal relay).....	65
Tbl. 36:	Technical data (gauge control).....	66
Tbl. 37:	Technical data (analog outputs).....	66
Tbl. 38:	Technical data (RS-485 interface).....	66
Tbl. 39:	Technical data (USB interface (type A)).....	66
Tbl. 40:	Technical data (USB interface (type B)).....	67
Tbl. 41:	Technical data (Ethernet interface).....	67
Tbl. 42:	Units of pressure and their conversion.....	68
Tbl. 43:	Gas throughputs and their conversion.....	68

List of figures

Fig. 1:	Disconnect device in accordance with EN 61010-1.....	11
Fig. 2:	Front panel.....	19
Fig. 3:	Connections on the rear side.....	20
Fig. 4:	Display.....	21
Fig. 5:	Parameter or bar graph.....	21
Fig. 6:	Switch-points, parameter mode and input lock.....	21
Fig. 7:	Measurement channel status.....	22
Fig. 8:	Mains connection with IEC 320 C13 socket.....	23
Fig. 9:	Gauge connection (6-pin Amphenol C 091 B socket).....	24
Fig. 10:	"control" connection (15-pole D-Sub socket).....	24
Fig. 11:	"relay" connection (25-pole D-Sub socket).....	25
Fig. 12:	"RS-485" connection (5-pole Binder M12 socket).....	26
Fig. 13:	"USB" connection (type B).....	26
Fig. 14:	"USB" connection (type A).....	26
Fig. 15:	"Ethernet" (LAN) connection.....	26
Fig. 16:	Guide rails.....	28
Fig. 17:	Rack module adapter (3 height units).....	28
Fig. 18:	Device installation.....	29
Fig. 19:	Required control panel cut-out.....	29
Fig. 20:	Fastening the rubber feet and rubber strip.....	30
Fig. 21:	USB Update Tool.....	32
Fig. 22:	Ethernet Configuration Tool.....	34
Fig. 23:	Change measurement channel.....	37
Fig. 24:	Switching gauges on and off.....	37
Fig. 25:	Measuring range.....	37
Fig. 26:	Identifying the gauge.....	38
Fig. 27:	Change from measuring mode to parameter mode.....	38
Fig. 28:	Select parameter group.....	38
Fig. 29:	Read/write parameter groups and parameters.....	39
Fig. 30:	Switching functions and threshold values.....	41
Fig. 31:	Fast, normal and slow (from left to right).....	43
Fig. 32:	Press the arrow keys simultaneously > 2 seconds.....	49
Fig. 33:	Program memory test.....	50
Fig. 34:	Parameter memory test.....	51
Fig. 35:	Display test.....	51
Fig. 36:	Test of relays in the device.....	51
Fig. 37:	Start/stop measured data recording.....	53
Fig. 38:	Delete files.....	53
Fig. 39:	Formatting the USB memory stick.....	54
Fig. 40:	Delete parameter files from the USB memory stick.....	54
Fig. 41:	Dimensions TPG 366 (in mm).....	67

1 About this manual



IMPORTANT

Read carefully before use.
Keep the manual for future consultation.

1.1 Validity

This document describes the function of the products listed in the following and provides the most important information for safe use. The description is written in accordance with the valid directives. The information in this document refers to the current development status of the products. The document retains its validity assuming that the customer does not make any changes to the product.

1.1.1 Applicable documents

Designation	Document
“Measuring and control unit” communication instructions TPG 366	BG 5511
“Gauges” operating instructions ActiveLine gauge	(depending on the gauge used)
Declaration of conformity	(Part of this document)

Tbl. 1: Applicable documents

1.1.2 Variants

This document applies for the product with the following part number:

Part number	Designation
PT G28 770	TPG 366 MaxiGauge

Tbl. 2: Variants

The part number is found on the rating plate of the product.

Pfeiffer Vacuum reserves the right to make technical changes without prior notification.

The figures in this document are not to scale (dimensions in mm).

1.1.3 Firmware versions

This document is based on firmware version **V010100**.

Older firmware versions do not have the full functionality described in these operating instructions.

Checking the firmware version

1. If the device is not functioning as it did before, check whether the correct firmware version is installed.
2. If you have any questions about the firmware, contact Pfeiffer Vacuum.

1.2 Target group

This operating instructions are aimed at all persons performing the following activities on the product:

- transport,
- setup (installation),
- usage and operation,
- decommissioning,
- maintenance and cleaning,

- storage or disposal.

The work described in this document is only permitted to be performed by persons with the appropriate technical qualifications (expert personnel) or who have received the relevant training from Pfeiffer Vacuum.

1.3 Conventions

1.3.1 Instructions in the text

Usage instructions in the document follow a general structure that is complete in itself. The required action is indicated by an individual step or multi-part action steps.

Individual action step

A horizontal, solid triangle indicates the only step in an action.

- ▶ This is an individual action step.

Sequence of multi-part action steps

The numerical list indicates an action with multiple necessary steps.

1. Step 1
2. Step 2
3. ...

1.3.2 Pictographs

Pictographs used in the document indicate useful information.



Note



Tip

1.3.3 Stickers on the product

This section describes all the stickers on the product along with their meaning.

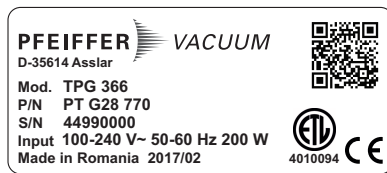
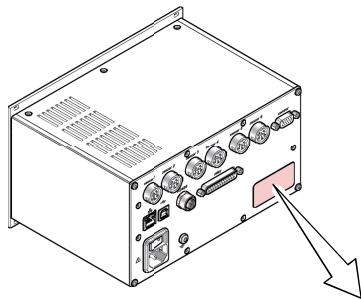

Rating plate

The rating plate is located on the back of the device.

1.3.4 Abbreviations

Abbreviation	Explanation
A/D	Analog/Digital
F.S.	Full Scale (limit value)

Abbreviation	Explanation
FSR	Full Scale Range (upper range value)
SP	Switch-point (setpoint)
UART	Universal Asynchronous Receiver Transmitter

Tbl. 3: Abbreviations used

1.4 Trademarks

- FullRange® is a trademark of Pfeiffer Vacuum GmbH.
- MaxiGauge® is a trademark of Pfeiffer Vacuum GmbH.

2 Safety

2.1 General safety instructions

This document includes the following four risk levels and one information level.

⚠ DANGER
<p>Imminent danger Indicates a hazardous situation which, if not avoided, will result in death or serious injury.</p> <ul style="list-style-type: none"> ▶ Instructions on avoiding the hazardous situation
⚠ WARNING
<p>Possibly imminent danger Indicates a hazardous situation which, if not avoided, could result in death or serious injury.</p> <ul style="list-style-type: none"> ▶ Instructions on avoiding the hazardous situation
⚠ CAUTION
<p>Possibly imminent danger Indicates a hazardous situation which, if not avoided, could result in minor or moderate injury.</p> <ul style="list-style-type: none"> ▶ Instructions on avoiding the hazardous situation
NOTICE
<p>Danger of property damage Notice is used to address practices not related to physical injury.</p> <ul style="list-style-type: none"> ▶ Instructions on avoiding property damage



Notes, tips or examples indicate important information on the product or on this document.

2.2 Safety instructions



Safety instructions according to product's life stages
All safety instructions in this document are based on the results of a risk assessment. Pfeiffer Vacuum has taken into account all the relevant life stages of the product.

Danger to life due to electric voltage**⚠ DANGER****Danger to life due to electric voltage**

High voltages are present inside the device. When touching parts that are live, there is a risk of death. If there is visible damage, there is a risk of death when commissioning the device.

- ▶ Work on the open device must only be carried out by trained specialist personnel.
- ▶ Before carrying out any installation and maintenance work, switch the device off and disconnect it from the current supply.
 - After switching off, wait about 60 seconds and then disconnect all cables (power cable at the end).
- ▶ Never open the device with the current supply connected.
- ▶ Secure the current supply against unauthorized or unintentional reactivation.
- ▶ Do not insert any objects into the vent openings.
- ▶ Never open an external power supply unit.
- ▶ Never operate an open or defective device.
- ▶ Secure a defective device against accidental operation.
- ▶ Protect the device against moisture.

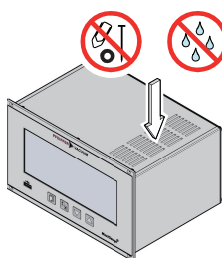

Do not insert any objects into the vent openings.



Protect the device against moisture.

Tbl. 4: Danger to life due to electric voltage

Disconnect device

The disconnect device must be clearly recognizable by the user and within easy reach.

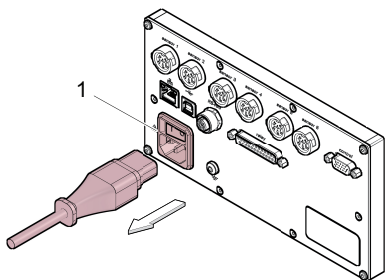

Fig. 1: Disconnect device in accordance with EN 61010-1

1 Disconnect device

Risks during transport**NOTICE****Damage caused by incorrect transportation**

Transportation in unsuitable packaging, or failure to install all transport locks, can damage the product.

- ▶ Comply with the instructions for safe transportation.

Risks during storage

NOTICE

Damage caused by improper storage
 Improper storage will lead to damage to the product.
 Static charging, moisture, etc. lead to defects on the electronic components.

- ▶ Comply with the instructions for safe storage.

Risks during installation

⚠ DANGER

Danger to life from electric shock
 The internal earthed conductor is fastened to the housing by a screw. A device without an earthed conductor attached can be life-threatening in the event of a malfunction.

- ▶ Do not rotate or loosen the screw on the internal earthed conductor.

⚠ DANGER

Danger to life due to dangerous contact voltage
 Voltages above 30 V (AC) or 60 V (DC) are considered dangerous in accordance with EN 61010. If you come into contact with dangerous contact voltage, this can result in injury through electric shocks or even death.

- ▶ Only apply protected extra-low voltage (PELV).

⚠ DANGER

Risk to life due to electric shock
 An improperly earthed unit is a potential threat to life in the event of a fault.

- ▶ Conduct the electrical connection in accordance with locally applicable regulations.
- ▶ Make sure that the local mains voltage and frequency match rating plate specifications.
- ▶ Use only a 3-pin mains cable and extension cables with properly connected protective earthing (earthed conductor).
- ▶ Plug the mains plug into a socket with earthing contact only.
 - Protection must not be impaired by an extension with no earthed conductor.
- ▶ Always connect the mains cable prior to all other cables, to ensure continuous protective earthing.
 - In reverse: always disconnect all other cables prior to disconnecting the mains cable.

NOTICE

Loss of control cabinet protection class
 As a built-in unit, the device can negate the required protection class (protection against foreign matter and water) of control cabinets according to EN 60204-1, for example.

- ▶ Take suitable measures to reestablish the required protection class.

NOTICE

Damage caused by penetrating moisture
 Penetrating moisture, e.g. through condensation or dripping water, damages the device.

- ▶ Protect the device against moisture penetrating.
- ▶ Only operate the device in a clean and dry environment.
- ▶ Operate the device away from fluids and humidity sources.
- ▶ Take special precautions if there is a risk of dripping water.
- ▶ Do not switch on the device if fluid has penetrated into it, instead contact the Pfeiffer Vacuum Service Center.

NOTICE**Damage caused by overheating**

The ambient temperature must not exceed the permissible operating temperature of the device.

- ▶ Make sure there is unobstructed circulation of air when installing the device.
- ▶ Make sure that air can enter and exit through the ventilation openings without obstruction.
- ▶ Do not cover the ventilation openings.
- ▶ Periodically check and clean the installed air filter.

Risks during operation**⚠ DANGER****Electric shocks due to moisture penetrating into the device**

Water that has penetrated into the device results in personal injury through electric shocks.

- ▶ Only operate the device in a dry environment.
- ▶ Operate the device away from fluids and humidity sources.
- ▶ Do not switch on the device if fluid has penetrated into it, instead contact Pfeiffer Vacuum Service.
- ▶ Always disconnect the current supply before cleaning the device.

NOTICE**Unintentional results with controller connected**

Switch relay not dependent on pressure. Values below the intended measuring range, or starting the test program, can result in unintentional results at the connected controller, if the relay switches.

- ▶ Unplug the connected measuring and control cable.
- ▶ Prevent triggering of incorrect control commands or messages.

Risks during maintenance**⚠ DANGER****Danger to life due to electric voltage**

High voltages are present inside the device. When touching parts that are live, there is a risk of death. If there is visible damage, there is a risk of death when commissioning the device.

- ▶ Work on the open device must only be carried out by trained specialist personnel.
- ▶ Before carrying out any installation and maintenance work, switch the device off and disconnect it from the current supply.
 - After switching off, wait about 60 seconds and then disconnect all cables (power cable at the end).
- ▶ Never open the device with the current supply connected.
- ▶ Secure the current supply against unauthorized or unintentional reactivation.
- ▶ Do not insert any objects into the vent openings.
- ▶ Never open an external power supply unit.
- ▶ Never operate an open or defective device.
- ▶ Secure a defective device against accidental operation.
- ▶ Protect the device against moisture.

⚠ WARNING**Health hazard through poisoning from toxic contaminated components or devices**

Toxic process media result in contamination of devices or parts of them. During maintenance work, there is a risk to health from contact with these poisonous substances. Illegal disposal of toxic substances causes environmental damage.

- ▶ Take suitable safety precautions and prevent health hazards or environmental pollution by toxic process media.
- ▶ Decontaminate affected parts before carrying out maintenance work.
- ▶ Wear protective equipment.

⚠ WARNING

Health hazards due to cleaning agent
 The cleaning agents used cause health hazards.

- ▶ When handling cleaning agents, observe the applicable regulations.
- ▶ Adhere to safety measures regarding handling and disposal of cleaning agents.
- ▶ Be aware of potential reactions with product materials.

NOTICE

Damage caused by unsuitable cleaning agents
 Unsuitable cleaning agents damage the product.

- ▶ Do not use solvents as they attack the surface.
- ▶ Do not use any aggressive or abrasive cleaning agents.

Risks when shipping

⚠ WARNING

Risk of poisoning from contaminated products
 Where products that contain harmful substances are shipped for maintenance or repair purposes, the safety of service personnel is at risk.

- ▶ Comply with the instructions for safe shipping.

Risks during disposal

⚠ CAUTION

Health hazard caused by environmentally hazardous substances
 Products, operating fluid, electric components, calibration gas residues (for example from test leaks) or similar pose health hazards.

- ▶ Dispose of the environmentally hazardous substances in accordance with local regulations.
- ▶ Dispose of calibration gas and test leaks in accordance with local regulations.

2.3 Safety precautions

The product is designed according to the latest technology and recognized safety engineering rules. Nevertheless, improper use can result in danger to operator all third party life and limb, and product damage and additional property damage.



Duty to provide information on potential dangers
 The product holder or user is obliged to make all operating personnel aware of dangers posed by this product.
 Every person who is involved in the installation, operation or maintenance of the product must read, understand, and adhere to the safety-related parts of this document.



Infringement of EU conformity due to modifications to the product
 The Declaration of Conformity from the manufacturer is no longer valid if the operator changes the original product or installs additional equipment.

- Following installation into a system, the operator is required to check and re-evaluate as necessary the conformity of the overall system in the context of the relevant EU Directives before commissioning that system.

Meet fundamental safety measures

1. When handling the gases and contaminated parts used, observe the applicable guidelines.
2. Observe the protective measures.
3. Observe the safety guidelines specified in this document.

- All work is only permissible when observing the relevant guidelines and adhering to the protective measures.
4. Inform yourself about any contamination before starting work.
 5. Pass on safety instructions to all other users.

2.4 Proper use

The total pressure measuring gauge and control unit are used together with the Pfeiffer Vacuum Active-Line gauges to measure total pressures. Typical applications are measurement, monitoring and process control tasks in vacuum systems.

Using the product according to its intended purpose

1. Install, operate and maintain the product only in accordance with these operating instructions.
2. Comply with the application limits.
3. Observe the technical data.

2.5 Foreseeable improper use

Improper use of the product invalidates all warranty and liability claims. Improper use is any, even unintended, use, which is contrary to the product purpose; and in particular:

- Use outside the mechanical and electrical application limits (technical data)
- Use with corrosive or explosive media, if this is not explicitly permitted
- Use outdoors
- Use after technical changes (inside or outside on the product)
- Use with replacement or accessory parts that are inadequate or are not approved

2.6 Responsibilities and warranty

Pfeiffer Vacuum shall assume no responsibilities and warranty if the operating company or a third party::

- disregards this document.
- does not use the product for its intended purpose.
- carries out any modifications to the product (conversions, changes, maintenance work, etc.) that are not listed in the corresponding product documentation.
- operates the product with accessories that are not listed in the corresponding product documentation.

The operator is responsible for the process media used.

2.7 Owner requirements

Safety-conscious working

1. Only operate the product in a technically flawless state.
2. Operate the product in line with its intended purpose, safety and hazard-conscious as well as when observing the operating instructions.
3. Fulfill the following guidelines and monitor their observation:
 - Proper use
 - Generally applicable safety instructions and accident prevention regulations
 - International, national and locally applicable standards and guidelines
 - Additional product-related guidelines and regulations
4. Only use original parts or parts approved by Pfeiffer Vacuum.
5. Keep the operating instructions available at the place of installation.
6. Ensure personnel qualification.

2.8 Personnel qualification

The work described in this document may only be carried out by persons who have appropriate professional qualifications and the necessary experience or who have completed the necessary training as provided by Pfeiffer Vacuum.

Training people

1. Train the technical personnel on the product.
2. Only let personnel to be trained work with and on the product when under the supervision of trained personnel.
3. Only allow trained technical personnel to work with the product.
4. Before starting work, make sure that the commissioned personnel have read and understood these operating instructions and all applicable documents, in particular the safety, maintenance and repair information.

2.8.1 Ensuring personnel qualification

Specialist for mechanical work

Only a trained specialist may carry out mechanical work. Within the meaning of this document, specialists are people responsible for construction, mechanical installation, troubleshooting, and maintenance of the product, and who have the following qualifications:

- Qualification in the mechanical field in accordance with nationally applicable regulations
- Knowledge of this documentation

Specialist for electrical engineering work

Only a trained electrician may carry out electrical engineering work. Within the meaning of this document, electricians are people responsible for electrical installation, commissioning, troubleshooting, and maintenance of the product, and who have the following qualifications:

- Qualification in the electrical engineering field in accordance with nationally applicable regulations
- Knowledge of this documentation

In addition, these individuals must be familiar with applicable safety regulations and laws, as well as the other standards, guidelines, and laws referred to in this documentation. The above individuals must have expressly granted operational authorization, to commission, program, configure, mark, and earth devices, systems, and circuits in accordance with safety technology standards.

Trained individuals

Only adequately trained individuals may carry out all works in other transport, storage, operation, and disposal fields. Such training must ensure that individuals are capable of carrying out the required activities and work steps safely and properly.

2.8.2 Personnel qualification for maintenance and repair



Advanced training courses

Pfeiffer Vacuum offered advanced training courses to maintenance levels II and III.

Adequately trained individuals are:

- **Maintenance level I**
 - Customer (trained specialist)
- **Maintenance level II**
 - Customer with technical education
 - Pfeiffer Vacuum service technician
- **Maintenance level III**
 - Customer with Pfeiffer Vacuum service training
 - Pfeiffer Vacuum service technician

2.8.3 Advanced training with Pfeiffer Vacuum

For optimal and trouble-free use of this product, Pfeiffer Vacuum offers a comprehensive range of courses and technical training.

For more information, please contact [Pfeiffer Vacuum technical training](#).

2.9 Operator requirements

Observing relevant documents and data

1. Read, observe and follow this operating instructions and the work instructions prepared by the operating company, in particular the safety and warning instructions.
2. Install, operate and maintain the product only in accordance with these operating instructions.
3. Carry out all work only on the basis of the complete operating instructions and applicable documents.
4. Comply with the application limits.
5. Observe the technical data.
6. Please contact the Pfeiffer Vacuum Service Center if your questions on operation or maintenance of the product are not answered by this operating manual.
 - You can find information in the [Pfeiffer Vacuum service area](#).

3 Transportation and storage

NOTICE

Damage caused by incorrect transportation

Transportation in unsuitable packaging, or failure to install all transport locks, can damage the product.

- ▶ Comply with the instructions for safe transportation.

NOTICE

Damage caused by improper storage

Improper storage will lead to damage to the product.

Static charging, moisture, etc. lead to defects on the electronic components.

- ▶ Comply with the instructions for safe storage.

Instructions for safe transportation

1. Observe the weight of the product (see technical data).
2. Where possible, always transport or ship the product in the original packaging.
3. Always use dense and impact-proof packaging for the product.
4. Only remove the present protective cover immediately prior to installation.
5. Reattach transport locks prior to every transport.

Instructions for safe storage

1. Store the product in a cool, dry, dust-free place, where it is protected against impacts and mechanical vibration.
2. Always use dense and impact-proof packaging for the product.
3. Where possible, store the product in the original packaging.
4. Store electronic components in antistatic packaging.
5. Maintain the permissible storage temperature.
6. Avoid extreme fluctuations of the ambient temperature.
7. Avoid high air humidity.
8. Seal connections with the original protective caps.
9. Protect the product with the original transport protections (where available).

4 Product description

4.1 Identifying the product

You will need all the data from the rating plate to safely identify the product when communicating with Pfeiffer Vacuum.

Recording rating plate data

1. Read the data on the product rating plate.
2. Record this data.
3. Always have all rating plate specifications to hand.

4.2 Scope of delivery

The shipment includes the following parts:

- 1 × total pressure measuring and control unit
- 1 × network cable
- 4 × collar screws with synthetic nipple
- 2 × rubber feet
- 1 × rubber strip
- 1 × installation instructions
- 1 × operating instructions

Unpacking the product and checking completeness of the shipment

1. Unpack the product.
2. Remove transport seals, transport locks, etc. and store them.
3. Check that the shipment is complete.
4. Ensure that no parts are damaged.

4.3 Structure

⚠ DANGER

Danger to life from electric shock

The internal earthed conductor is fastened to the housing by a screw. A device without an earthed conductor attached can be life-threatening in the event of a malfunction.

► Do not rotate or loosen the screw on the internal earthed conductor.

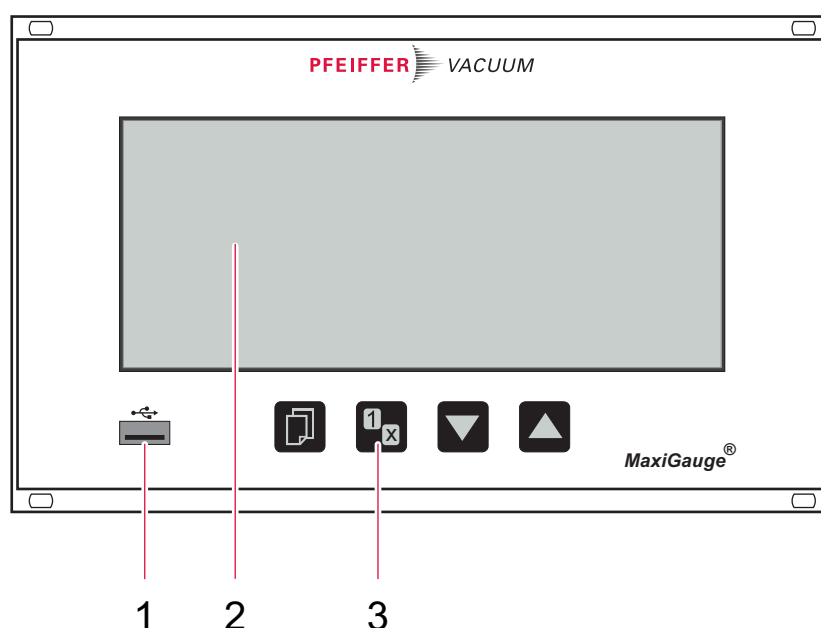

Fig. 2: Front panel

- 1 USB connection (type A)
- 2 Display
- 3 Controls

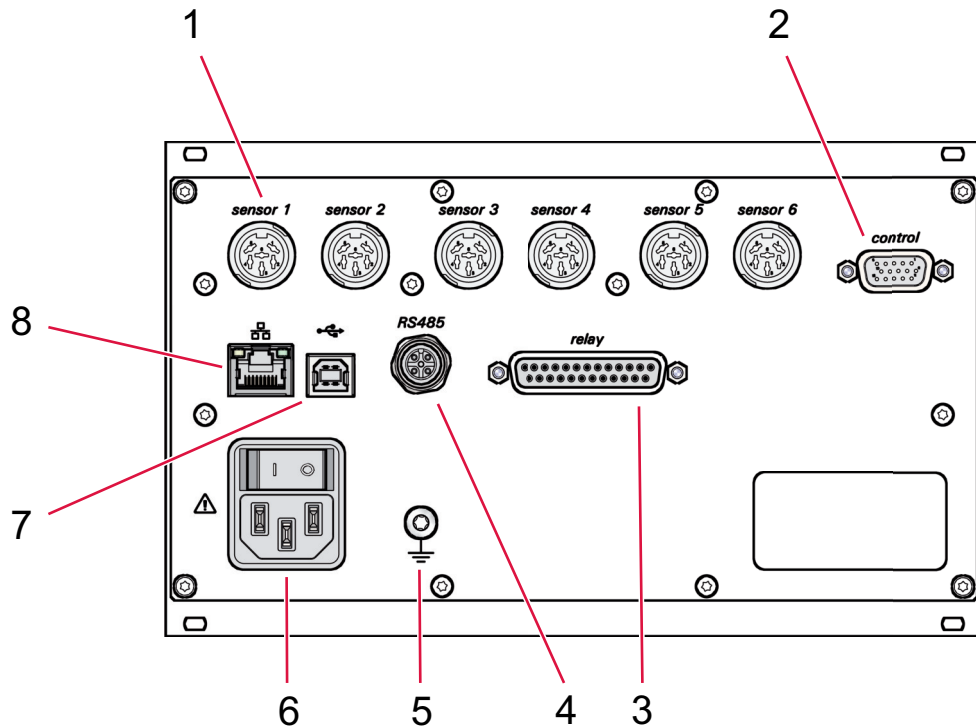

Fig. 3: Connections on the rear side

- 1 Connections "sensor 1" to "sensor 6" for gauges
- 2 "control" connection for control functions
- 3 "relay" connection with relay contacts
- 4 "RS 485" connection as a serial interface
- 5 Ground terminal
- 6 Mains power supply
- 7 USB connection (type B)
- 8 Ethernet interface

4.4 Display elements



Display text in this manual

Both lines of the display text are separated in this manual by a vertical dash (**Line 1** | **Line 2**).

Display elements of the device

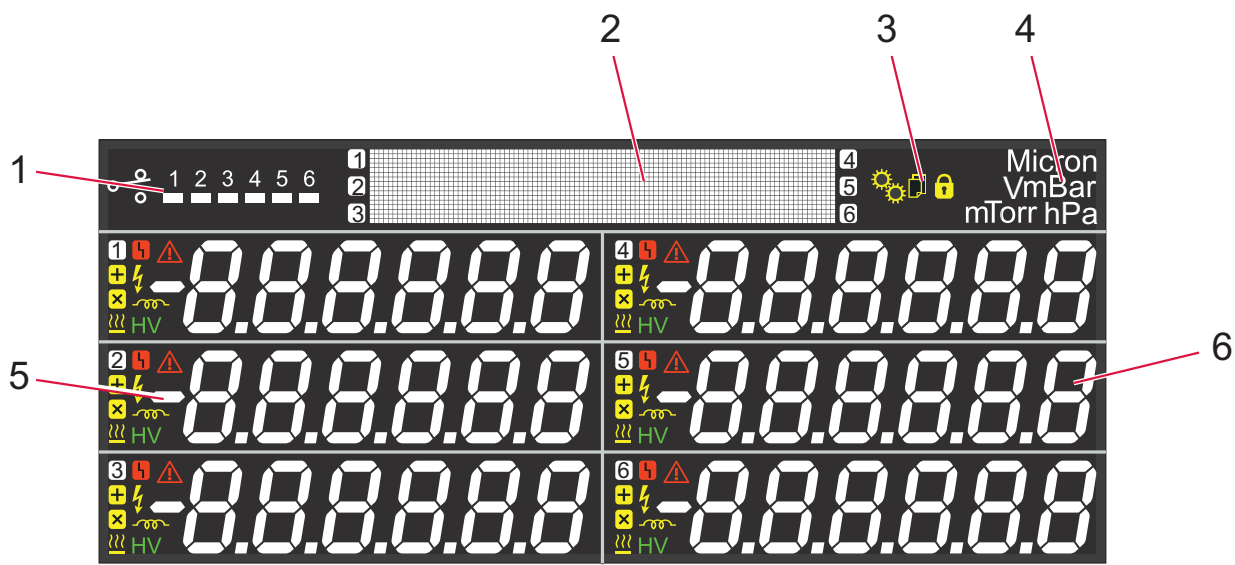

Fig. 4: Display

- | | | | |
|---|------------------------------|---|--|
| 1 | Switch-points | 4 | Unit of pressure or voltage |
| 2 | Parameter or bar graph | 5 | Measurement channel status (measurement channel 1-3) |
| 3 | Parameter mode or input lock | 6 | Measurement channel status (measurement channel 4-6) |

Parameter or bar graph

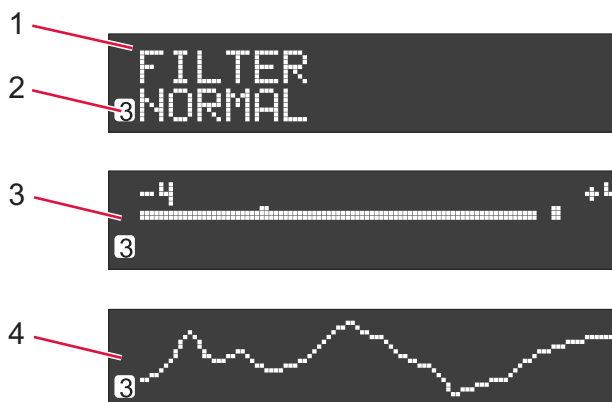

Fig. 5: Parameter or bar graph

- | | | | |
|---|-----------------------------------|---|---|
| 1 | Parameter display (2 lines) | 3 | Bar graph with switch-point for measurement channel 3 |
| 2 | Display for measurement channel 3 | 4 | Pressure vs. time, trend for measurement channel 3 |

Switch-points, parameter mode and input lock



Fig. 6: Switch-points, parameter mode and input lock

- 1 Switch-points from relay 1 to 6
- 2 Parameter mode activated
- 3 Input lock activated
- 4 Relay 3 off
- 5 Relay 1 on

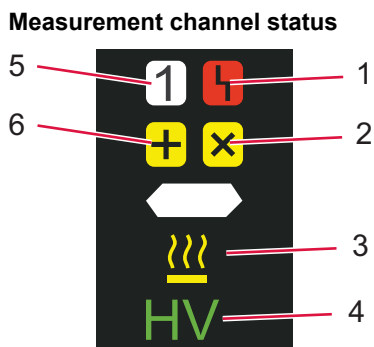

Fig. 7: Measurement channel status

- 1 Error
- 2 Calibration factor (COR)
- 3 Degas
- 4 High vacuum sensor
- 5 Measurement channel
- 6 Offset

4.5 Controls

Key	Designation	Functions (depending on operating mode)
	Parameter	<ul style="list-style-type: none"> • Change to parameter mode • Select parameter/group • Confirm selection • Save changes and return to read mode
	Measurement channel	Change measurement channel
	UP and DOWN arrow keys	<ul style="list-style-type: none"> • Select parameter • Press for < 1 second: Increase/reduce/change value by increments • Press for > 1 second: Increase/reduce/change value continually

Tbl. 5: Controls

4.6 Interfaces

4.6.1 Mains power supply

⚠ DANGER

Risk to life due to electric shock

An improperly earthed unit is a potential threat to life in the event of a fault.

- ▶ Conduct the electrical connection in accordance with locally applicable regulations.
- ▶ Make sure that the local mains voltage and frequency match rating plate specifications.
- ▶ Use only a 3-pin mains cable and extension cables with properly connected protective earthing (earthed conductor).
- ▶ Plug the mains plug into a socket with earthing contact only.
 - Protection must not be impaired by an extension with no earthed conductor.
- ▶ Always connect the mains cable prior to all other cables, to ensure continuous protective earthing.
 - In reverse: always disconnect all other cables prior to disconnecting the mains cable.

The mains connection with mains switch is located on the rear side of the device. A mains cable is included in the shipment. If the mains plug is not compatible with your system, you can use a separate, suitable mains cable with earthed conductor ($3 \times 1.5 \text{ mm}^2$). If you install the device in a control cabinet, we recommend that you supply the mains voltage via a switched mains distributor. **The socket requires a 10 A fuse_{max}.**

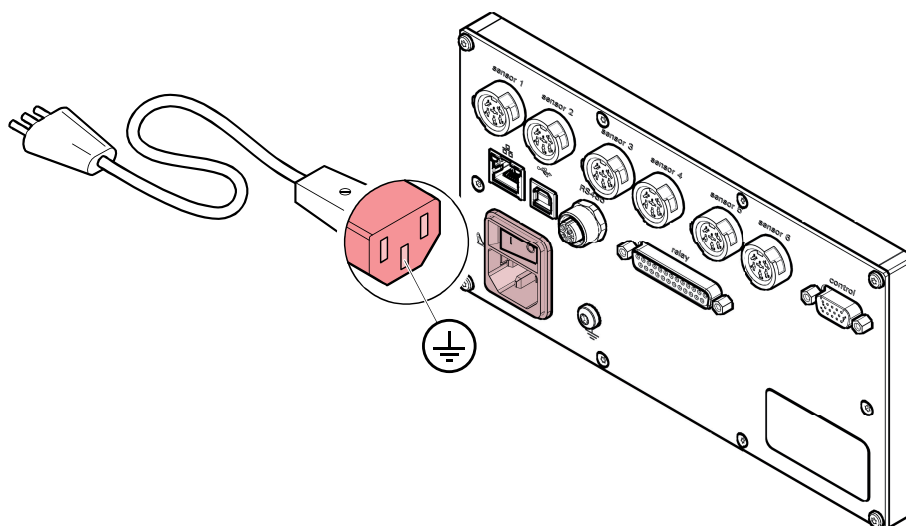

Fig. 8: Mains connection with IEC 320 C13 socket

4.6.2 Ground terminal

⚠ DANGER

Danger to life from electric shock

The internal earthed conductor is fastened to the housing by a screw. A device without an earthed conductor attached can be life-threatening in the event of a malfunction.

- ▶ Do not rotate or loosen the screw on the internal earthed conductor.

The connection to the protective earthing is located on the rear side of the device. Using the screw, you can connect the device where required via an earthed conductor to the protective earthing of the pumping station, for example.

4.6.3 "sensor" connection

⚠ DANGER

Danger to life due to dangerous contact voltage

Voltages above 30 V (AC) or 60 V (DC) are considered dangerous in accordance with EN 61010. If you come into contact with dangerous contact voltage, this can result in injury through electric shocks or even death.

► Only apply protected extra-low voltage (PELV).

A device socket is available for each measurement channel for connecting a gauge. You can connect the gauges using a preconfigured measurement cable or a self-assembled, shielded cable (EMC compatibility) at the "sensor" connection on the rear of the device. Please note the list of usable gauges.

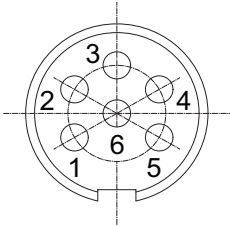

Fig. 9: Gauge connection (6-pin Amphenol C 091 B socket)

- | | |
|---|--------------------------------------|
| 1 Identification | 4 Analog mass (measurement signal -) |
| 2 Earth (GND) | 5 Screening, shielding |
| 3 Signal input (measuring signal 0 to +10 V DC) | 6 Supply voltage (+24 V DC) |

4.6.4 "control" connection

⚠ DANGER

Danger to life due to dangerous contact voltage

Voltages above 30 V (AC) or 60 V (DC) are considered dangerous in accordance with EN 61010. If you come into contact with dangerous contact voltage, this can result in injury through electric shocks or even death.

► Only apply protected extra-low voltage (PELV).

This connection can be used to read the measurement signal, check the status of the malfunction monitoring system, and switch the gauges on and off. A suitable cable plug is included in the device shipment. You can connect the peripheral components with a self-assembled, screened cable (EMC compatibility) to the connection on the rear side of the device.

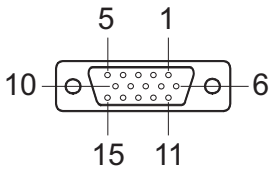

Fig. 10: "control" connection (15-pole D-Sub socket)

- | | |
|--|---------------------------|
| 1 Analog output gauge 1 0 – +10 V (DC) | 11 Control output gauge 2 |
| 2 Analog output gauge 2 0 – +10 V (DC) | 12 Control output gauge 3 |
| 3 Analog output gauge 3 0 – +10 V (DC) | 13 Control output gauge 4 |
| 4 Analog output gauge 4 0 – +10 V (DC) | 14 Control output gauge 5 |
| 5 Analog output gauge 5 0 – +10 V (DC) | 15 Control output gauge 6 |
| 6 Analog output gauge 6 0 – +10 V (DC) | 7, 8, 9 GND |
| 10 Control output gauge 1 | |

4.6.5 "relay" connection

⚠ DANGER

Danger to life due to dangerous contact voltage

Voltages above 30 V (AC) or 60 V (DC) are considered dangerous in accordance with EN 61010. If you come into contact with dangerous contact voltage, this can result in injury through electric shocks or even death.

- ▶ Only apply protected extra-low voltage (PELV).

You can use this connection to use the zero-potential (floating) state of the switching functions for external control. You can connect the peripheral components with a self-assembled, screened cable (EMC compatibility) to the connection on the rear side of the device.

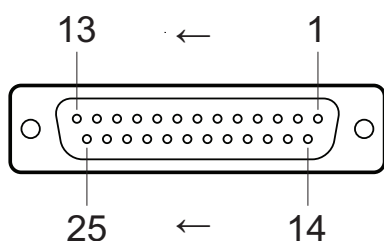

Fig. 11: "relay" connection (25-pole D-Sub socket)

1, 7	Earth (GND)	16, 17, 18	Switching function 4
25	+24 V (DC), 200 mA ¹⁾	19, 20, 21	Switching function 5
4, 5, 6	Switching function 1	22, 23, 24	Switching function 6
8, 9, 10	Switching function 2	3, 14, 15	Error signal (error)
11, 12, 13	Switching function 3	2	unassigned

Pins	Switching function	Description	Switching function	Description
4 8 11 16 19 22		Pressure higher than threshold value or device switched off		Pressure lower than threshold value
5 9 12 17 20 23				
6 10 13 18 21 24				
3		Error or device switched off		No errors
15				
14				

Tbl. 6: Switching functions

4.6.6 Connection "RS-485"

The "RS-485" connection enables control of the device using a computer or terminal. The use of a Y-distributor permits the integration into a bus system. You can connect the serial interface with a shielded cable (EMC compatibility) to the "RS-485" connection on the rear of the device.

If a virtual series interface (COM) is not automatically set up, you can download the driver from [FTDI Chip \(Virtual COM Port Drivers\)](#) and then install it.

1) Supply for relays with higher switching power. Fused at 200 mA with PTC element, self-resetting after switching off the device or after unplugging the "relay" plug. Meets the requirements of protected extra-low voltage (PELV).

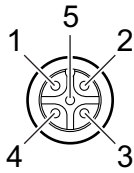

Fig. 12: "RS-485" connection (5-pole Binder M12 socket)

- | | |
|--------------------------|--------------------------|
| 1 RS-485+ (differential) | 4 RS-485+ (differential) |
| 2 +24 V (DC), ≤ 200 mA | 5 unassigned |
| 3 Earth (GND) | |

4.6.7 "USB" connection (type B)

The "USB" connection (type B) enables direct communication with the device via a computer (e.g. firmware updates, storing parameters (reading/writing)). You can connect the USB interface with a screened cable (EMC compatibility) to the connection on the rear side of the device.

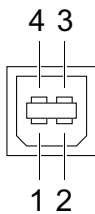

Fig. 13: "USB" connection (type B)

- | | |
|--------------|---------------|
| 1 VBUS (5 V) | 3 D+ |
| 2 D- | 4 Earth (GND) |

4.6.8 "USB" connection (type A)

The "USB" connection (type A) with master functionality is located on the front side and is used to connect a USB memory stick (e.g. firmware updates, storing parameters (reading/writing), data logger).

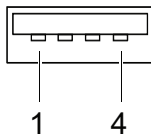

Fig. 14: "USB" connection (type A)

- | | |
|--------------|---------------|
| 1 VBUS (5 V) | 3 D+ |
| 2 D- | 4 Earth (GND) |

4.6.9 "Ethernet" (LAN) connection

The "Ethernet" connection enables direct communication with the device via a computer.

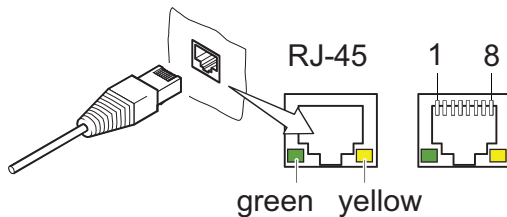

Fig. 15: "Ethernet" (LAN) connection

1	Transmission data (TD+)	6	Reception data (RD-)
2	Transmission data (TD-)	4, 5, 7, 8	Not used
3	Reception data (RD+)		

LED	Status	Meaning
Green (link)	lights up	Hardware connection exists
	dark	No hardware connection
Yellow (activity)	lit up (flickering)	Data transmission runs
	dark	no data transmission / no connection

Tbl. 7: Status of the Ethernet connection

5 Installation

5.1 Installing the device in a 19" rack

NOTICE

Damage caused by overheating

The ambient temperature must not exceed the permissible operating temperature of the device.

- ▶ Make sure there is unobstructed circulation of air when installing the device.
- ▶ Make sure that air can enter and exit through the ventilation openings without obstruction.
- ▶ Do not cover the ventilation openings.
- ▶ Periodically check and clean the installed air filter.

NOTICE

Loss of control cabinet protection class

As a built-in unit, the device can negate the required protection class (protection against foreign matter and water) of control cabinets according to EN 60204-1, for example.

- ▶ Take suitable measures to reestablish the required protection class.

You can insert the device in a 19" rack module adapter as per DIN 41 494. For this purpose, 4 collar screws and synthetic nipples are included in the shipment.

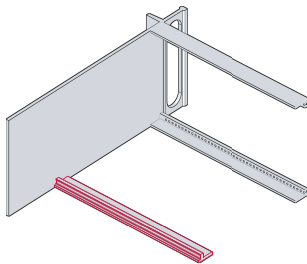

Fig. 16: Guide rails

Installing guide rails

- ▶ Install guide rails on the rack module adapter.
 - This is used for load relieving on the front panel of the device.

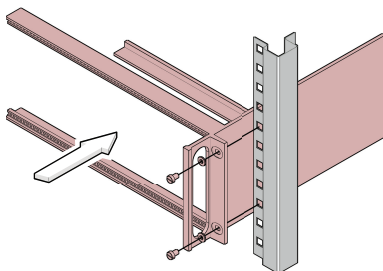

Fig. 17: Rack module adapter (3 height units)

Fastening the rack module adapter

- ▶ Fasten the rack module adapter in the rack cabinet.

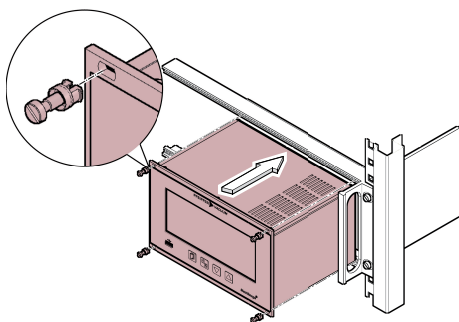

Fig. 18: Device installation

Installing the device in the rack module adapter

Required tools

- Screwdriver

Required material

- 4 × collar screws and synthetic nipple
 - Slide rails (optional)
1. Recommendation: Install the slide rails in the rack frame for safe and easy installation of heavy rack module adapters.
 2. Push the device into the rack module adapter.
 3. Fasten the device using the screws included in the shipment.

5.2 Installing the device in a switchboard

NOTICE

Damage caused by overheating

The ambient temperature must not exceed the permissible operating temperature of the device.

- ▶ Make sure there is unobstructed circulation of air when installing the device.
- ▶ Make sure that air can enter and exit through the ventilation openings without obstruction.
- ▶ Do not cover the ventilation openings.
- ▶ Periodically check and clean the installed air filter.

NOTICE

Loss of control cabinet protection class

As a built-in unit, the device can negate the required protection class (protection against foreign matter and water) of control cabinets according to EN 60204-1, for example.

- ▶ Take suitable measures to reestablish the required protection class.

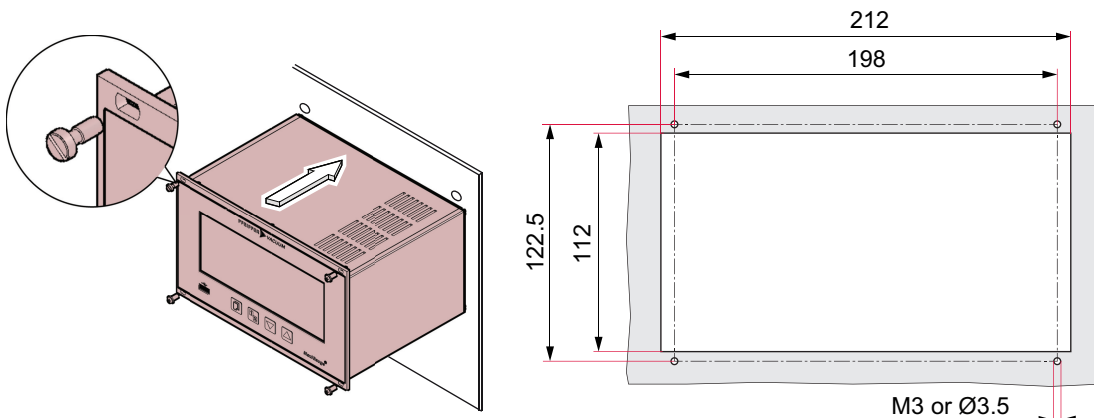

Fig. 19: Required control panel cut-out

Installing the device in a switchboard

Required tools

- Screwdriver

Required material

- 4 screws (M3 or equivalent)
1. Support the device from below to relieve the front panel.
 2. Push the device into the control panel cut-out.
 3. Support the device to relieve the front panel.
 4. Fasten the device using 4 screws.

5.3 Using the device as a desktop device

NOTICE
<p>Damage caused by overheating</p> <p>The ambient temperature must not exceed the permissible operating temperature of the device.</p> <ul style="list-style-type: none"> ▶ Make sure there is unobstructed circulation of air when installing the device. ▶ Make sure that air can enter and exit through the ventilation openings without obstruction. ▶ Do not cover the ventilation openings. ▶ Periodically check and clean the installed air filter.

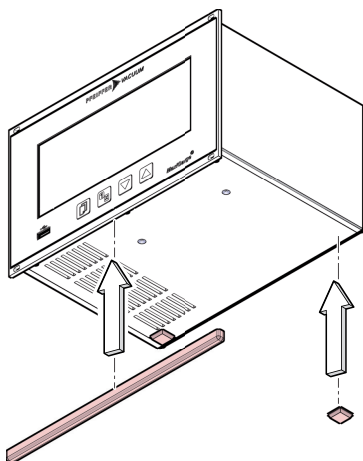

Fig. 20: Fastening the rubber feet and rubber strip

Using the device as a desktop device

You can use the device as a desktop device. The shipment includes two self-adhesive rubber feet as well as an attachable rubber strip, for this purpose.

Required material

- 2 self-adhesive rubber feet
 - 1 attachable rubber strip
1. Stick the 2 rubber feet at the rear side on the housing base.
 2. Stick the rubber strip on the front panel from underneath.

6 Commissioning

6.1 Switch on the device

Prerequisites

- You have installed the device correctly.
- You have adhered to the technical data.
- ▶ Switch on the device at the mains switch.
- ▶ **For rack assembly:** Switch on the device centrally via the switched mains distributor.

After switching on:

- The device performs a self test.
- The device identifies the connected gauges.
- The device activates the parameters that were in place on last switching off.
- The device switches to measuring mode.
- The device adjusts the parameters if necessary, if another gauge was connected previously.

6.2 Updating the firmware

If your device requires a more recent firmware version, in order to support new gauges for example, please contact your nearest Pfeiffer Vacuum Service Center.

A firmware update can be performed

- using a USB memory stick (USB type A on the front side of the device) or
- using the USB Update Tool via the USB type B connection on the rear side of the device.



USB memory sticks

The device does not recognize all USB memory sticks, for instance if they do not comply with the USB standard. Try using a different memory stick first before you contact your nearest Pfeiffer Vacuum Service Center.

The settings you changed in parameter mode are usually also available after performing a firmware update. However, we recommend that you store the parameters before performing an update (set-up mode).

Updating via a USB memory stick is an automatic process with the following steps:

1. **BOOTING**
 - very short
2. **BOOTLOADER V1.x**
 - very short
3. **ERASING FW...**
 - Old firmware is deleted from the device.
4. **UPDATING FW...**
 - New firmware is written to the device.
5. **UPDATE COMPLETE**
 - Update is done.

Updating the firmware with a USB memory stick (USB type A)

1. Open the Pfeiffer Vacuum [Download Center](#) in the browser.
2. Enter the name of your device as the keyword.
3. Select "Software".
 - The display lists the available documents and software.
4. Download the ZIP file in the desired language.
 - The ZIP file contains the files with file extension ".S19" and ".CNF".
5. Unzip both files.
6. Save both files on the USB memory stick.
7. Turn off the device.
8. Plug the USB memory stick into the device.
9. Turn on the device.

- The update takes place automatically.
- 10. Remove the USB memory stick from the device.
 - The device automatically restarts.
- 11. If required, write the customer-specific settings that were stored before the update back to the device.

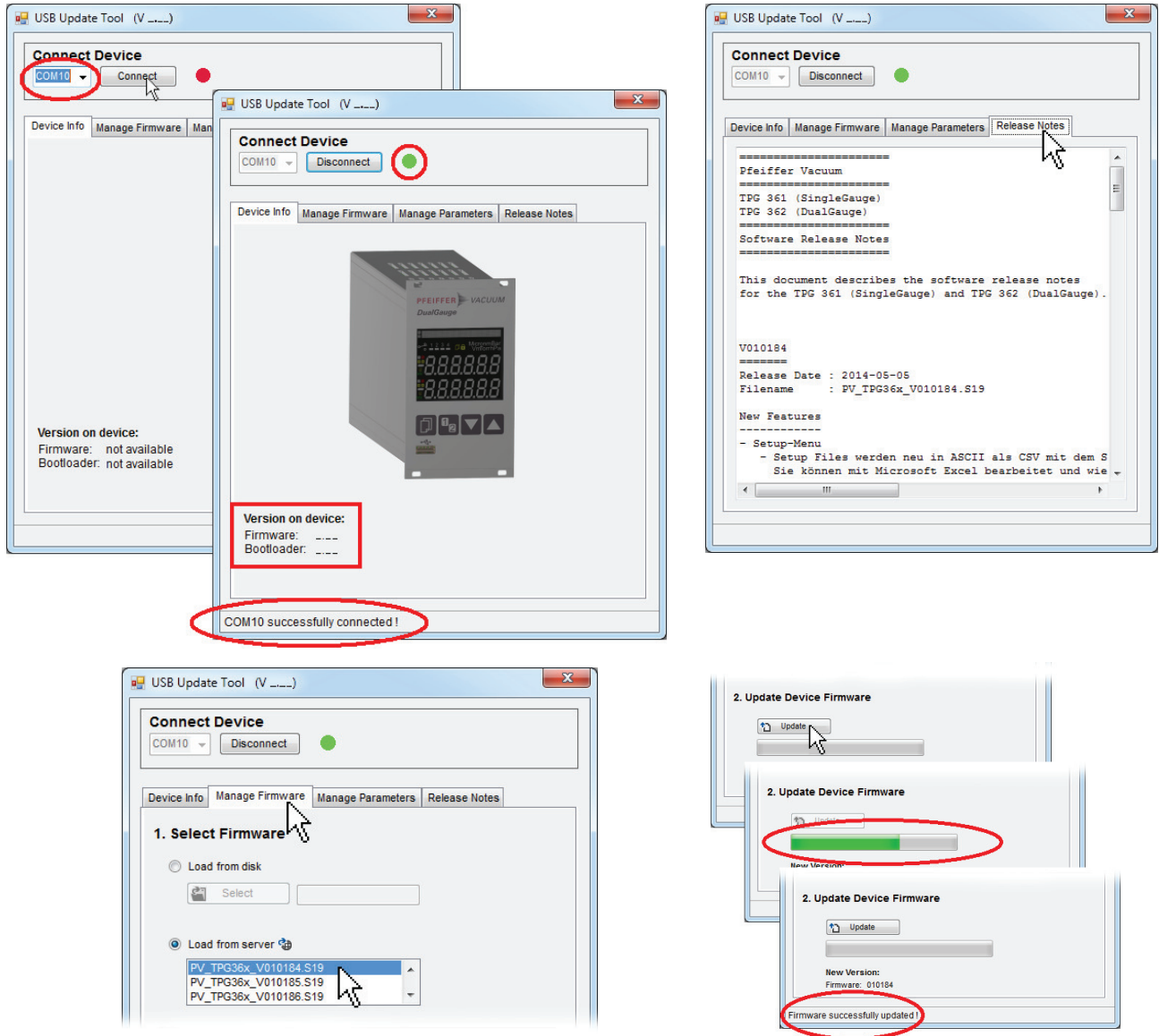

Fig. 21: USB Update Tool

Updating the firmware with the USB Update Tool (USB type B)

If a virtual series interface (COM) is not automatically set up, you can download the driver from [FTDI Chip \(Virtual COM Port Drivers\)](#) and then install it.

Prerequisites

- You must use the Windows XP, 7, 8 or 10 operating system.
 - Make sure there is no USB memory stick connected to the front side of the device.
1. Open the Pfeiffer Vacuum [Download Center](#) in the browser.
 2. Enter "USB Update Tool" as the keyword.
 - The display lists the available software.
 3. Download the file in the desired language.
 4. Connect the device to the PC using a USB cable (type A/B).
 5. Start the USB Update Tool.
 6. Select the COM interface from the selection list.
 7. Click on "Connect".

8. Go to the "Release Notes" tab.
 - You will find the change log here.
9. Go to the "Manage Parameters" tab.
 - We recommend that you store the parameters here before performing an update.
10. Go to the "Manage Firmware" tab.
11. Select the firmware.
 - <Load from disk> (local file) or <Load from server> (server connection).
12. Click on "Update".
 - After the update, the status message "Firmware successfully updated!" appears at the bottom edge of the window.
13. If the update was not successful, repeat the procedure.
14. Go to the "Manage Parameters" tab.
15. Write the parameters back to the device.

6.3 Configuring Ethernet

You can use the device to establish a connection via the virtual COM interface or via Winsock/Telnet.

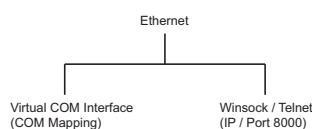

COM mapping

The Ethernet Configuration Tool enables the configuration of the Ethernet interface using a PC. Additionally, you can assign a virtual series interface (COM) to an IP address. You can access the virtual COM interfaces using every program that supports series interfaces (e.g. terminal program, LabView, etc.). Depending on the protocol setting, communication with the device is either via the Mnemonic or Pfeiffer Vacuum protocol.

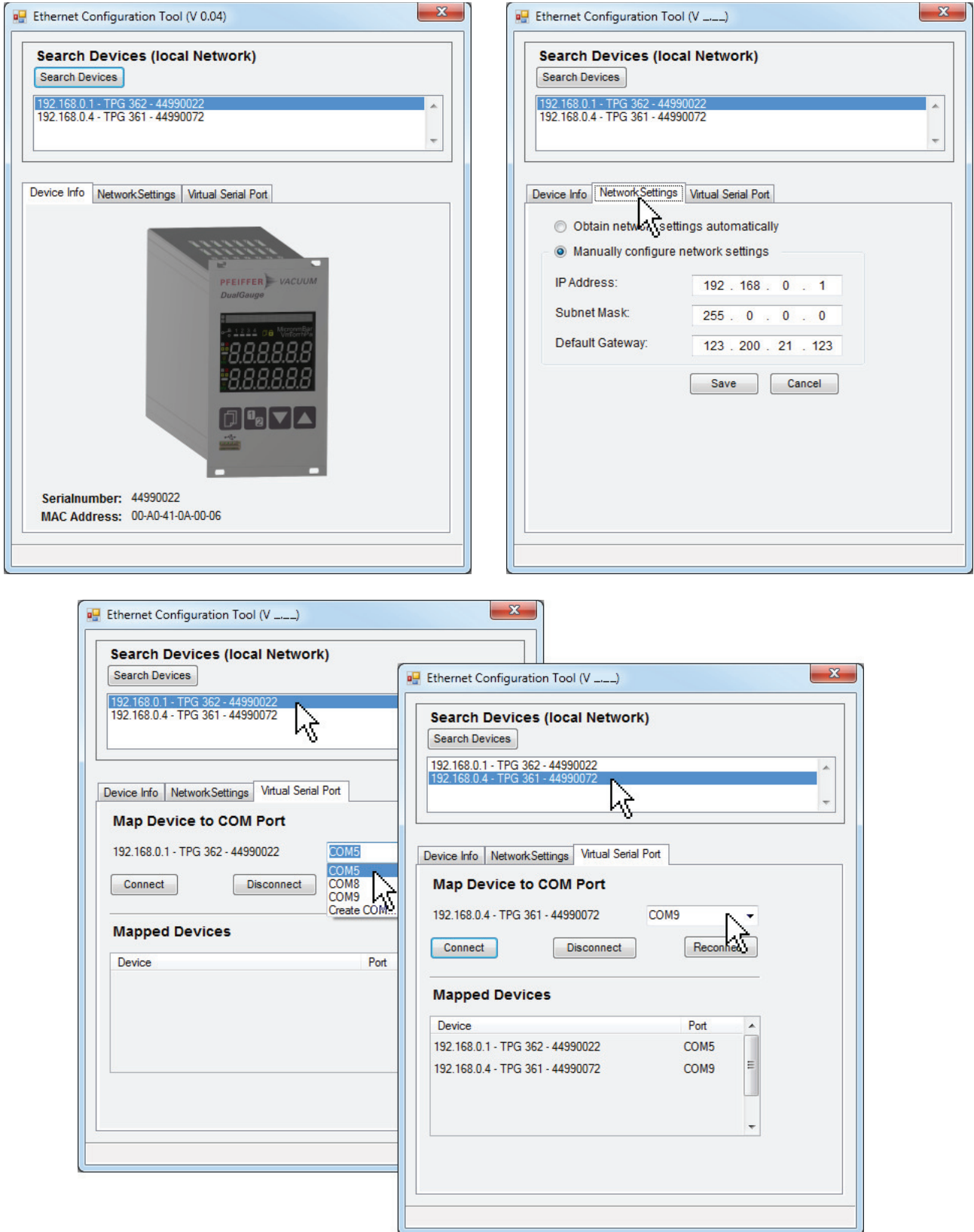

Fig. 22: Ethernet Configuration Tool

Ethernet Configuration Tool

- The "Device Info" tab displays basic information about the selected device.
- The automatic or manual network setting is made in the "Network Settings" tab.
- In the "Virtual Serial Port" tab, you can assign a separate COM port to each device and/or generate a new COM port.

Using the Ethernet Configuration Tool



Prerequisite

- You must use the Windows 7, 8 or 10 operating system.
 1. Recommendation: Contact your network administrator before you start the configuration.
 2. Recommendation: Update the operating system before you start the Ethernet configuration. You also require administrator rights.
 3. Open the Pfeiffer Vacuum [Download Center](#) in the browser.
 4. Enter "Ethernet Configuration Tool" as the keyword.
 - The display lists the available software.
 5. Download the file in the desired language.
 6. Connect the device to the network using an Ethernet cable.
 7. Start the Ethernet Configuration Tool.
 8. Click on "Search Devices".
 - The tool searches for connected devices on the local network and lists the devices it finds in the selection window.
 9. Make the required settings in the program.

7 Operation

7.1 Basic operation

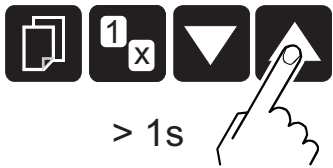
The following section provides information about the most important basic operations for the individual modes.

Operation	Description
	Press button
	Press button for longer than one second
	Do not press button
	Press buttons simultaneously

Tbl. 8: Description of the controls

7.2 Operating modes

The device operates in the following modes:

- **Measuring mode**
 - Display of measured value or status
- **Parameter mode**
 - Display and input of parameters:
 - Switching function parameter (**SWITCH-POINT**)
 - Gauge parameter (**SENSOR**)
 - Gauge control (**SENSOR CONTROL**)
 - General parameters (**GENERAL**)
 - Test program (**TEST**)
- **Data logger mode**
 - Recording of measured data (**DATA LOGGER**)
- **Setup mode**
 - Saving (reading/writing) parameters (**SETUP**)

7.3 Measuring mode

Measuring mode is the standard operations mode for the device:

- Displaying a bar graph (where required)

- Displaying a measured value per measurement channel
- Displaying status messages per measurement channel

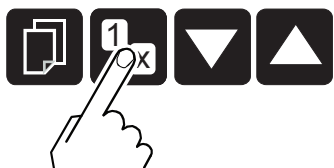

Fig. 23: Change measurement channel

Change measurement channel

You can use the "Measurement channel" button to switch between measurement channels. The number of the selected measurement channel lights up.

- ▶ Press the "Measurement channel" button until the number of the desired measurement channel is displayed.



Fig. 24: Switching gauges on and off

Switching gauges on and off

You can switch IKR, PKR, (MPT 200 AR), IMR and PBR (HPT 200 AR) gauges on and off manually, provided that you have set the gauge control to "SENSOR ON | HAND".

Instead of a measured value, a status message may be returned after switching OFF and switching on.

1. Press the "UP" arrow key for longer than 1 second in order to switch on the gauge.
2. Press the "DOWN" arrow key for longer than 1 second in order to switch off the gauge.

Measuring range

During operation with linear gauges (CTR, CCR), negative pressure values can be displayed.

Possible causes are:

- Negative drift
- Activated offset correction

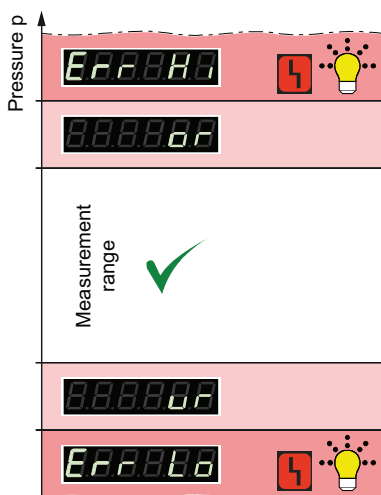

Fig. 25: Measuring range



Fig. 26: Identifying the gauge

Identifying the gauge

- ▶ Hold down both arrow keys for longer than 1 second.

The device reads the gauge identification (line 1) and the measuring point name (line 2, standard = empty) for the current measurement channel and displays this for 5 seconds, for example:

- PKR gauge connected (line 1): **PKR**
- No gauge connected (line 1): **NO SENSOR**
- Gauge connected but not identifiable (line 1): **NO IDENT.**

7.4 Parameter mode

Parameter mode is the operations mode for displaying and changing/entering parameter values, testing the device and saving measured data. Parameter groups exist for better structuring.



Fig. 27: Change from measuring mode to parameter mode

Parameter groups

- Switching function parameters
- Gauge parameters
- Gauge control
- General parameters
- Test parameters

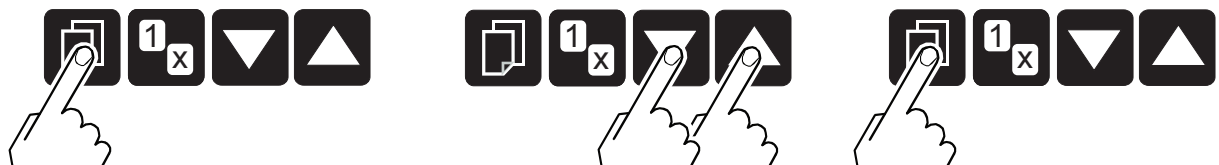

Fig. 28: Select parameter group

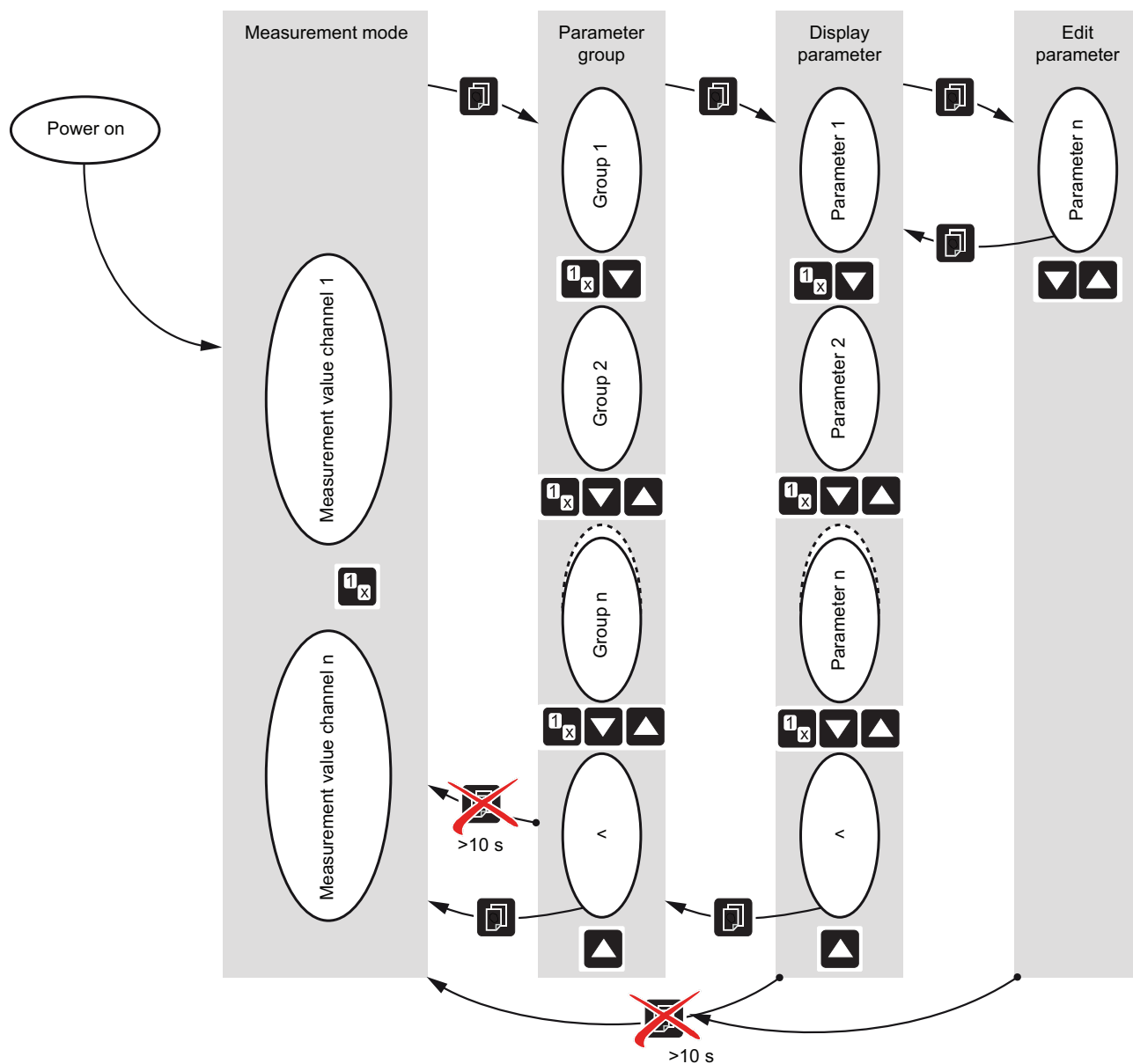

Fig. 29: Read/write parameter groups and parameters

Change parameters

1. Press the "Parameter" button to switch to parameter mode.
 - The display shows the respective parameter group instead of the bar graph. The symbol for Parameter mode lights up.
2. Press the "UP" and "DOWN" arrow buttons to select a parameter group.
3. Press the "Parameter" button to confirm the parameter group.
4. Read the parameters of the selected parameter group using the "UP" and "DOWN" arrow buttons.
5. Press the "Parameter" button to confirm the desired parameter.
 - The value flashes and you can now change it.
6. Use the "UP" and "DOWN" arrow buttons to change the value.
7. Press the "Parameter" button to save the change.
 - You then return to read mode.

7.4.1 Switching function parameters

Parameter	Description
Switch-point n S	Assignment of switch-point n to a measurement channel
Switch-point n L	Switch-point n: Lower threshold value (LOW)
Switch-point n H	Switch-point n: Upper threshold value (HIGH)

Tbl. 9: Switching function parameters

The switching function parameters group includes displaying and editing/inputting threshold values and assigning switching functions to a measurement channel. The lower and upper threshold value of a switching function always belong to the same channel. The last assignment to be carried out applies for both threshold values.

The device has six switching functions, each with two adjustable threshold values. The states of the switching functions are shown on the display and are available as zero-potential contacts at the "relay" connection.

The lower threshold value (setpoint low) defines the pressure at which the switching function is switched on if the pressure drops. The upper switching function (setpoint high) defines the pressure at which the switching function is switched off if the pressure rises.

	<p>Setting the threshold values</p> <p>Pfeiffer Vacuum recommends setting the upper threshold value 1/2 decade above the lower threshold value or the lower threshold value 1/2 decade below the upper threshold value.</p>
---	--

Display	Description
SWITCH-POINT 1 S SENSOR 1	Switching function 1 is assigned to channel 1.
SWITCH-POINT 1 S SENSOR 2	Switching function 1 is assigned to channel 2.
SWITCH-POINT 1 S OFF	Switching function 1 is switched off (factory setting).
SWITCH-POINT 1 S ON	Switching function 1 is always switched on.
SWITCH-POINT 1 L 5.00-4	Limit of the lower threshold value (gauge-dependent) If the gauge type changes, the device automatically adjusts the threshold value if necessary.
SWITCH-POINT 1 H 1500	Limit of upper threshold value (gauge-dependent) If the gauge type changes, the device automatically adjusts the threshold value if necessary.

Tbl. 10: Examples of switching function displays

Gauge type	Lower threshold value [hPa]	Minimum hysteresis	Upper threshold value [hPa]
TPR/PCR (PPT 200 AR / RPT 200 AR)	$5 \cdot 10^{-4}$ 2)	+10% lower threshold value	1500
IKR 2x1	$1 \cdot 10^{-9}$		$1 \cdot 10^{-2}$
IKR 36x			
IKR 270	$1 \cdot 10^{-11}$		
PKR (MPT 200 AR)	$1 \cdot 10^{-9}$		1000
IMR	$1 \cdot 10^{-6}$		1000
PBR (HPT 200 AR)	$5 \cdot 10^{-10}$	1000	
CMR/APR (CPT 200 AR)	F.S. / 1000	+1% measuring range (F.S.)	F.S.

Gas = nitrogen

Tbl. 11: Upper and lower threshold values



Minimum hysteresis

The minimum hysteresis between the upper and lower threshold value is a minimum of 10% of the lower threshold value (logarithmic gauges) or 1% of the set upper range value (linear gauges). The upper threshold value is automatically updated with minimum hysteresis if required. This prevents an unstable state.

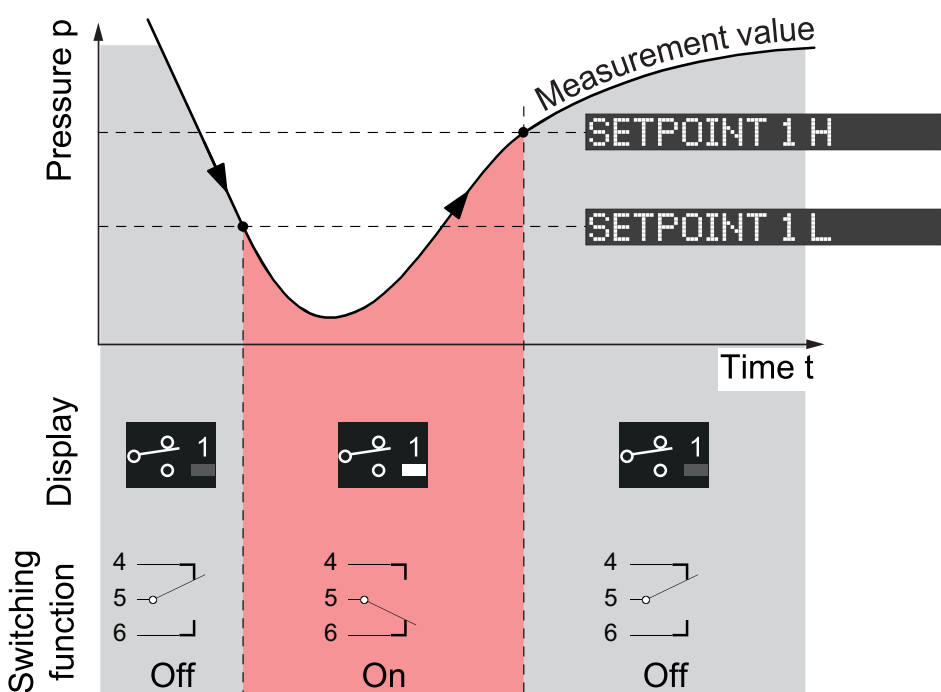

Fig. 30: Switching functions and threshold values

2) $5 \cdot 10^{-5}$ hPa with activated RNE-EXT

7.4.2 Gauge parameters

Parameter	Description
DEGAS FILAMENT	Clean electrode system
FULLSCALE	Measuring range of linear gauges
FILTER	Measured value filter
OFFSET	Offset correction
GAS	Calibration factor for other gas types
COR	Calibration factor
SPACES	Display resolution
NAME	Measuring point name

Tbl. 12: Gauge parameters

The gauge parameters group includes displaying and editing/inputting gauge-related parameters. Some parameters are not available for all gauges and are thus not always displayed.

Gauge type	TPR/PCR (PPT 200 AR / RPT 200 AR)	IKR	PKR (MPT 200 AR)	IMR	PBR (HPT 200 AR)	CMR/APR (CPT 200 AR)
DEGAS FILAMENT					X	
FULLSCALE						X
FILTER	X	X	X	X	X	X
OFFSET						X
GAS	X ³⁾	X	X ⁴⁾	X ⁵⁾	X ^{6) 7)}	
COR	X	X	X	X	X	X
SPACES	X	X	X	X	X	X
NAME	X	X	X	X	X	X

Tbl. 13: Available parameters (gauge parameters)

DEGAS FILAMENT

Deposits on the electrode system of hot ionization gauges can result in an unstable measured value. Degas ON enables cleaning of the electrode system by heating the electron collection grid to approx. 700 °C through electron bombardment for 180 seconds (can be switched off prematurely by pressing the "DOWN" arrow button). The "Degas" display is lit up during this time. In normal operation, degas is locked (OFF).

FULLSCALE

With linear gauges, you must define their upper range value (Full Scale); the device detects this automatically for logarithmic gauges.

FILTER

The measured value filter permits a better evaluation of measurement signals with fluctuation or interference. The measured value filter does not affect the analog output.

- OFF
 - No measured value filter
- RAPID

- 3) Effective as of a pressure < 1 hPa.
- 4) Effective as of a pressure < 1 · 10⁻⁵ hPa.
- 5) With restrictions
- 6) With restrictions
- 7) Effective as of a pressure < 1 · 10⁻² hPa.

- The device responds rapidly to measured value fluctuations and thus responds to measured value disturbances in an accordingly sensitive manner.
- NORMAL (factory setting)
 - Setting with good ratio between speed of response and sensitivity of display and switching function with respect to measured value changes.
- SLOW
 - The device does not respond to minor measured value fluctuations and thus responds more slowly to measured value changes. Pfeiffer Vacuum recommends this setting for precise comparison measurements.

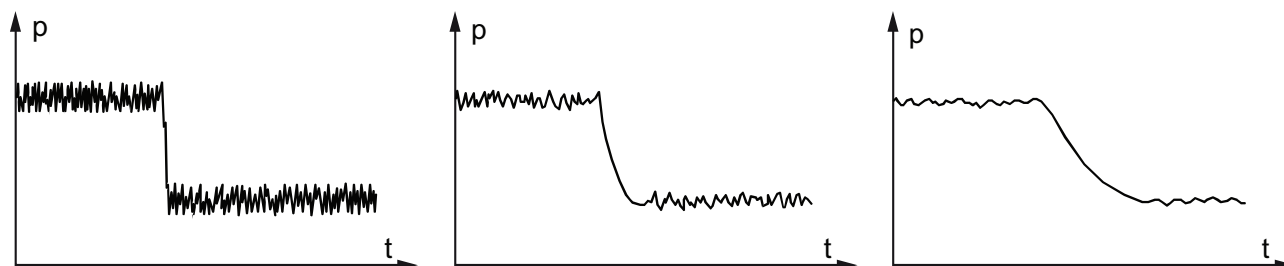

Fig. 31: Fast, normal and slow (from left to right)

OFFSET

Displays the offset value in the current unit of measure and recalibrates to the current measured value. Offset correction is switched off as the factory setting and affects the measured value display. Offset correction does not affect the threshold value display of the switching functions and the analog outputs at the “control” connection.

If offset correction is enabled, the display lights up and the stored offset value is subtracted from the current measured value. This enables relative measurements with regard to a reference pressure.



Resetting the zero point on the gauges

You must switch off offset correction before you reset the zero point on the gauges.

GAS

The calibration factor GAS permits

- the standardization of the measured value to the non-adjustable gas types nitrogen (N₂), Argon (Ar), Hydrogen (H₂), Helium (He), Neon (Ne), Krypton (Kr) and Xenon (Xe), or
- the manual input of the calibration factor for other gases (parameter COR).

This parameter is not available for the Volt unit of measure.

COR

The calibration factor COR is effective across the entire measuring range and permits the standardization of the measured value to other gas types by a factor of 0.10 to 10.00. A prerequisite is that the “GAS” parameter is set to “COR”. The display lights up when COR is switched on.

This parameter is not available for the Volt unit of measure.

SPACES

Resolution of the displayed measured value (decimal places). The factory setting is AUTO, which means that the number of places depends on the connected gauge and the current pressure value.

The display is in the pressure range $p < 1.0 \cdot 10$ for PCR gauges⁻⁴ hPa and reduces the activated range expansion by one decimal place.

NAME

Name of the measuring point with maximum 8 characters. Only capital letters, numbers and underscores are permitted.

7.4.3 Gauge control

Parameter	Description
SENSOR ON	Gauge switch-on type
SENSOR OFF	Gauge switch-off type
THRESHOLD VALUE ON	Switch-on threshold value
THRESHOLD VALUE OFF	Switch-off threshold value

Tbl. 14: Gauge control

The gauge control group includes displaying and editing/inputting parameters used to define how gauges are switched on and off. If only gauges without a control option connected, the group is not available.

Some parameters are not available for all gauges and are thus not always displayed.

Gauge type	TPR/PCR (PPT 200 AR / RPT 200 AR)	IKR	PKR (MPT 200 AR)	IMR	PBR (HPT 200 AR)	CMR/APR (CPT 200 AR)
SENSOR ON		X	X	X	X	
SENSOR OFF		X	X	X	X	
THRESHOLD VALUE ON		X		X	X	
THRESHOLD VALUE OFF		X		X	X	

Tbl. 15: Available parameters (gauge control)

SENSOR ON

You can switch on certain gauges using different switch-on types.

Adjustment, setting	Description
HAND	You can manually switch on the gauges by pressing the "UP" arrow button.
EXTERNAL	You can switch on the gauges via the corresponding control input at the "control" connection.
HOT START	The gauge switches on automatically when the device is switched on. This allows measuring to continue following a power failure.
S 1	The gauge on measurement channel 1 automatically switches the gauges on. ⁸⁾
S n	The gauge on measurement channel n automatically switches the gauges on. ⁹⁾

Tbl. 16: Switch-on type (SENSOR ON)

SENSOR OFF

You can switch off certain gauges using different switch-off types.

Adjustment, setting	Description
HAND	You can manually switch off the gauge by pressing the "DOWN" arrow button.
EXTERNAL	You can switch off the gauge via the corresponding control input at the "control" connection.
SELF ¹⁰⁾	Self-monitoring: The gauge switches off automatically in case of a pressure rise.

8) cannot be selected for PKR and MPT 200 AR

9) cannot be selected for PKR and MPT 200 AR

10) Additionally for IKR gauges only

Adjustment, setting	Description
S 1	The gauge on measurement channel 1 automatically switches the gauges off. ¹¹⁾
S n	The gauge on measurement channel n automatically switches the gauges off. ¹²⁾

Tbl. 17: Switch-off type (SENSOR OFF)

THRESHOLD VALUE ON

Definition of the switch-on threshold value when using the gauge on the other channel to switch on. The value for THRESHOLD VALUE OFF must be \geq THRESHOLD VALUE ON.

THRESHOLD VALUE OFF

Definition of the switch-off threshold value when using the gauge on another channel to switch off, or for self-monitoring. The value for THRESHOLD VALUE OFF must be \geq THRESHOLD VALUE ON.

Gauge type	TPR/PCR (PPT 200 AR / RPT 200 AR)	PKR/IMR/PBR (MPT 200 AR / HPT 200 AR)	CMR/APR (CPT 200 AR)		
			F.S. = 1	F.S. = 10	F.S. = 100
IKR	10^{-3} Up to 10^{-2} ¹³⁾	10^{-5} Up to 10^{-2}	$10^{-3} - 10^{-2}$	-	-
IMR	10^{-3} Up to 1 ¹⁴⁾	10^{-5} Up to 1	$10^{-3} - 1$	$10^{-2} - 1$	$10^{-1} - 1$
PBR (HPT 200 AR)	10^{-3} Up to 1 ¹⁵⁾	10^{-5} Up to 1	$10^{-3} - 1$	$10^{-2} - 1$	$10^{-1} - 1$

all values in hPa, CAL = 1

Tbl. 18: Switch on/off thresholds

7.4.4 General parameters

Parameter	Description
UNIT	Unit of measure
BAUD RATE USB	Baud rate of the USB interface
RANGE EXT	Pirani range extension
ERROR RELAY	Error relay
PENNING-UR	Penning underrange
BARGRAPH / GRAPH	Display in bar graph
RS485 ADDRESS	RS-485 device address
PROTOCOL	Serial interface protocol
BACKLIGHT	Background lighting
SCREENSAVER	Screensaver
CONTRAST LCD	Contrast setting
STANDARD CHARGING	Factory settings
LANGUAGE	Language
FORMAT	Number format of the measured value

11) cannot be selected for PKR and MPT 200 AR

12) cannot be selected for PKR and MPT 200 AR

13) 10^{-4} hPa if range extension is enabled

14) 10^{-4} hPa if range extension is enabled

15) 10^{-4} hPa if range extension is enabled

Parameter	Description
END VALUE	Representation of the upper range value
DHCP (ETH)	Dynamic Host Configuration Protocol (Ethernet)
IP (ETH)	IP Address (Ethernet)
SUBNET (ETH)	Subnet mask (Ethernet)
GATEWAY (ETH)	Gateway address (Ethernet)

Tbl. 19: General parameters

The general parameters group includes displaying and editing/inputting generally-applicable parameters (system parameters).

Gauge type	TPR/PCR (PPT 200 AR / RPT 200 AR)	IKR	PKR (MPT 200 AR)	IMR	PBR (HPT 200 AR)	CMR/APR (CPT 200 AR)
UNIT	X	X	X	X	X	X
BAUD RATE USB	X	X	X	X	X	X
RANGE EXT	X					
ERROR RELAY	X	X	X	X	X	X
PENNING-UR		X				
BARGRAPH / GRAPH	X	X	X	X	X	X
RS485 ADDRESS	X	X	X	X	X	X
PROTOCOL	X	X	X	X	X	X
BACKLIGHT	X	X	X	X	X	X
SCREENSAVER	X	X	X	X	X	X
CONTRAST LCD	X	X	X	X	X	X
STANDARD CHARGING	X	X	X	X	X	X
LANGUAGE	X	X	X	X	X	X
FORMAT	X	X	X	X	X	X
END VALUE	X	X	X	X	X	X
DHCP (ETH)	X	X	X	X	X	X
IP (ETH)	X	X	X	X	X	X
SUBNET (ETH)	X	X	X	X	X	X
GATEWAY (ETH)	X	X	X	X	X	X

Tbl. 20: Available parameters (general parameters)

UNIT

The unit of measure for the measured values, threshold values etc.

- mbar
- hPa (factory setting)
- Torr (only available if the Torr lock is not activated.)
- Pa
- Micron (= 0.001 Torr) (only available if the Torr lock is not activated.)
- Volt

BAUD RATE USB

Transfer rate of the USB interface. The transmission rate of the RS-485 interface is 9600 baud; this cannot be changed.

- 9600 (factory setting), 19200, 38400, 57600 or 115200 baud

RANGE EXT

For TPR and PCR gauges with display/measuring range up to $5 \cdot 10^{-5}$ hPa, you can expand the display and switch-point setting area (only acts on the controller). This function is disabled as the factory setting.

- Display and switch-point setting range up to $5 \cdot 10^{-5}$ hPa

ERROR RELAY

The switching behavior of the error relay.

- ALL ERRORS
 - Switches with all errors (factory setting)
- no SENSOR ERRORS
 - Only device error
- SENSOR n ERROR
 - Error sensor n and device error

PENNING-UR**NOTICE****Unintentional results with controller connected**

Switch relay not dependent on pressure. Values below the intended measuring range, or starting the test program, can result in unintentional results at the connected controller, if the relay switches.

- ▶ Unplug the connected measuring and control cable.
- ▶ Prevent triggering of incorrect control commands or messages.

Definition of behavior if the value drops below the measuring range for cold cathode gauges (Penning underrange control).

Various causes can lead to underrange values:

- The pressure in the vacuum system is below the measuring range.
- The measuring element has (not) yet ignited.
- Discharge has stopped.
- A defect has occurred.
- OFF
 - If the function is switched off (factory setting), an underrange measurement is interpreted as a permissible measured value. UR is displayed. The switching function remains ON.
 - If the pressure in the vacuum system can drop below the measuring range of the gauge, selecting the "PENNING-UR OFF" option makes sense.
- ON
 - If the function is switched off, an underrange measurement is interpreted as an impermissible measured value. UR is displayed. The switching function changes to OFF.
 - For a setting of "PENNING-UR ON" the evaluation of the switching function is suppressed for 10 seconds after switching on the gauge and after returning from a measurement underrange case. The switching function remains OFF for this time.

BARGRAPH / GRAPH

A bar graph or the measured pressure as a function of time ($p = f_{(t)}$) can be shown on the display. During parameter setting, the parameter and the parameter value are displayed here.

- OFF
 - Disabled (factory setting)
- FULLSCALE
 - Bar graph over entire measuring range of gauge
- FULLSCALE h
 - Bar graph over entire measuring range of gauge, high representation
- FULLSCALE+SP
 - over entire measuring range of gauge and switch-point threshold value
- DECADE
 - Bar graph over one decade in accordance with current measured value
- DECADE h

- Bar graph over one decade in accordance with current measured value, high representation
- DECADE+SP
 - Bar graph over one decade in accordance with current measured value and switch-point threshold value
- f(0.2s)
 - $p = f_{(t)}$, auto-scaled, 0.2 seconds/pixel
 - The device stores a measured value in tabular form every 200 ms for each measurement channel, and shows the last 100 measured values (= 100 pixel) auto-sized. The illustrated data series corresponds with a recording duration of 20 seconds.
- f(1s)
 - $p = f_{(t)}$, auto-scaled, 1 second/pixel
 - The device stores a measured value in tabular form every second for each measurement channel, and shows the last 100 measured values (= 100 pixel) auto-sized. The illustrated data series corresponds with a recording duration of 100 seconds.
- f(6s)
 - $p = f_{(t)}$, auto-scaled, 6 seconds/pixel
 - The device stores a measured value in tabular form every 6 seconds for each measurement channel, and shows the last 100 measured values (= 100 pixel) auto-sized. The illustrated data series is equivalent to a recording duration of 10 minutes.
- f(1min)
 - $p = f_{(t)}$, auto-scaled, 1 minute/pixel
 - The device stores a measured value in tabular form every minute for each measurement channel, and shows the last 100 measured values (= 100 pixel) auto-sized. The illustrated data series is equivalent to a recording duration of 100 minutes.
- f(0.5h)
 - $p = f_{(t)}$, auto-scaled, 30 minutes/pixel
 - The device stores a measured value in tabular form every 30 minutes for each measurement channel, and shows the last 100 measured values (= 100 pixel) auto-sized. The illustrated data series is equivalent to a recording duration of 50 hours.
- IDENTIFICATION
 - The sensor type (line 1) and the measuring point name (line 2) are displayed for the selected measurement channel.
- SWITCH-POINTS
 - The sensor type (line 1) and the assigned switch-points (line 2) are displayed for the selected measurement channel.

RS485 ADDRESS

The address of the RS-485 device.

- Adjustable from 1 – 24 (factory setting = 1)

PROTOCOL

The protocol for the serial interface (RS-485, USB-B, Ethernet).

- AUTOMATIC (automatic detection (factory setting))
- PFEIFFER VACUUM (Pfeiffer Vacuum protocol)
- MNEMONIC 3 CHAR (Mnemonics protocol)

BACKLIGHT

The value for the backlight is adjustable from 0 to 100 % (full brightness).

- 0 – 100 % (factory setting = 60 %)

SCREENSAVER

The screensaver is disabled as the factory setting. The screensaver can be set for different time periods. Choosing the "DARKROOM" setting switches off the backlight completely after 1 minute. By pressing any key this reactivates the backlight.

- Off (ex factory), 10 minutes, 30 minutes, 1 hour, 2 hours, 8 hours or DARKROOM

CONTRAST LCD

The value for the contrast is adjustable from 0 to 100 % (full contrast).

- 0 – 100 % (factory setting = 40 %)

STANDARD CHARGING

Fig. 32: Press the arrow keys simultaneously > 2 seconds

Reset all the parameters set/changed by the user to the default values (factory settings). **Once you have loaded the default parameters you cannot undo this step.** To load the factory settings, press the “UP” and “DOWN” keys simultaneously. “DEFAULTS LOADED” then appears on the display.

LANGUAGE

The language of the display.

- English (factory setting)
- German
- French

FORMAT

The numeric format of the measured value output in floating decimal or exponential format. If a measured value cannot be illustrated meaningfully in floating decimal format, it is automatically displayed in exponential format.

- X.X (floating decimal number, if displayable (ex factory))
- X.XESY (exponential illustration, e.g. 2.97E2)
- X.XSY (exponential illustration, e.g. 2.97 +2)

END VALUE

The display in case of undershooting or exceeding the measuring range.

- UR/OR (UR or OR displayed (ex factory))
- VALUE (the respective measuring range end value is displayed.)

DHCP (ETH)

Dynamic Host Configuration Protocol. This enables automatic allocation of the network configuration (IP address, subnet mask, gateway) to clients by the server. This function is switched off in the factory settings (manual setting of network configuration). If you switch the function on, the IP address, subnet mask and gateway are automatically set, but cannot be changed.

IP (ETH)

The IP address of the device. You can only change this if DHCP is set to "OFF".

SUBNET (ETH)

The subnet mask of the device. You can only change this if DHCP is set to "OFF".

GATEWAY (ETH)

The gateway address of the device. You can only change this if DHCP is set to "OFF".

7.4.5 Test parameters

Parameter	Description
SOFTWARE VERSION	Firmware version
HARDWARE VERSION	Hardware version
MAC ADDRESS	MAC address
OPERATING HOURS	Operating hours
WATCHDOG	Watchdog error behavior
TORR LOCK	Torr lock
KEY LOCK	Key lock
FLASH TEST	FLASH test (program memory)
EEPROM TEST	EEPROM test (parameter memory)

Parameter	Description
DISPLAY TEST	Display test
RELAY TEST	Relay test
RECALIBRATION	Recalibration

Tbl. 21: Test parameters

The test parameters group includes displaying the firmware version, editing/inputting special parameter values, and the test programs. The parameters in this group are available with all gauges.

The group is only available if

- you press the "Parameters" button when switching on the device, or
- you press the "Parameters" < [REDACTED] button for 5 seconds on the display.

SOFTWARE VERSION

Firmware version (program version) display.

This information is useful if you need to contact Pfeiffer Vacuum.

HARDWARE VERSION

Hardware version display.

This information is useful if you need to contact Pfeiffer Vacuum.

MAC ADDRESS

Displays the MAC address (without separator).

Example: 00-A0-41-0A-00-08 is displayed as 00A0410A0008.

OPERATING HOURS

Operating hours display.

WATCHDOG

Behavior of system monitoring (Watchdog Control) in the event of an error.

- AUTO
 - The system acknowledges a Watchdog malfunction message itself after 2 seconds (factory setting).
- OFF
 - The user must acknowledge a Watchdog malfunction message.

TORR LOCK

Suppression of the Torr and Micron units of measure as a parameter value during setting. This function is disabled in the factory setting.

KEY LOCK

The key lock prevents unintentional input in parameter mode and thus any malfunctions. This function is disabled in the factory setting.

FLASH TEST

Program memory test.



Fig. 33: Program memory test

- RUNNING
 - The test is running (very short).
- OK
 - Test completed, no errors detected. An 8-digit checksum is then displayed, for example 0x12345678.
- ERROR

- Test completed, errors detected. An 8-digit checksum is then displayed, for example 0x12345678.

If the error occurs again when the test is repeated, you should contact your nearest Pfeiffer Vacuum Service Center.

EEPROM TEST

Parameter memory test.



Fig. 34: Parameter memory test

- RUNNING
 - The test is running.
- OK
 - Test completed, no errors detected.
- ERROR
 - Test completed, errors detected.

If the error occurs again when the test is repeated, you should contact your nearest Pfeiffer Vacuum Service Center.

DISPLAY TEST

Display test.

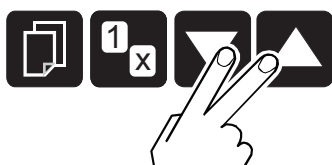

Fig. 35: Display test

After starting the test, all the display elements light up simultaneously for 10 s.

RELAY TEST

NOTICE

Unintentional results with controller connected

Switch relay not dependent on pressure. Values below the intended measuring range, or starting the test program, can result in unintentional results at the connected controller, if the relay switches.

- ▶ Unplug the connected measuring and control cable.
- ▶ Prevent triggering of incorrect control commands or messages.

Test of relays in the device. The test program tests the relays' switching function.



Fig. 36: Test of relays in the device

The relays switch on and off cyclically. The display visually indicates the switching operations. The switching operations also emit a clearly audible sound. The contacts of the switching functions are available at the "control" connection on the rear of the device. You can use an ohmmeter to check the function.

- OFF
 - All relays switched off

- REL1–6
 - Relay switching function 1–6
- REL7
 - Malfunction relay
- REL8-13
 - Internal relay (sensor on/off)

RECALIBRATION

Date of next recalibration. After the set date is reached, "RECALIBRATION REQUIRED!" is displayed.

7.5 Data logger mode

Parameter	Description
DATE	Current date
TIME	Current time
INTERVAL	Interval of measured data recording
DECIMAL POINT	Decimal separator
FILE NAME	File name
START/STOP	Start/stop recording
DELETE	Deletion of files with recorded measured data

Tbl. 22: Parameters in data logger mode

The data logger group includes

- logging measured data onto a USB memory stick (USB interface type A).
- deleting recorded measured data from the USB memory stick.

The group is only available if a USB memory stick (≤ 32 GB) formatted with the FAT file system (FAT32) is plugged in.



USB memory sticks

The device does not recognize all USB memory sticks, for instance if they do not comply with the USB standard. Try using a different memory stick first before you contact your nearest Pfeiffer Vacuum Service Center.

DATE

Current date in format YYYY-MM-DD.

TIME

Current time in format hh:mm [24 h].

INTERVAL

Interval of measured data recording.

- 1 s
 - Recording interval 1/s
- 10 s
 - Recording interval 1/10 s
- 30 s
 - Recording interval 1/30 s
- 1 min
 - Recording interval 1/60 s
- 1 %
 - Recording interval: With measured value changes ≥ 1 %
- 5 %
 - Recording interval: With measured value changes ≥ 5 %

DECIMAL POINT

Decimal point for the measured values with measured data recording (full stop or comma).
The decimal separator is important for further processing with a spreadsheet program.

FILE NAME

Name of the measured data file max. 7 characters. The file extension is CSV.

If the name is shorter than 7 characters, the device requires a space character for the remaining characters. After entering the 7th character, the display stops flashing. The device has stored the name and reverted to read mode.

START/STOP

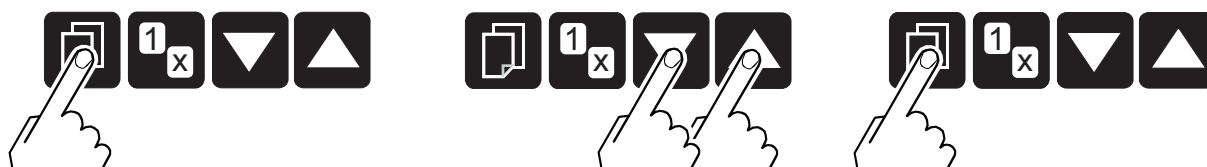

Fig. 37: Start/stop measured data recording

Start/stop measured data recording.

During measured data recording, the number of the corresponding measurement channel flashes.

"UP" arrow button = start saving. Recording is running, the display switches to "STOP" and the "DOWN" arrow flashes.

"DOWN" arrow button = stop saving. Recording stops, the display switches to "START" and the "UP" arrow flashes.

If the arrows are flashing on the display, the device does not automatically revert to measuring mode. You can press the "Parameter" button to quit write mode. The device then automatically reverts to measuring mode after approx. 10 seconds.

DELETE



Fig. 38: Delete files

Delete all measured data files (with CSV file extension) from the USB memory stick.

- RUNNING
 - CSV files are being deleted.
- DONE
 - CSV files have been deleted.

7.6 Setup mode

Parameter	Description
SAVE TO	Save all parameters
RESTORE FROM	Write all parameters to the device
FORMAT	Format the USB memory stick (FAT32)
DELETE	Delete files with stored parameters

Tbl. 23: Parameters in setup mode

This group allows

- all parameters to be saved on a USB memory stick (USB interface type A).
- all parameters to be loaded from a USB memory stick onto the device.

- the formatting of a USB memory stick.
- the deletion of files with stored parameters from the USB memory stick.

The group is only available if a USB memory stick (≤ 32 GB) formatted with the FAT file system (FAT32) is plugged in.

SAVE TO

Save all the device's parameters on a USB memory stick (file: SETUPxx.CSV).

You can choose the file names from SETUP01 to SETUP99.

- RUNNING
 - The device saves the CSV file.
- DONE
 - The save operation is complete.

RESTORE FROM

Load all parameters from a USB memory stick onto the device.

You can choose the file names from SETUP01 to SETUP99.

- RUNNING
 - The device loads the CSV file.
- DONE
 - Loading is complete.
- ERROR
 - An error has occurred.

FORMAT

Format the USB memory stick.

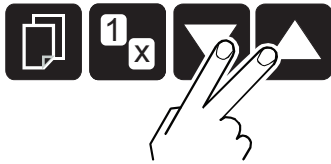

Fig. 39: Formatting the USB memory stick

- RUNNING
 - Formatting is running.
- DONE
 - Formatting is complete.

DELETE

Delete all parameter files (ending with CSV) from the USB memory stick.

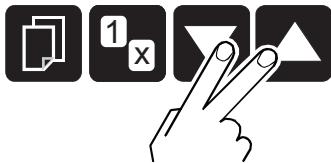

Fig. 40: Delete parameter files from the USB memory stick

- RUNNING
 - The device is deleting the files.
- DONE
 - The device has deleted the files.

8 Decommissioning

Switching the device off

1. Switch off the device at the mains switch.
2. **For rack assembly:** Switch off the device centrally via the switched mains distributor.
3. Wait at least 10 seconds before switching it back on again, so that the device can reinitialize.

9 Maintenance



Maintenance in the Pfeiffer Vacuum Service Center

Pfeiffer Vacuum offers a complete maintenance service for all products.

Pfeiffer Vacuum recommends: Contact your Pfeiffer Vacuum Service Center to arrange the maintenance of defective products and components.



Cleaning in the Pfeiffer Vacuum Service Center

Pfeiffer Vacuum recommends: Contact your nearest Pfeiffer Vacuum Service Center to arrange the cleaning of heavily-soiled products and components.



Do not forget the cleaning

You must ensure that you do not forget the cleaning step, even if you have constructed the product in such a way that contamination is not easily detected.



Loss of warranty claims

The following will result in the loss of the warranty:

- Damage to or removal of a closure seal
- Opening the device during the warranty period

Contact the Pfeiffer Vacuum Service Center in the event of process-related shorter maintenance intervals.



First read through the sections completely

Read the section with the work instructions through completely first before you commence with work.

9.1 Cleaning the device

DANGER

Electric shocks due to moisture penetrating into the device

Water that has penetrated into the device results in personal injury through electric shocks.

- ▶ Only operate the device in a dry environment.
- ▶ Operate the device away from fluids and humidity sources.
- ▶ Do not switch on the device if fluid has penetrated into it, instead contact Pfeiffer Vacuum Service.
- ▶ Always disconnect the current supply before cleaning the device.

WARNING

Health hazards due to cleaning agent

The cleaning agents used cause health hazards.

- ▶ When handling cleaning agents, observe the applicable regulations.
- ▶ Adhere to safety measures regarding handling and disposal of cleaning agents.
- ▶ Be aware of potential reactions with product materials.

NOTICE**Damage caused by penetrating moisture**

Penetrating moisture, e.g. through condensation or dripping water, damages the device.

- ▶ Protect the device against moisture penetrating.
- ▶ Only operate the device in a clean and dry environment.
- ▶ Operate the device away from fluids and humidity sources.
- ▶ Take special precautions if there is a risk of dripping water.
- ▶ Do not switch on the device if fluid has penetrated into it, instead contact the Pfeiffer Vacuum Service Center.

NOTICE**Damage caused by unsuitable cleaning agents**

Unsuitable cleaning agents damage the product.

- ▶ Do not use solvents as they attack the surface.
- ▶ Do not use any aggressive or abrasive cleaning agents.

Cleaning the device**Required consumables**

- Common cleaning agent (e.g. mild detergent).
 - Soft cloth
1. Switch the device off and disconnect it from the network.
 2. Use a soft, damp cloth to clean the surfaces.
 3. Allow the surfaces to dry thoroughly after cleaning.

9.2 Replacing the battery

The product contains a battery (type CR2032, service life > 10 years), in order to maintain the data integrity of the real-time clock. A battery replacement is necessary if the real-time clock repeatedly displays an incorrect date. To arrange for the battery to be replaced, you must contact your nearest Pfeiffer Vacuum Service Center.

10 Errors

The error appears and the error relay opens.



Error cannot be eliminated

If the error persists even after it has been acknowledged and/or the gauge has been replaced several times, please contact your nearest Pfeiffer Vacuum Service Center.

Defect	Possible cause	Remedy/acknowledgment
Display: SENSOR ERROR	Interruption or interference in the connection to the gauge (sensor error).	Acknowledge with the "Parameter" key. If the cause is not remedied, NO SENSOR or NO IDENT appears.
Display: WATCH-DOG ERROR	After switching off, the unit was switched on again too quickly.	Acknowledge with the "Parameter" key. If the watchdog is set to Auto, the device self-acknowledges after 2 s.
	The watchdog was tripped by a serious electrical fault or operating system error.	
Display: UART ERROR	Error in the UART.	Acknowledge with the "Parameter" key.
Display: PROGRAM CORRUPT	Error in program memory (FLASH).	Acknowledge with the "Parameter" key.
Display: DATA CORRUPT	Error in the parameter memory (EEPROM).	Acknowledge with the "Parameter" key.
Display: DISPLAY ERROR	Error in the display driver.	Acknowledge with the "Parameter" key.
Display: A/D ERROR	Error in the A/D converter.	Acknowledge with the "Parameter" key.
No supply to gauge	Overcurrent protection (fuse protection)	Switch off the device or Unplug the gauge connector

Tbl. 24: Errors

11 Shipping

WARNING

Risk of poisoning from contaminated products

Where products that contain harmful substances are shipped for maintenance or repair purposes, the safety of service personnel is at risk.

- ▶ Comply with the instructions for safe shipping.

Instructions for safe shipping



Decontamination subject to charge

Pfeiffer Vacuum decontaminates products not clearly declared "Free of contamination" at your expense.

1. Do not ship microbiological, explosive or radioactively contaminated products!
2. Observe the shipping guidelines for the participating countries and transport companies.
3. Designate the dangers on the outside of the packaging.
4. Download the declaration of contamination. ([Pfeiffer Vacuum Service](#)).
5. Always enclose a completed declaration of contamination!

12 Disposal

⚠ WARNING

Health hazard through poisoning from toxic contaminated components or devices

Toxic process media result in contamination of devices or parts of them. During maintenance work, there is a risk to health from contact with these poisonous substances. Illegal disposal of toxic substances causes environmental damage.

- ▶ Take suitable safety precautions and prevent health hazards or environmental pollution by toxic process media.
- ▶ Decontaminate affected parts before carrying out maintenance work.
- ▶ Wear protective equipment.

⚠ CAUTION

Health hazard caused by environmentally hazardous substances

Products, operating fluid, electric components, calibration gas residues (for example from test leaks) or similar pose health hazards.

- ▶ Dispose of the environmentally hazardous substances in accordance with local regulations.
- ▶ Dispose of calibration gas and test leaks in accordance with local regulations.

Dividing components

- ▶ After disassembly, divide the components into the following categories with regard to disposal:
 - contaminated components that had contact with process gases
 - non-contaminated components that had no contact with process gases

Disposal of contaminated components that have contact with process gases

1. Dispose of the substances in a safe manner in accordance with the locally applicable regulations if the process gases used were contaminated, e.g. radioactive, toxic, caustic or a microbiological manner.
2. Observe the environment and safety provisions of the respective country.

Disposal of components that do not have contact with process gases

1. Separate the components according to their type of material:
 - electronic components
 - electrical components
 - battery and rechargeable batteries
 - mechanical components
2. Recycle the components.
3. Dispose of the substances in a safe manner according to locally applicable regulations.
4. Observe the environment and safety provisions of the respective country.

13 Service solutions from Pfeiffer Vacuum

We offer first class service

Long vacuum component service life, coupled with low downtimes, are clear expectations that you have of us. We satisfy your needs with capable products and outstanding service.

We are consistently striving to perfect our core competence, service for vacuum components. And our service is far from over once you've purchased a product from Pfeiffer Vacuum. It often enough really just begins then. In proven Pfeiffer Vacuum quality, of course.

Our professional sales engineers and service technicians stand ready to provide hands-on support to you worldwide. Pfeiffer Vacuum offers a complete portfolio of service offerings, ranging from genuine spare parts right through to service agreements.

Take advantage of Pfeiffer Vacuum Service

Whether for preventative on-site service from our field service, fast replacement with as-new replacement products or repair in a Service Center close to you; you have various options for upholding your equipment availability. Detailed information and addresses can be found on our website in the Pfeiffer Vacuum Service section.

Advice on the optimum solution is available from your Pfeiffer Vacuum contact partner.

For quick and smooth handling of the service process, we recommend the following steps:



1. Download the current form templates.
 - [Declaration of Service Request](#)
 - [Service Request](#)
 - [Declaration of Contamination](#)

- a. Dismantle all accessories and keep them (all external mounted parts as valve, inlet screen, etc.).
- b. Drain the operating fluid/lubricant as necessary.
- c. Drain the cooling medium as necessary.



2. Fill out the service request and the declaration of contamination.



3. Send the forms via email, fax or post to your local Service Center.

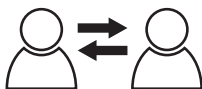

4. You will receive a response from Pfeiffer Vacuum.

PFEIFFER VACUUM

Sending of contaminated products

No units will be accepted if they are contaminated with micro-biological, explosive or radioactive substances. If products are contaminated or if the declaration of contamination is missing, Pfeiffer Vacuum will contact the customer before starting maintenance. In addition, depending on the product and the level of contamination **additional decontamination costs** may be required.

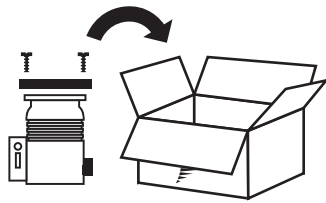

5. Prepare the product for transport in accordance with the details in the declaration of contamination.
 - a) Neutralize the product with nitrogen or dry air.
 - b) Close all openings with airtight blank flanges.
 - c) Seal the product in appropriate protective film.
 - d) Only pack the product in suitable, stable transport containers.
 - e) Observe the applicable transport conditions.

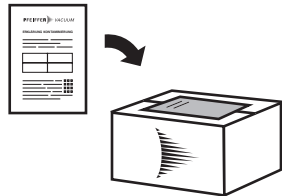

6. Affix the declaration of contamination to the **outside** of the packaging.

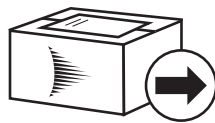

7. Then send your product to your local [Service Center](#).

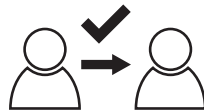

8. You will receive a confirmation message/a quotation from Pfeiffer Vacuum.

PFEIFFER VACUUM

For all service orders, our [General Terms and Conditions of Sales and Supply](#) and [General Terms and Conditions of Repair and Maintenance](#) apply to vacuum equipment and components.

14 Technical data and dimensions

14.1 Technical data

General

Parameter	Value
Use	For rack installation, control panel installation or as a tabletop device
Weight	< 2.2 kg

Tbl. 25: Technical data (general)

Mains power supply

Parameter	Value
Voltage	100 – 240 V (AC) $\pm 10\%$
Frequency	50 – 60 Hz
Power input	≤ 200 VA
Excess voltage category	II
Protection class	1
Connection	(see chapter "Mains power supply", page 23)

Tbl. 26: Technical data (mains connection)

Ambient conditions

Parameter	Value
Storage temperature, max.	-20 – 60 °C
Operating temperature, max.	5 – 38 °C (sensor load 150 W)
	5 – 50 °C (sensor load 100 W)
Relative humidity	$\leq 80\%$ to +31 °C, decreasing to 50 % at +40 °C
Use	Only in indoor areas
Installation altitude max.	2000 m NN
Degree of contamination	II
Protection system, class, category	IP30

Tbl. 27: Technical data (ambient conditions)

Gauge connections

Parameter	Value
Quantity, number	6
Connection	(see chapter "sensor connection", page 24)
Connectable gauges:	
TPR 261, TPR 265, TPR 270, TPR 271, TPR 280, TPR 281, PPT 200 AR	
PCR 260, PCR 280, RPT 200 AR	

Parameter	Value
	IKR 251, IKR 261, IKR 270, IKR 360, IKR 361
	PKR 251, PKR 261, PKR 360, PKR 361, MPT 200 AR
	IMR 265
	PBR 260, HPT 200 AR
	CMR 261 – CMR 275, CMR 361 – CMR 375
	APR 250 – APR 267, CPT 200 AR

Tbl. 28: Technical data (gauge connections)

Gauge supply voltage

Parameter	Value
Voltage	+24 V (DC) $\pm 5\%$
Ripple	$< \pm 1\%$
Current	0 – 1 A (per channel)
Power	25 W (per channel)
Fuse	1.5 A (per channel) with PTC element, self-resetting after switching off the device or unplugging the gauge plug. The voltage supply meets the requirements of an protected extra-low voltage.

Tbl. 29: Technical data (gauge supply)

Operation

Parameter	Value
Front panel	4 control buttons
Remote control	RS-485 interface, USB type B interface, Ethernet interface

Tbl. 30: Technical data (operation)

Measured values

Parameter	Value
Measuring ranges	Gauge-dependent
Measuring error (amplification error)	$\leq 0.01\%$ F.S. (typical), $\leq 0.10\%$ F.S. (over temperature range, time)
Measuring error (offset error)	$\leq 0.01\%$ F.S. (typical), $\leq 0.10\%$ F.S. (over temperature range, time)
Measuring rate analog	$\geq 100 / s$
Display rate	$\geq 10 / s$
Filter time constant (slow)	750 ms ($f_g = 0.2$ Hz)
Filter time constant (normal)	150 ms ($f_g = 1$ Hz)
Filter time constant (fast)	20 ms ($f_g = 8$ Hz)
Unit of measure	mBar, hPa, Torr, Pa, Micron, V
Offset correction	For linear gauges -5 – 110% F.S.
Calibration factor	0.10 – 10.00
A/D conversion	Resolution 0.001 % F.S.

Tbl. 31: Technical data (measured values)
Switching functions

Parameter	Value
Quantity, number	6 (freely assignable)
Response time	≤ 10 ms, if the threshold value is near the measured value (note the filter time constant if there is a large difference).
Setting range	Gauge-dependent
Hysteresis	≥ 1 % F.S. for linear gauges, ≥ 10 % of the measured value for logarithmic gauges

Tbl. 32: Technical data (switching functions)
Switching function relay

Parameter	Value
Contact type	Zero-potential two-way contact
Load max.	60 V (DC), 0.5 A, 30 W (ohmic) 30 V (AC), 1 A (ohmic)
Service life (mechanical)	$1 \cdot 10^8$ Switching cycles
Service life (electrical)	$1 \cdot 10^5$ Duty cycles (at maximum load)
Contact settings	(see chapter ""relay" connection", page 25)
Connection	

Tbl. 33: Technical data (switching function relay)
Error signal (error)

Parameter	Value
Quantity, number	1
Response time	≤ 10 ms

Tbl. 34: Technical data (error signal (error))
Error signal relay

Parameter	Value
Contact type	Zero-potential two-way contact
Load max.	60 V (DC), 0.5 A, 30 W (ohmic) 30 V (AC), 1 A (ohmic)
Service life (mechanical)	$1 \cdot 10^8$ Switching cycles
Service life (electrical)	$1 \cdot 10^5$ Duty cycles (at maximum load)
Contact settings	(see chapter ""control" connection", page 24)
Connection	

Tbl. 35: Technical data (error signal relay)

Gauge control

Parameter	Value
Switch on/off automatically	Switch on/off threshold value adjustable (see chapter "Gauge control", page 44)
Switch on/off via buttons	(see chapter "Measuring mode", page 36)
Switch on/off via "control" connection	Switch-on criterion: Signal $\leq +0.8$ V (DC) Switch-off criterion: Signal $+2.0 - 5$ V (DC) or input open (see chapter "'control' connection", page 24)
switch on with mains voltage	(see chapter "Gauge control", page 44)
with pressure rise	Switch-off threshold value adjustable (see chapter "Gauge control", page 44)

Tbl. 36: Technical data (gauge control)

Analog outputs

Parameter	Value
Quantity, number	6 (1 per channel)
Voltage range	0 to +10 V (DC)
Deviation from the display value	± 10 mV
Output resistance	$< 50 \Omega$
Measurement signal to pressure ratio	Gauge-dependent
Connection	(see chapter "'control' connection", page 24)

Tbl. 37: Technical data (analog outputs)

RS-485 interface

Parameter	Value
PROTOCOL	ACK/NAK, ASCII with 3 character mnemonics or PV protocol
Data format	Two-way data traffic, 1 start bit, 8 data bits, 1 stop bit, no parity bit, no handshake
Baudrate	9600
Connection	(see chapter "Connection "RS-485"", page 25)

Tbl. 38: Technical data (RS-485 interface)

USB interface (type A)

Parameter	Value
PROTOCOL	FAT file system File processing in ASCII format

Tbl. 39: Technical data (USB interface (type A))

USB interface (type B)

Parameter	Value
PROTOCOL	ACK/NAK, ASCII with 3 character mnemonics or PV protocol
Data format	Two-way data traffic, 1 start bit, 8 data bits, 1 stop bit, no parity bit, no handshake
Baudrate	9600, 19200, 38400, 57600, 115200

Tbl. 40: Technical data (USB interface (type B))

Ethernet interface

Parameter	Value
PROTOCOL	ACK/NAK, ASCII with 3 character mnemonics or PV protocol
Data format	Two-way data traffic, 1 start bit, 8 data bits, 1 stop bit, no parity bit, no handshake
Baudrate	9600, 19200, 38400, 57600, 115200
IP address	DHCP or manual entry, port 8000 (fix)
MAC address	readable via "MAC" parameter

Tbl. 41: Technical data (Ethernet interface)

14.2 Dimensions

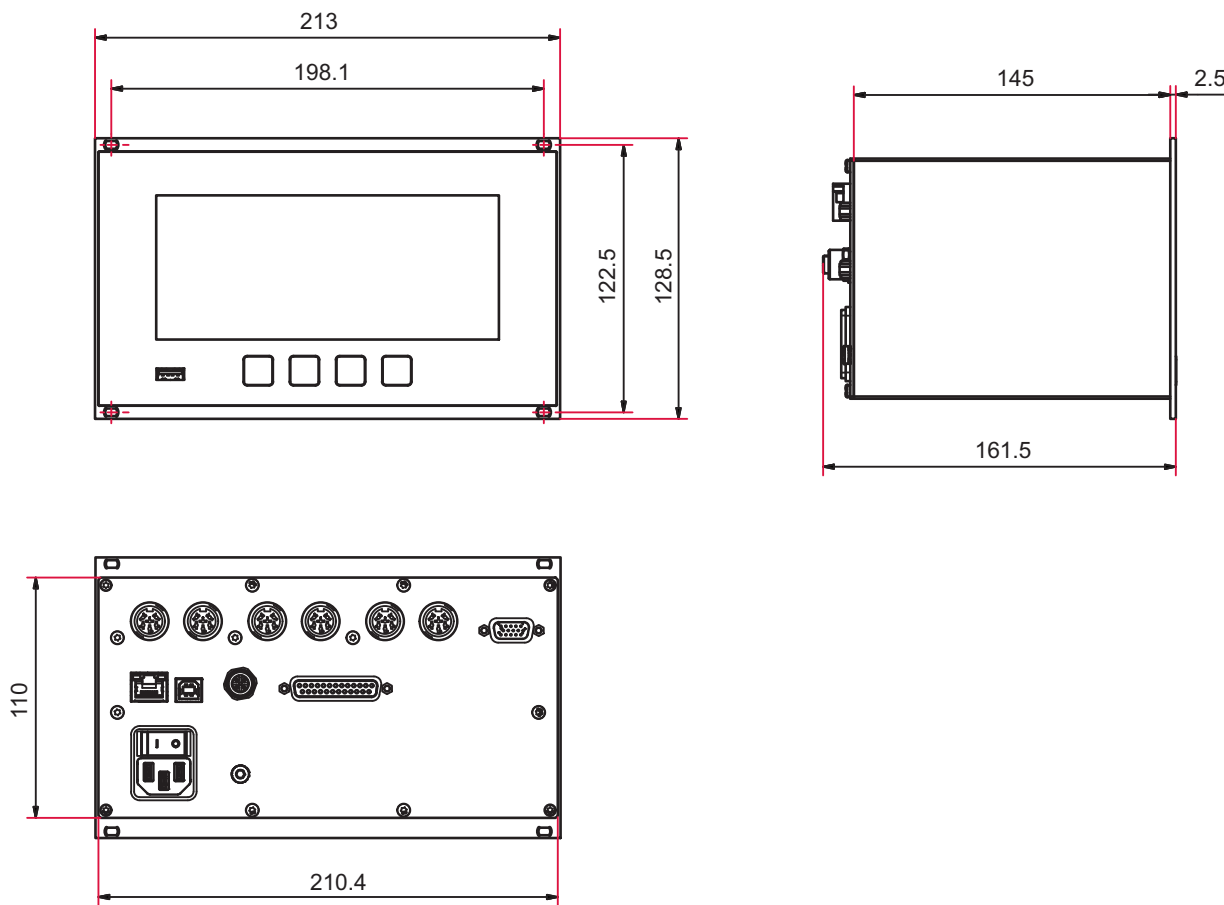

Fig. 41: Dimensions TPG 366 (in mm)

15 Appendix

15.1 Units of pressure

Unit	mbar	bar	Pa	hPa	kPa	Torr / mm Hg
mbar	1	$1 \cdot 10^{-3}$	100	1	0.1	0.75
bar	1000	1	$1 \cdot 10^5$	1000	100	750
Pa	0.01	$1 \cdot 10^{-5}$	1	0.01	$1 \cdot 10^{-3}$	$7.5 \cdot 10^{-3}$
hPa	1	$1 \cdot 10^{-3}$	100	1	0.1	0.75
kPa	10	0.01	1000	10	1	7.5
Torr / mm Hg	1.33	$1.33 \cdot 10^{-3}$	133.32	1.33	0.133	1

1 Pa = 1 N/m²

Tbl. 42: Units of pressure and their conversion

15.2 Gas throughputs

Unit	mbar l/s	Pa m ³ /s	sccm	Torr l/s	atm cm ³ /s
mbar l/s	1	0.1	59.2	0.75	0.987
Pa m ³ /s	10	1	592	7.5	9.87
sccm	$1.69 \cdot 10^{-2}$	$1.69 \cdot 10^{-3}$	1	$1.27 \cdot 10^{-2}$	$1.67 \cdot 10^{-2}$
Torr l/s	1.33	0.133	78.9	1	1.32
atm cm ³ /s	1.01	0.101	59.8	0.76	1

Tbl. 43: Gas throughputs and their conversion



Intertek
4010094

ETL LISTED

The products TPG 361, TPG 362 and TPG 366

- conform to the UL standards
UL 61010-1 and UL 61010-2-030.

- are certified to the CAN/CSA standards
CAN/CSA C22.2 No. 61010-1-12 and CAN/CSA C22.2 No. 61010-2-030.



Declaration of conformity

We hereby declare that the product cited below satisfies all relevant provisions of the following **EU Directives**:

- **Low voltage 2014/35/EC**
- **Electromagnetic compatibility 2014/30/EU**
- **Restriction of the use of certain hazardous substances 2011/65/EU**

Total pressure measuring and control unit

TPG 366

Harmonized standards and applied national standards and specifications:

DIN EN 61000-3-2:2015-03

DIN EN 61000-3-3:2014-03

DIN EN 61000-6-1:2007-10

DIN EN 61000-6-2:2006-03

DIN EN 61000-6-3:2011-09

DIN EN 61000-6-4:2011-09

DIN EN 61010-1:2011-07

DIN EN 61326-1:2013-07

Signature:

Pfeiffer Vacuum GmbH
Berliner Straße 43
35614 Aßlar
Germany

(Dr. Ulrich von Hülsen)
Managing Director

Aßlar, 2017-03-24



VACUUM SOLUTIONS FROM A SINGLE SOURCE

Pfeiffer Vacuum stands for innovative and custom vacuum solutions worldwide, technological perfection, competent advice and reliable service.

COMPLETE RANGE OF PRODUCTS

From a single component to complex systems:

We are the only supplier of vacuum technology that provides a complete product portfolio.

COMPETENCE IN THEORY AND PRACTICE

Benefit from our know-how and our portfolio of training opportunities!

We support you with your plant layout and provide first-class on-site service worldwide.

ed. B - Date 1811 - P/N:BG5501BEN



Are you looking for a
perfect vacuum solution?
Please contact us

Pfeiffer Vacuum GmbH
Headquarters • Germany
T +49 6441 802-0
info@pfeiffer-vacuum.de

www.pfeiffer-vacuum.com

PFEIFFER  **VACUUM**