



# OPERATING INSTRUCTIONS

EN

Translation of the Original

## TPG 500

Total pressure measuring and control unit

**PFEIFFER**  **VACUUM**

---

## Dear Customer,

Thank you for choosing a Pfeiffer Vacuum product. Your new total pressure measuring and control unit should support you in your individual application with full performance and without malfunctions. The name Pfeiffer Vacuum stands for high-quality vacuum technology, a comprehensive and complete range of top-quality products and first-class service. From this extensive, practical experience we have gained a large volume of information that can contribute to efficient deployment and to your personal safety.

In the knowledge that our product must avoid consuming work output, we trust that our product can offer you a solution that supports you in the effective and trouble-free implementation of your individual application.

Please read these operating instructions before putting your product into operation for the first time. If you have any questions or suggestions, please feel free to contact [info@pfeiffer-vacuum.de](mailto:info@pfeiffer-vacuum.de).

Further operating instructions from Pfeiffer Vacuum can be found in the [Download Center](#) on our website.

## Disclaimer of liability

These operating instructions describe all models and variants of your product. Note that your product may not be equipped with all features described in this document. Pfeiffer Vacuum constantly adapts its products to the latest state of the art without prior notice. Please take into account that online operating instructions can deviate from the printed operating instructions supplied with your product.

Furthermore, Pfeiffer Vacuum assumes no responsibility or liability for damage resulting from the use of the product that contradicts its proper use or is explicitly defined as foreseeable misuse.

## Copyright

This document is the intellectual property of Pfeiffer Vacuum and all contents of this document are protected by copyright. They may not be copied, altered, reproduced or published without the prior written permission of Pfeiffer Vacuum.

We reserve the right to make changes to the technical data and information in this document.

# Table of contents

<b>1</b>	<b>About this manual</b>	<b>8</b>
1.1	Validity	8
	1.1.1 Applicable documents	8
	1.1.2 Variants	8
	1.1.3 Firmware versions	8
1.2	Target group	8
1.3	Conventions	9
	1.3.1 Instructions in the text	9
	1.3.2 Pictographs	9
	1.3.3 Stickers on the product	9
	1.3.4 Abbreviations	9
1.4	Trademark proof	10
<b>2</b>	<b>Safety</b>	<b>11</b>
2.1	General safety information	11
2.2	Safety instructions	11
2.3	Safety precautions	14
2.4	Proper use	15
2.5	Foreseeable improper use	15
2.6	Responsibilities and warranty	15
2.7	Owner requirements	16
2.8	Personnel qualification	16
	2.8.1 Ensuring personnel qualification	16
	2.8.2 Personnel qualification for maintenance and repair	16
	2.8.3 Advanced training with Pfeiffer Vacuum	17
2.9	Operator requirements	17
<b>3</b>	<b>Product description</b>	<b>18</b>
3.1	Structure	18
3.2	Display elements	19
3.3	Controls	20
3.4	Interfaces	21
	3.4.1 Mains connection	21
	3.4.2 Ground terminal	21
	3.4.3 "CONTROL" connection	21
	3.4.4 "RS-485" connector	22
	3.4.5 "USB" connection (type A)	22
	3.4.6 "USB" connection (type B)	23
	3.4.7 "Ethernet" (LAN) connection	23
3.5	Identifying the product	23
3.6	Scope of delivery	24
<b>4</b>	<b>Transport and storage</b>	<b>25</b>
4.1	Transporting the product	25
4.2	Storing the product	25
<b>5</b>	<b>Installation</b>	<b>26</b>
5.1	Installing device in a 19" rack	26
5.2	Installing device in a switchboard	27
5.3	Using device as a desktop device	28
5.4	Establishing a grounding connection	29
5.5	Connecting to mains power supply	29
5.6	Fitting device with plug-in boards	30
<b>6</b>	<b>Commissioning</b>	<b>31</b>
6.1	Switch on the device	31
6.2	Configuring Ethernet	31

<b>7</b>	<b>Operation</b>	<b>33</b>
7.1	Using buttons	33
7.2	Converting measurement signal	33
7.2.1	Conversion for Pirani gauges	34
7.2.2	Conversion for Penning gauges on measuring board CP 300 C9	35
7.2.3	Conversion for Penning gauges on measuring board CP 300 C10	37
7.2.4	Conversion for Penning gauges on measuring board CP 300 T11/ T11L	39
7.3	Measuring with TPG 500	41
7.3.1	Gas type dependence	41
7.3.2	Validity of the display	41
7.3.3	Accuracy of the measured value display	41
7.3.4	Calibration	41
<b>8</b>	<b>Operating modes</b>	<b>42</b>
8.1	Using measuring mode	42
8.1.1	Changing measurement channel	42
8.1.2	Switching measuring circuit on and off	42
8.1.3	Measured value display	43
8.1.4	Identifying measuring board and gauge	43
8.1.5	Resetting unit to the factory settings	44
8.2	Using parameter mode	44
<b>9</b>	<b>Configuring parameters</b>	<b>46</b>
9.1	Switching function parameters	46
9.2	Gauge parameters	47
9.2.1	"FILTER" parameter	47
9.2.2	"GAS TYPE" parameter	48
9.2.3	"CORRECTION FACTOR" parameter	48
9.2.4	"NAME" parameter	48
9.2.5	"COMPENSATION" parameter	48
9.3	Gauge control	48
9.3.1	"SENSOR ON" parameter	48
9.3.2	"SENSOR OFF" parameter	49
9.3.3	"THRESHOLD ON" parameter	49
9.3.4	"THRESHOLD OFF" parameter	49
9.4	General parameters	50
9.4.1	"UNIT" parameter	50
9.4.2	"ANALOG OUTPUT" parameter	50
9.4.3	"ERROR RELAY" parameter	50
9.4.4	"PENNING-UR" parameter	51
9.4.5	"BARGRAPH / GRAPH" parameter	51
9.4.6	"CONTRAST LCD" parameter	52
9.4.7	"BACKLIGHT" parameter	52
9.4.8	"SCREENSAVER" parameter	52
9.4.9	"SET DEFAULTS" parameter	52
9.4.10	"LANGUAGE" parameter	52
9.4.11	"END VALUE" parameter	52
9.5	Communication parameters	53
9.5.1	"BAUD RATE USB" parameter	53
9.5.2	"BAUD RATE IFxxx" parameter	53
9.5.3	"BAUD RATE RS485" parameter	53
9.5.4	"RS485 ADDRESS" parameter	53
9.5.5	"PROTOCOL" parameter	54
9.5.6	"DHCP (ETH)" parameter	54
9.5.7	"IP (ETH)" parameter	54
9.5.8	"SUBNET (ETH)" parameter	54
9.5.9	"GATEWAY (ETH)" parameter	54

9.6	Plug-in board parameters	54
9.7	Data logger mode	55
9.7.1	"MODE" parameter	55
9.7.2	"DATE" parameter	56
9.7.3	"TIME" parameter	56
9.7.4	"INTERVAL" parameter	56
9.7.5	"DEC-SEPARATOR" parameter	56
9.7.6	"FILE NAME" parameter	56
9.7.7	"START / STOP" parameter	56
9.7.8	"CLEAR" parameter	57
9.8	Setup mode	57
9.8.1	"SAVE TO" parameter	57
9.8.2	"RESTORE FROM" parameter	57
9.8.3	"FORMAT" parameter	58
9.8.4	"CLEAR" parameter	58
9.9	Test parameters	58
9.9.1	"WATCHDOG" parameter	58
9.9.2	"FLASH TEST" parameter	59
9.9.3	"EEPROM TEST" parameter	59
9.9.4	"DISPLAY TEST" parameter	59
9.9.5	"RELAY TEST" parameter	59
9.9.6	"RECALIBRATION" parameter	60
<b>10</b>	<b>Decommissioning</b>	<b>61</b>
<b>11</b>	<b>Maintenance</b>	<b>62</b>
11.1	Cleaning the device	62
11.2	Replacing the battery	63
11.3	Updating firmware	63
<b>12</b>	<b>Malfunctions</b>	<b>66</b>
<b>13</b>	<b>Shipping</b>	<b>67</b>
<b>14</b>	<b>Recycling and disposal</b>	<b>68</b>
14.1	General disposal information	68
14.2	Dispose of a total pressure measuring and control unit	68
<b>15</b>	<b>Service solutions by Pfeiffer Vacuum</b>	<b>69</b>
<b>16</b>	<b>Accessories</b>	<b>71</b>
16.1	Accessory information	71
16.2	Ordering accessories	71
<b>17</b>	<b>Technical data and dimensions</b>	<b>72</b>
17.1	General	72
17.2	Technical data	72
17.3	Dimensions	75
	<b>ETL certification</b>	<b>76</b>
	<b>Declaration of Conformity</b>	<b>77</b>

## List of tables

Tbl. 1:	Applicable documents	8
Tbl. 2:	Variants	8
Tbl. 3:	Abbreviations used	10
Tbl. 4:	Controls	20
Tbl. 5:	Switching functions	22
Tbl. 6:	Status of the Ethernet connection	23
Tbl. 7:	Functional principle of buttons	33
Tbl. 8:	Constant for converting output voltage and pressure for Pirani gauges	35
Tbl. 9:	Constant for converting output current and pressure for Pirani gauges	35
Tbl. 10:	Constant for converting output voltage and pressure for Penning gauges on measuring board CP 300 C9	36
Tbl. 11:	Constant for converting output current and pressure for Penning gauges on measuring board CP 300 C9	37
Tbl. 12:	Constant for converting output voltage and pressure for Penning gauges on measuring board CP 300 C10	38
Tbl. 13:	Constant for converting output current and pressure for Penning gauges on measuring board CP 300 C10	39
Tbl. 14:	Constant for converting output voltage and pressure for Penning gauges on measuring board CP 300 T11/T11L	40
Tbl. 15:	Constant for converting output current and pressure for Penning gauges on measuring board CP 300 T11/T11L	41
Tbl. 16:	Displays for measuring circuits	43
Tbl. 17:	Switching function parameters	46
Tbl. 18:	Examples of switching function displays	47
Tbl. 19:	Gauge parameters	47
Tbl. 20:	Gauge control	48
Tbl. 21:	General parameters	50
Tbl. 22:	Communication parameters	53
Tbl. 23:	Plug-in board parameters	54
Tbl. 24:	Examples of displays for plug-in board parameters	55
Tbl. 25:	Parameters in data logger mode	55
Tbl. 26:	Parameters in setup mode	57
Tbl. 27:	Examples for displays in setup mode	57
Tbl. 28:	Test parameters	58
Tbl. 29:	Malfunctions	66
Tbl. 30:	Measuring boards	71
Tbl. 31:	Interfaces and relay boards	71
Tbl. 32:	Dummy plates	71
Tbl. 33:	Conversion table: Pressure units	72
Tbl. 34:	Conversion table: Units for gas throughput	72
Tbl. 35:	General technical data	72
Tbl. 36:	Mains connection	72
Tbl. 37:	Ambient conditions	73
Tbl. 38:	Plug-in positions for plug-in boards	73
Tbl. 39:	Operation	73
Tbl. 40:	Measured values	73
Tbl. 41:	Switching functions	73
Tbl. 42:	Relay contacts	74
Tbl. 43:	Reversible analog outputs	74
Tbl. 44:	RS-485 interface	74
Tbl. 45:	USB interface (type A)	74
Tbl. 46:	USB interface (type B)	74
Tbl. 47:	Ethernet interface	74

## List of figures

Fig. 1:	Disconnect device in accordance with EN 61010-1	15
Fig. 2:	Front panel	18
Fig. 3:	Connections on the rear side	18
Fig. 4:	Display elements of the device	19
Fig. 5:	Parameter or bar graph	19
Fig. 6:	Switch-points 1–4, parameter mode and input lock	20
Fig. 7:	Measurement channel status	20
Fig. 8:	Mains connection with main switch and IEC 320 C13 socket	21
Fig. 9:	"CONTROL" connection (25-pole D-Sub socket)	22
Fig. 10:	"RS-485" connection (5-pin Binder M12 socket)	22
Fig. 11:	"USB" connection (type A)	23
Fig. 12:	"USB" connection (type B)	23
Fig. 13:	"Ethernet" (LAN) connection	23
Fig. 14:	Guide rail	26
Fig. 15:	19" rack module adapter as per DIN 41 494 (height 3)	26
Fig. 16:	Device installation	27
Fig. 17:	Required switchboard cut-out	28
Fig. 18:	Fasten the rubber feet and rubber strip	28
Fig. 19:	Connect the power supply cable	30
Fig. 20:	Connection via virtual COM interface or via Winsock /Telnet	31
Fig. 21:	Ethernet Configuration Tool	32
Fig. 22:	Relationship between output voltage and pressure for Pirani gauges	34
Fig. 23:	Relationship between output current and pressure for Pirani gauges	34
Fig. 24:	Relationship between output voltage and pressure for Penning gauges on measuring board CP 300 C9	35
Fig. 25:	Relationship between output current and pressure for Penning gauges on measuring board CP 300 C9	36
Fig. 26:	Relationship between output voltage and pressure for Penning gauges on measuring board CP 300 C10	37
Fig. 27:	Relationship between output current and pressure for Penning gauges on measuring board CP 300 C10	38
Fig. 28:	Relationship between output voltage and pressure for Penning gauges on measuring board CP 300 T11/T11L	39
Fig. 29:	Relationship between output current and pressure for Penning gauges on measuring board CP 300 T11/T11L	40
Fig. 30:	Changing measurement channel	42
Fig. 31:	Switching measuring circuit on and off	42
Fig. 32:	Measuring range	43
Fig. 33:	Identifying measuring board and gauge	43
Fig. 34:	Resetting unit to the factory settings	44
Fig. 35:	Reading/writing parameter groups and parameters	45
Fig. 36:	Switching functions and threshold values	46
Fig. 37:	Examples for measured value filters: OFF, 10 Hz and 1 Hz (from left to right)	47
Fig. 38:	USB Update Tool	65
Fig. 39:	Dimensions	75

# 1 About this manual



**IMPORTANT**

Read carefully before use.  
Keep the manual for future consultation.

## 1.1 Validity

This document describes the function of the products listed in the following and provides the most important information for safe use. The description is written in accordance with the valid directives. The information in this document refers to the current development status of the products. The document retains its validity assuming that the customer does not make any changes to the product.

### 1.1.1 Applicable documents

Designation	Document
Installation instructions "Total pressure measuring and control unit" TPG 500	BG 6007
Communication instructions "Total pressure measuring and control unit" TPG 500	BG 6009
Operating instructions "Plug-in boards" Measuring boards, interface boards and relay boards	BG 5972
Operating instructions "Gauges" ModulLine gauges	(depending on the gauge used)
Declaration of conformity	(Component of these instructions)

**Tbl. 1: Applicable documents**

You can find these documents in the [Pfeiffer Vacuum Download Center](#).

### 1.1.2 Variants

This document applies for the product with the following part number:

Part number	Designation
PT G28 500	TPG 500

**Tbl. 2: Variants**

You can find the part number on the rating plate of the product.

Pfeiffer Vacuum reserves the right to make technical changes without prior notification.

The figures in this document are not to scale.

Dimensions are in mm unless stated otherwise.

### 1.1.3 Firmware versions

This document is based on firmware version **V010300**. Older firmware versions do not have the full functionality described in these operating instructions.

**Checking the firmware version**

1. If the device is not functioning as it did before, check whether the correct firmware version is installed.
2. If you have any questions about the firmware, contact Pfeiffer Vacuum.

## 1.2 Target group

These operating instructions are aimed at all persons performing the following activities on the product:



- Transportation
- Setup (Installation)
- Usage and operation
- Decommissioning
- Maintenance and cleaning
- Storage or disposal

The work described in this document is only permitted to be performed by persons with the appropriate technical qualifications (expert personnel) or who have received the relevant training from Pfeiffer Vacuum.

## 1.3 Conventions

### 1.3.1 Instructions in the text

Usage instructions in the document follow a general structure that is complete in itself. The required action is indicated by an individual step or multi-part action steps.

#### Individual action step

A horizontal, solid triangle indicates the only step in an action.

- ▶ This is an individual action step.

#### Sequence of multi-part action steps

The numerical list indicates an action with multiple necessary steps.

1. Step 1
2. Step 2
3. ...

### 1.3.2 Pictographs

Pictographs used in the document indicate useful information.





Note



Tip

### 1.3.3 Stickers on the product

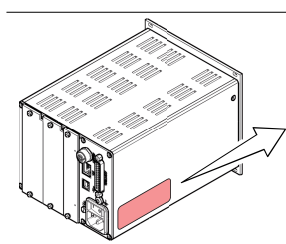
This section describes all the stickers on the product along with their meanings.

 <div data-bbox="654 1523 973 1646" style="border: 1px solid black; padding: 5px;"> <p><b>PFEIFFER</b> VACUUM</p> <p>D-35614 Asslar</p> <p>Mod. TPG 500</p> <p>P/N PT G28 500</p> <p>S/N xxxxxxxxx</p> <p>Input 100-240 V AC 50-60 Hz 65 W</p> <p>Made in Romania 2022/03</p>   </div>	<p><b>Rating plate</b></p> <p>The rating plate is located on the side of the device.</p>
---	--

### 1.3.4 Abbreviations

Abbreviation	Explanation
A/D	Analog/Digital
C	Calibration factor for calculating the pressure for gases other than air
COM	Common contact
F.S.	Full scale (end value)
NC	Normally closed contact
MSL	Mean sea level

Abbreviation	Explanation
NO	Normally open contact
PE	Penning
PTC	Temperature-dependent resistor (positive temperature coefficient)
SP	Setpoint (switch-point)
UART	Universal asynchronous receiver transmitter (electronic switching to establish digital serial interfaces)

**Tbl. 3: Abbreviations used**

## 1.4 Trademark proof

- Windows® and Internet Explorer® are trademarks of Microsoft Corporation.
- Binder® is a trademark of Franz Binder GmbH + Co. Elektrische Bauelemente KG.

## 2 Safety

### 2.1 General safety information

The following 4 risk levels and 1 information level are taken into account in this document.

#### **DANGER**

##### **Immediately pending danger**

Indicates an immediately pending danger that will result in death or serious injury if not observed.

- ▶ Instructions to avoid the danger situation

#### **WARNING**

##### **Potential pending danger**

Indicates a pending danger that could result in death or serious injury if not observed.

- ▶ Instructions to avoid the danger situation

#### **CAUTION**

##### **Potential pending danger**

Indicates a pending danger that could result in minor injuries if not observed.

- ▶ Instructions to avoid the danger situation

#### **NOTICE**

##### **Danger of damage to property**

Is used to highlight actions that are not associated with personal injury.

- ▶ Instructions to avoid damage to property



Notes, tips or examples indicate important information about the product or about this document.

### 2.2 Safety instructions



#### **Safety instructions according to product life stages**

All safety instructions in this document are based on the results of a risk assessment. Pfeiffer Vacuum has taken into account all the relevant life stages of the product.

Risks during installation



**⚠ DANGER**

**Danger to life due to electric voltage**

High voltages are present inside the device. When touching parts that are live, there is a risk of death. If there is visible damage, there is a risk of death when commissioning the device.

- ▶ Work on the open device must only be carried out by trained specialist personnel.
- ▶ Before carrying out any installation and maintenance work, switch the device off and disconnect it from the current supply.
  - After switching off, wait about 60 seconds and then disconnect all cables (power cable at the end).
- ▶ Never open the device with the current supply connected.
- ▶ Secure the current supply against unauthorized or unintentional reactivation.
- ▶ Do not insert any objects into the vent openings.
- ▶ Never open an external power supply pack.
- ▶ Never operate an open or defective device.
- ▶ Secure a defective device against accidental operation.
- ▶ Protect the device against moisture.

**⚠ DANGER**

**Danger to life from electric shock**

The internal earthed conductor is fastened to the housing by a screw. A device without an earthed conductor attached can be life-threatening in the event of a malfunction.

- ▶ Do not rotate or loosen the screw on the internal earthed conductor.

**⚠ DANGER**

**Danger to life due to dangerous contact voltage**

Voltages above 30 V (AC) or 60 V (DC) are considered dangerous in accordance with IEC 61010. If you come into contact with dangerous contact voltage, this can result in injury through electric shocks or even death.

- ▶ Only apply protected extra-low voltage (PELV).

**⚠ DANGER**

**Danger to life from electric shock**

Inadequate or incorrect grounding of the unit leads to contact-sensitive voltage on the housing. When making contact, increased leakage currents will cause a life-threatening electric shock.

- ▶ Before the installation, check that the connection leads are voltage-free.
- ▶ Conduct the electrical connection in accordance with locally applicable regulations.
- ▶ Make sure that the local mains voltage and frequency match rating plate specifications.
- ▶ Make sure that the mains cable and extension cable meet the requirements for double isolation between input voltage and output voltage, in accordance with IEC 61010 and IEC 60950.
- ▶ Use only a 3-pin mains cable and extension cable with properly connected protective earthing (earthed conductor).
- ▶ Plug the mains plug into a socket with earthing contact only.
- ▶ Always connect the mains cable prior to all other cables, to ensure continuous protective earthing.

## Risks during operation

**⚠ DANGER****Danger to life due to electric voltage**

High voltages are present inside the device. When touching parts that are live, there is a risk of death. If there is visible damage, there is a risk of death when commissioning the device.

- ▶ Work on the open device must only be carried out by trained specialist personnel.
- ▶ Before carrying out any installation and maintenance work, switch the device off and disconnect it from the current supply.
  - After switching off, wait about 60 seconds and then disconnect all cables (power cable at the end).
- ▶ Never open the device with the current supply connected.
- ▶ Secure the current supply against unauthorized or unintentional reactivation.
- ▶ Do not insert any objects into the vent openings.
- ▶ Never open an external power supply pack.
- ▶ Never operate an open or defective device.
- ▶ Secure a defective device against accidental operation.
- ▶ Protect the device against moisture.

**⚠ DANGER****Electric shock due to moisture entering the unit**

Water that has entered the unit will result in personal injury through electric shocks.

- ▶ Only operate the unit in a dry environment.
- ▶ Operate the unit away from fluids and sources of moisture.
- ▶ Do not switch on the unit if fluid has entered it. Instead contact Pfeiffer Vacuum Service.
- ▶ Always disconnect the power supply before cleaning the unit.

## Risks during maintenance

**⚠ DANGER****Danger to life due to electric voltage**

High voltages are present inside the device. When touching parts that are live, there is a risk of death. If there is visible damage, there is a risk of death when commissioning the device.

- ▶ Work on the open device must only be carried out by trained specialist personnel.
- ▶ Before carrying out any installation and maintenance work, switch the device off and disconnect it from the current supply.
  - After switching off, wait about 60 seconds and then disconnect all cables (power cable at the end).
- ▶ Never open the device with the current supply connected.
- ▶ Secure the current supply against unauthorized or unintentional reactivation.
- ▶ Do not insert any objects into the vent openings.
- ▶ Never open an external power supply pack.
- ▶ Never operate an open or defective device.
- ▶ Secure a defective device against accidental operation.
- ▶ Protect the device against moisture.

**⚠ WARNING****Health hazard through poisoning from toxic contaminated components or devices**

Toxic process media result in contamination of devices or parts of them. During maintenance work, there is a risk to health from contact with these poisonous substances. Illegal disposal of toxic substances causes environmental damage.

- ▶ Take suitable safety precautions and prevent health hazards or environmental pollution by toxic process media.
- ▶ Decontaminate affected parts before carrying out maintenance work.
- ▶ Wear protective equipment.

**⚠ WARNING**

**Health hazards due to cleaning agent**

The cleaning agent being used causes health hazards which could include, for example, poisoning, allergies, skin irritations, chemical burns or damage to the airways.

- ▶ When handling cleaning agents, observe the applicable regulations.
- ▶ Adhere to safety measures regarding handling and disposal of cleaning agents.
- ▶ Be aware of potential reactions with product materials.

**Risks when shipping**

**⚠ WARNING**

**Risk of poisoning from contaminated products**

Where products that contain harmful substances are shipped for maintenance or repair purposes, the health and safety of service personnel is at risk.

- ▶ Comply with the instructions for safe distribution.

**Risks during disposal**

**⚠ WARNING**

**Health hazard through poisoning from toxic contaminated components or devices**

Toxic process media result in contamination of devices or parts of them. During maintenance work, there is a risk to health from contact with these poisonous substances. Illegal disposal of toxic substances causes environmental damage.

- ▶ Take suitable safety precautions and prevent health hazards or environmental pollution by toxic process media.
- ▶ Decontaminate affected parts before carrying out maintenance work.
- ▶ Wear protective equipment.

## 2.3 Safety precautions

The product is designed according to the latest technology and recognized safety engineering rules. Nevertheless, improper use can result in danger to operator all third party life and limb, and product damage and additional property damage.



**Duty to provide information on potential dangers**

The product holder or user is obliged to make all operating personnel aware of dangers posed by this product.

Every person who is involved in the installation, operation or maintenance of the product must read, understand and adhere to the safety-related parts of this document.



**Infringement of conformity due to modifications to the product**

The Declaration of Conformity from the manufacturer is no longer valid if the operator changes the original product or installs additional equipment.

- Following the installation into a system, the operator is required to check and re-evaluate the conformity of the overall system in the context of the relevant European Directives, before commissioning that system.

**General safety precautions when handling the product**

- ▶ Observe all applicable safety and accident prevention regulations.
- ▶ Check that all safety measures are observed at regular intervals.
- ▶ Pass on safety instructions to all other users.
- ▶ Make sure that the user can clearly recognize the disconnect device and can easily reach it.
- ▶ Always ensure a secure connection to the earthed conductor (PE).
- ▶ Never disconnect plug connections during operation.
- ▶ Observe the above shutdown procedures.
- ▶ Keep lines and cables away from hot surfaces (> 70°C).

- ▶ Do not carry out your own conversions or modifications on the unit.
- ▶ Observe the unit protection degree prior to installation or operation in other environments.
- ▶ Provide suitable touch protection, if the surface temperature exceeds 70°C.
- ▶ Inform yourself about any contamination before starting work.

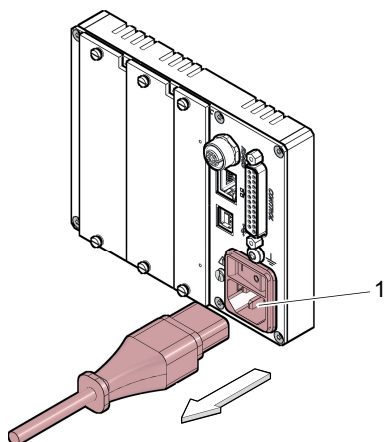

**Fig. 1: Disconnect device in accordance with EN 61010-1**

1 Disconnect device

## 2.4 Proper use

In conjunction with Pfeiffer Vacuum ModulLine gauges, the total pressure measuring and control unit is used to measure the total pressure of atmospheric pressure up to  $10^{-11}$  hPa, depending on the respective configuration. Moreover, the total pressure measuring and control unit fulfills a whole range of tasks for the control and monitoring of vacuum equipment and processes by means of pressure-dependent switching functions.

- ▶ Install, operate and maintain the product only in accordance with these operating instructions.
- ▶ Comply with the limits of use.
- ▶ Observe the technical data.

## 2.5 Foreseeable improper use

Improper use of the product invalidates all warranty and liability claims. Any use that is counter to the purpose of the product, whether intentional or unintentional, is regarded as improper use; in particular:

- Use outside the mechanical and electrical application limits in accordance with the technical data
- Use with corrosive or explosive media, if this is not explicitly permitted
- Use outdoors
- Use after technical changes (on the inside or the outside of the product)
- Use with replacement or accessory parts that are unsuitable or are not approved

## 2.6 Responsibilities and warranty

Pfeiffer Vacuum shall assume no responsibilities and warranty if the operating company or a third party:

- disregards this document
- does not use the product for its intended purpose
- carries out any modifications to the product (conversions, changes, etc.) that are not listed in the corresponding product documentation
- operates the product with accessories that are not listed in the corresponding product documentation

The operator is responsible for the process media used.

## 2.7 Owner requirements

### Safety-conscious working

1. Only operate the product in a technically flawless state.
2. Operate the product in line with its intended purpose, safety and hazard-conscious and only in compliance with these operating instructions.
3. Fulfill the following instructions and monitor the observation of the following instructions:
  - Proper use
  - Generally applicable safety instructions and accident prevention regulations
  - International, national and locally applicable standards and guidelines
  - Additional product-related guidelines and regulations
4. Only use original parts or parts approved by Pfeiffer Vacuum.
5. Keep the operating instructions available at the place of installation.
6. Ensure personnel qualification.

## 2.8 Personnel qualification

The work described in this document may only be carried out by persons who have appropriate professional qualifications and the necessary experience or who have completed the necessary training as provided by Pfeiffer Vacuum.

### Training people

1. Train the technical personnel on the product.
2. Only let personnel to be trained work with and on the product when under the supervision of trained personnel.
3. Only allow trained technical personnel to work with the product.
4. Before starting work, make sure that the commissioned personnel have read and understood these operating instructions and all applicable documents, in particular the safety, maintenance and repair information.

### 2.8.1 Ensuring personnel qualification

#### Specialist for mechanical work

Only a trained specialist may carry out mechanical work. Within the meaning of this document, specialists are people responsible for construction, mechanical installation, troubleshooting and maintenance of the product, and who have the following qualifications:

- Qualification in the mechanical field in accordance with nationally applicable regulations
- Knowledge of this documentation

#### Specialist for electrotechnical work

Only a trained electrician may carry out electrical engineering work. Within the meaning of this document, electricians are people responsible for electrical installation, commissioning, troubleshooting, and maintenance of the product, and who have the following qualifications:

- Qualification in the electrical engineering field in accordance with nationally applicable regulations
- Knowledge of this documentation

In addition, these individuals must be familiar with applicable safety regulations and laws, as well as the other standards, guidelines, and laws referred to in this documentation. The above individuals must have an explicitly granted operational authorization to commission, program, configure, mark, and earth devices, systems, and circuits in accordance with safety technology standards.

#### Trained individuals

Only adequately trained individuals may carry out all works in other transport, storage, operation and disposal fields. Such training must ensure that individuals are capable of carrying out the required activities and work steps safely and properly.

### 2.8.2 Personnel qualification for maintenance and repair



#### Advanced training courses

Pfeiffer Vacuum offers advanced training courses to maintenance levels 2 and 3.



Adequately trained individuals are:

- **Maintenance level 1**
  - Customer (trained specialist)
- **Maintenance level 2**
  - Customer with technical education
  - Pfeiffer Vacuum service technician
- **Maintenance level 3**
  - Customer with Pfeiffer Vacuum service training
  - Pfeiffer Vacuum service technician

### 2.8.3 Advanced training with Pfeiffer Vacuum

For optimal and trouble-free use of this product, Pfeiffer Vacuum offers a comprehensive range of courses and technical trainings.

For more information, please contact [Pfeiffer Vacuum technical training](#).

## 2.9 Operator requirements

### Observing relevant documents and data

1. Read, observe and follow this operating instruction and the work instructions prepared by the operating company, in particular the safety and warning instructions.
2. Install, operate and maintain the product only in accordance with these operating instructions.
3. Carry out all work only on the basis of the complete operating instructions and applicable documents.
4. Comply with the application limits.
5. Observe the technical data.
6. Please contact the Pfeiffer Vacuum Service Center if your questions on operation or maintenance of the product are not answered in these operating instructions.
  - You can find information in the [Pfeiffer Vacuum service area](#).

## 3 Product description

### 3.1 Structure

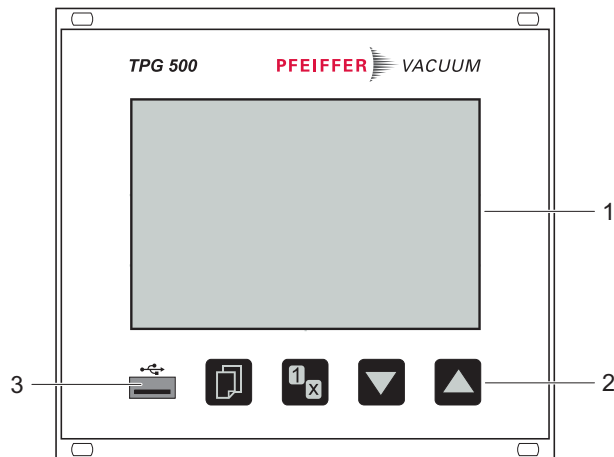

**Fig. 2: Front panel**

- 1 Display
- 2 Controls
- 3 USB connection (type A)

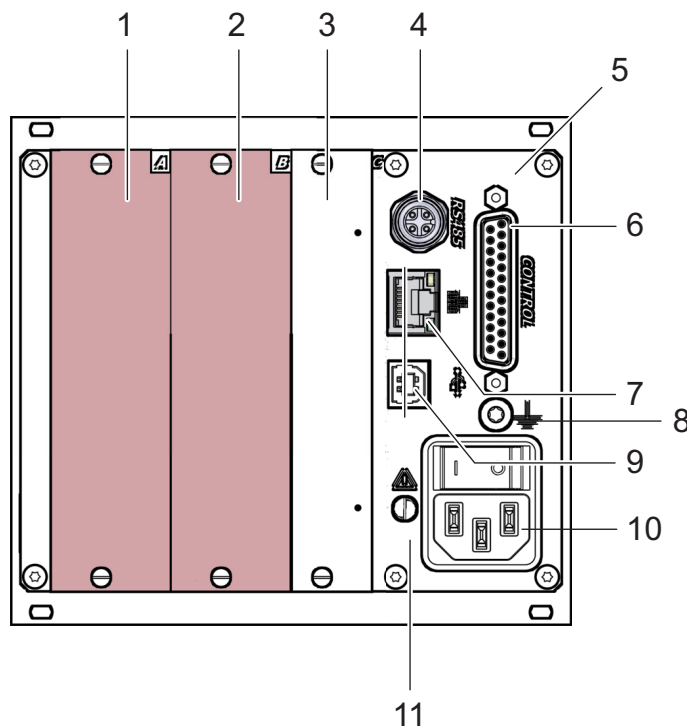

**Fig. 3: Connections on the rear side**

- 1 Plug-in position A for a measuring board
- 2 Plug-in position B for a measuring board
- 3 Plug-in position C for an interface board and relay board
- 4 "RS 485" connection as a serial interface
- 5 Power supply pack
- 6 "CONTROL" connection for control functions
- 7 Ethernet interface
- 8 Ground terminal
- 9 USB connection (type B)
- 10 Mains connection socket with mains switch
- 11 Internal earthed conductor

## 3.2 Display elements



### Display text in this manual

Both lines of the display text are separated in this manual by a vertical dash (Line 1 | Line 2).

### Display elements of the device

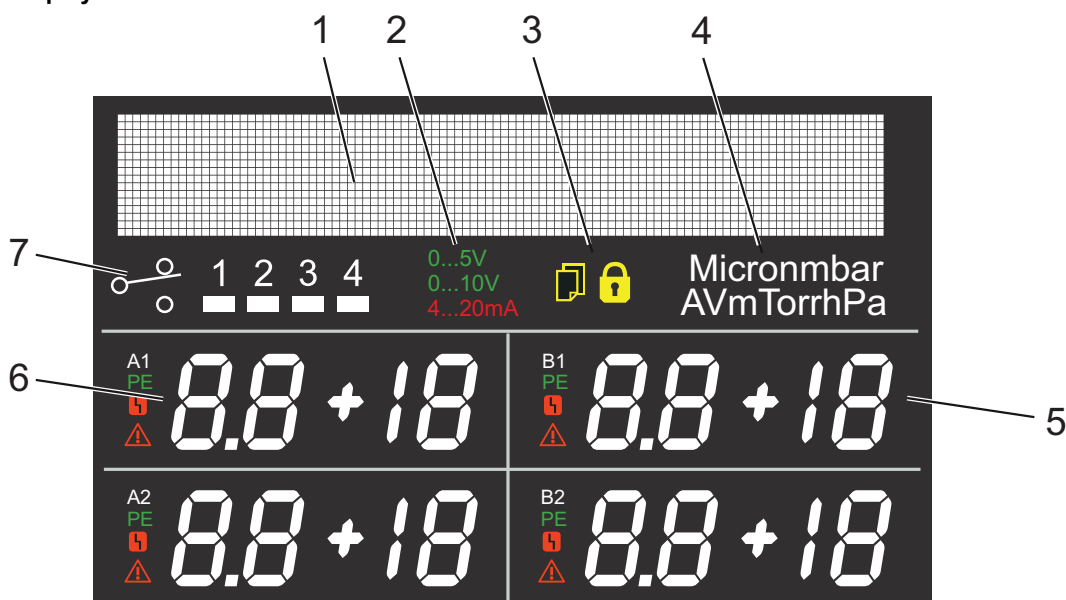

Fig. 4: Display elements of the device

- |   |                                     |   |  |
|---|-------------------------------------|---|--|
| 1 | Parameter or bar graph              | 5 | Measuring channel status (measuring channel B1 and B2) |
| 2 | Configuration of the analog outputs | 6 | Measuring channel status (measuring channel A1 and A2) |
| 3 | Parameter mode or input lock        | 7 | Switch-points  |
| 4 | Unit of measurement                 |   |  |

### Parameter or bar graph



Fig. 5: Parameter or bar graph

- |   |                            |   |  |
|---|----------------------------|---|--|
| 1 | Parameter display (line 1) | 3 | Bar graph with switching point.<br>The symbol for the corresponding measuring channel starts flashing. |
| 2 | Parameter display (line 2) | 4 | Pressure vs. time, trend.<br>The symbol for the corresponding measuring channel starts flashing.       |

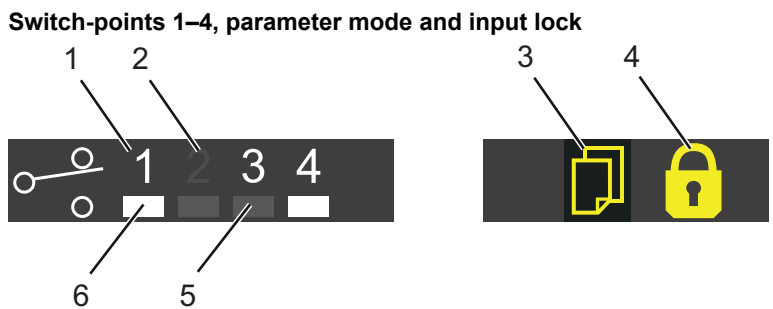

Fig. 6: Switch-points 1–4, parameter mode and input lock

- |   |   |   |                                      |
|---|---|---|--------------------------------------|
| 1 | Switching function activated (number lights up)           | 4 | Input lock activated                 |
| 2 | Switching function deactivated (number does not light up) | 5 | Relay off (symbol does not light up) |
| 3 | Parameter mode activated                                  | 6 | Relay on (symbol lights up)          |

Measurement channel status

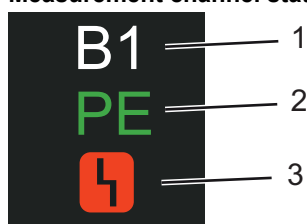

Fig. 7: Measurement channel status

- |   |  |   |       |
|---|--|---|-------|
| 1 | Measurement channel  | 3 | Error |
| 2 | Operating mode display for cold cathode gauges in the HV-range |   |       |

### 3.3 Controls

Key	Designation	Functions (depending on operating mode)
	Parameter	<ul style="list-style-type: none"> <li>Change to parameter mode</li> <li>Select parameter/group</li> <li>Save changes and return to read mode</li> </ul>
	Measurement channel	Change measurement channel
	UP and DOWN arrow keys	<ul style="list-style-type: none"> <li>Select parameter</li> <li><b>Press for &lt; 1 second:</b> Increase/reduce/change value by increments</li> <li><b>Press for &gt; 1 second:</b> Increase/reduce/change value continually</li> </ul>

Tbl. 4: Controls

## 3.4 Interfaces

### 3.4.1 Mains connection

#### **⚠ DANGER**

##### **Danger to life from electric shock**

Inadequate or incorrect grounding of the unit leads to contact-sensitive voltage on the housing. When making contact, increased leakage currents will cause a life-threatening electric shock.

- ▶ Before the installation, check that the connection leads are voltage-free.
- ▶ Conduct the electrical connection in accordance with locally applicable regulations.
- ▶ Make sure that the local mains voltage and frequency match rating plate specifications.
- ▶ Make sure that the mains cable and extension cable meet the requirements for double isolation between input voltage and output voltage, in accordance with IEC 61010 and IEC 60950.
- ▶ Use only a 3-pin mains cable and extension cable with properly connected protective earthing (earthed conductor).
- ▶ Plug the mains plug into a socket with earthing contact only.
- ▶ Always connect the mains cable prior to all other cables, to ensure continuous protective earthing.

The mains connection with mains switch is located on the rear side of the device. A mains cable is included in the shipment. **The socket requires a 10 A<sub>max</sub> fuse.**

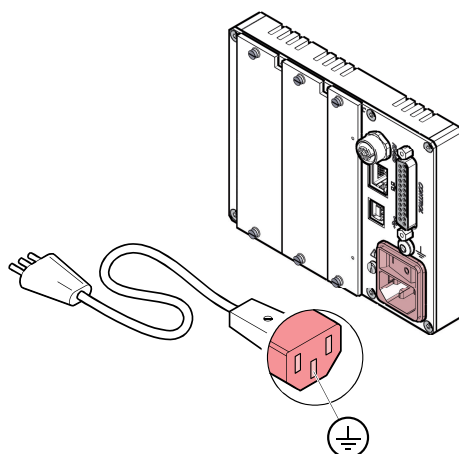

Fig. 8: Mains connection with main switch and IEC 320 C13 socket

### 3.4.2 Ground terminal

The connection to the protective earthing is located on the rear side of the device.

### 3.4.3 "CONTROL" connection

#### **⚠ DANGER**

##### **Danger to life due to dangerous contact voltage**

Voltages above 30 V (AC) or 60 V (DC) are considered dangerous in accordance with IEC 61010. If you come into contact with dangerous contact voltage, this can result in injury through electric shocks or even death.

- ▶ Only apply protected extra-low voltage (PELV).

The connection offers the following functions:

- Analog reading of measurement signal
- Use of switching functions
- Zero potential evaluation of malfunction monitoring system status

To connect peripheral components, you need a self-made, screened connection cable (EMC).

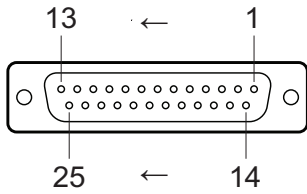

**Fig. 9: "CONTROL" connection (25-pole D-Sub socket)**

17	Ground (GND)	25	Analog output 4
18	Analog ground to analog output 1	9	+24 V (DC), 100 mA <sup>1)</sup>
19	Analog output 1	7, 8, 16	Switching function 1
20	Analog ground to analog output 2	4, 5, 13	Switching function 2
21	Analog output 2	1, 2, 10	Switching function 3
22	Analog ground to analog output 3	6, 14, 15	Switching function 4
23	Analog output 3	3, 11, 12	Error signal (error)
24	Analog ground to analog output 4		

Pins	Switching function	Description	Switching function	Description
8 5 2 15		Pressure higher than threshold value or device switched off		Pressure lower than threshold value
16 13 10 6				
7 4 1 14				
12		Error or device switched off		No errors
3				
11				

**Tbl. 5: Switching functions**

### 3.4.4 "RS-485" connector

The "RS-485" connection enables operation of the device using a computer or terminal. The use of a Y-distributor permits the integration into a bus system. For connecting the serial interface, you need a screened cable (EMC).

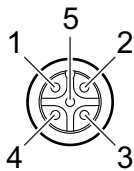

**Fig. 10: "RS-485" connection (5-pin Binder M12 socket)**

1	RS-485+ (differential)	4	RS-485- (differential)
2	+24 V (DC), ≤ 200 mA	5	unassigned
3	Ground (GND)		

### 3.4.5 "USB" connection (type A)

The "USB" connection (type A) with master functionality is located on the front side and is used to connect a USB storage medium (e.g. firmware update, parameter storage (reading/writing), data logger).

1) Supply for relays with higher switching power. Fused at 100 mA with PTC element, self-resetting after switching off the device or unplugging the "CONTROL" plug. Meets the requirements of protected extra-low voltage (PELV).

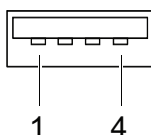
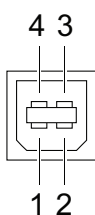

**Fig. 11: "USB" connection (type A)**

- |   |            |   |              |
|---|------------|---|--------------|
| 1 | VBUS (5 V) | 3 | D+           |
| 2 | D-         | 4 | Ground (GND) |

### 3.4.6 "USB" connection (type B)

The "USB" connection (type B) enables direct communication with the device via a computer (e.g. firmware updates, storing parameters (reading/writing)). For the connection, you need a screened cable (EMC). If a virtual serial interface (COM) is not set up automatically, you need the driver from [FTDI Chip \(Virtual COM Port Drivers\)](#).

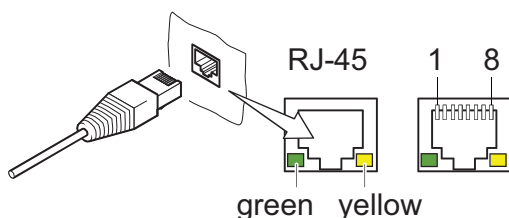

**Fig. 12: "USB" connection (type B)**

- |   |            |   |              |
|---|------------|---|--------------|
| 1 | VBUS (5 V) | 3 | D+           |
| 2 | D-         | 4 | Ground (GND) |

### 3.4.7 "Ethernet" (LAN) connection

The "Ethernet" connection enables direct communication with the device via a computer.



**Fig. 13: "Ethernet" (LAN) connection**

- |   |                         |            |                      |
|---|-------------------------|------------|----------------------|
| 1 | Transmission data (TD+) | 6          | Reception data (RD-) |
| 2 | Transmission data (TD-) | 4, 5, 7, 8 | Not used             |
| 3 | Reception data (RD+)    |            |                      |

LED	Status	Meaning
Green (link)	lights up	Hardware connection exists
	dark	No hardware connection
Yellow (activity)	lit up (flickering)	Data transmission runs
	dark	no data transmission / no connection

**Tbl. 6: Status of the Ethernet connection**

## 3.5 Identifying the product

You will need all the data from the rating plate to safely identify the product when communicating with Pfeiffer Vacuum.

1. Read the data on the product rating plate.
2. Record this data.
3. Always have all rating plate specifications to hand.

### 3.6 Scope of delivery

- Total pressure measuring and control unit
- Dummy plates <sup>2)</sup>
  - 2 dummy plates for measuring board slots
  - 1 dummy plate for interface board slots
- Accessory kit
  - 4 × collar screws and synthetic nipple
  - 1 rubber strip
  - 2 self-adhesive rubber feet
  - 4 banana plugs, 2 mm, red
  - 4 banana plugs, 2 mm, black
  - 1 screwdriver, 2 mm
- Installation instructions
- Operating instructions

#### **Unpacking the product and checking completeness of the shipment**

1. Unpack the product.
2. Remove the transport fasteners, transport protection etc.
3. Store the transport fasteners, transport protection etc. in a safe place.
4. Check that the shipment is complete.
5. Ensure that no parts are damaged.

---

2) Installed at free slots, or included in scope of supply, depending on the configuration



## 4 Transport and storage

### 4.1 Transporting the product

#### NOTICE

##### Damage caused by incorrect transport

Transport in unsuitable packaging or failure to install all transport locks can result in damage to the product.

- ▶ Comply with the instructions for safe transport.



##### Packing

We recommend keeping the transport packaging and original protective cover.

##### Transport product safely

- ▶ Observe the weight specified on the transport packaging.
- ▶ Where possible, always transport or ship the product in the original transport packaging.
- ▶ Always use dense and impact-proof transport packaging for the product.
- ▶ Remove the existing protective cover and transport protections only immediately prior to installation.
- ▶ Reattach transport locks and transport protections prior to each transport.

### 4.2 Storing the product

#### NOTICE

##### Damage caused by improper storage

Improper storage will lead to damage to the product.

Static charging, moisture, etc. will lead to defects on the electronic components.

- ▶ Comply with the instructions for safe storage.



##### Packing

We recommend storing the product in its original packaging.

##### Store product safely

- ▶ Store the product in a cool, dry, dust-free place, where it is protected against impacts and mechanical vibration.
- ▶ Always use dense and impact-proof packaging for the product.
- ▶ Where possible, store the product in its original packaging.
- ▶ Store electronic components in antistatic packaging.
- ▶ Maintain the permissible storage temperature.
- ▶ Avoid extreme fluctuations of the ambient temperature.
- ▶ Avoid high air humidity.
- ▶ Seal connections with the original protective caps.
- ▶ Protect the product with the original transport protection (where available).

## 5 Installation

### Observe the ambient conditions

- ▶ Install and operate the unit within the permissible ambient conditions.

### 5.1 Installing device in a 19" rack

#### NOTICE

##### Damage caused by overheating

The ambient temperature must not exceed the permissible operating temperature of the device.

- ▶ Make sure there is unobstructed circulation of air when installing the device.
- ▶ Periodically check and clean the installed air filter, if necessary.

#### NOTICE

##### Loss of control cabinet protection class

As a built-in unit, the device can negate the required protection class (protection against foreign matter and water) of control cabinets according to IEC 60204-1, for example.

- ▶ Take suitable measures to reestablish the required protection class.

#### Required tools

- Screwdriver

#### Required material

- 4 × collar screws and synthetic nipple
- Slide rails (optional)

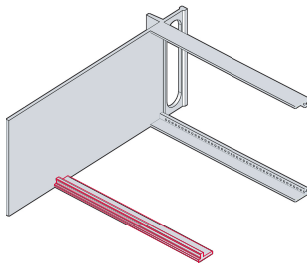

Fig. 14: Guide rail

#### Installing guide rails

- ▶ Install a guide rail on the rack module adapter to relieve the load on the front panel of the device.

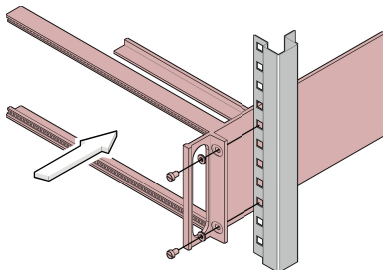
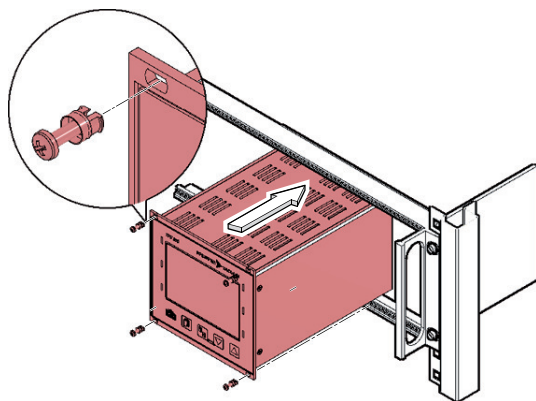

Fig. 15: 19" rack module adapter as per DIN 41 494 (height 3)

#### Fastening the rack module adapter

- ▶ Fasten the rack module adapter in the rack cabinet.



**Fig. 16: Device installation**

#### Installing device in the rack module adapter

1. Recommendation: Install the slide rails in the rack frame for safe and easy installation of heavy rack module adapters.
2. Push the device into the rack module adapter.
3. Fasten the device using the screws included in the shipment.

## 5.2 Installing device in a switchboard

### NOTICE

#### Damage caused by overheating

The ambient temperature must not exceed the permissible operating temperature of the device.

- ▶ Make sure there is unobstructed circulation of air when installing the device.
- ▶ Periodically check and clean the installed air filter, if necessary.

### NOTICE

#### Loss of control cabinet protection class

As a built-in unit, the device can negate the required protection class (protection against foreign matter and water) of control cabinets according to IEC 60204-1, for example.

- ▶ Take suitable measures to reestablish the required protection class.

#### Required tools

- Screwdriver

#### Required material

- 4 screws (M3 or equivalent)

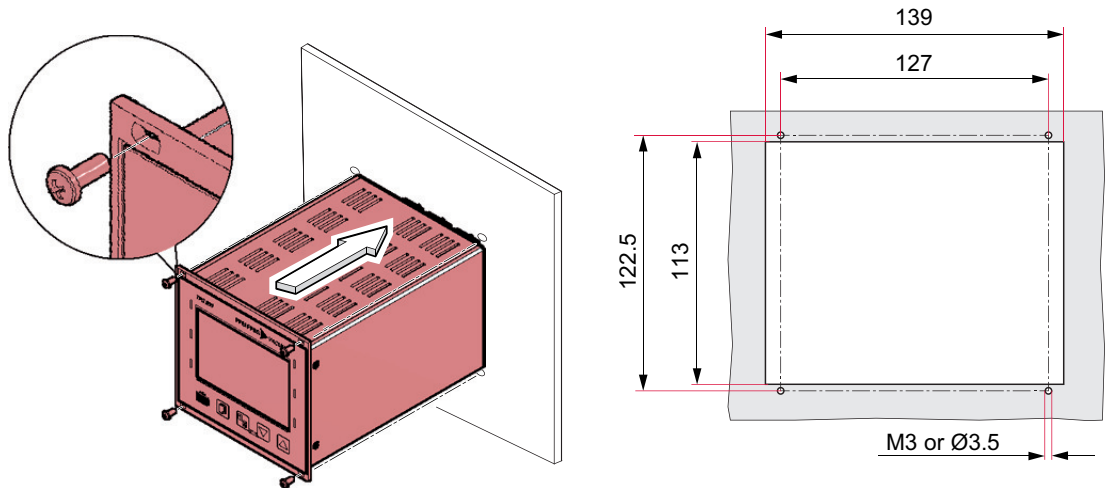

**Fig. 17: Required switchboard cut-out**

**Procedure**

1. Support the device from below to relieve the front panel.
2. Push the device into the switchboard cut-out.
3. Fasten the device using 4 screws.

### 5.3 Using device as a desktop device

**NOTICE**

**Damage caused by overheating**

The ambient temperature must not exceed the permissible operating temperature of the device.

- ▶ Make sure there is unobstructed circulation of air when installing the device.
- ▶ Periodically check and clean the installed air filter, if necessary.

**Required materials**

- 2 self-adhesive rubber feet
- 1 attachable rubber strip

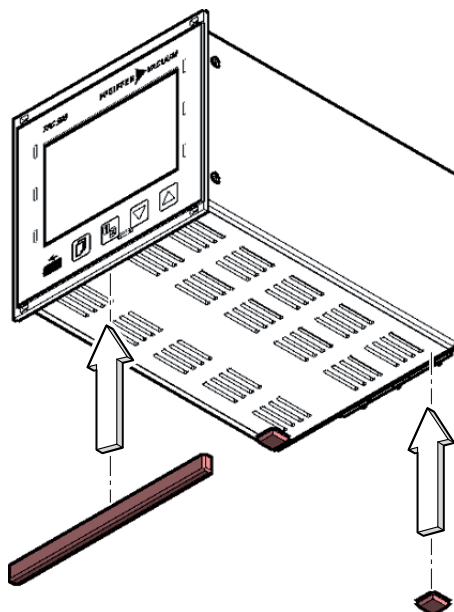

**Fig. 18: Fasten the rubber feet and rubber strip**

**Procedure**

1. Stick the 2 rubber feet at the rear side on the housing base.
2. Stick the rubber strip on the front panel from underneath.

## 5.4 Establishing a grounding connection

### DANGER

#### Danger to life from electric shock

The internal earthed conductor is fastened to the housing by a screw. A device without an earthed conductor attached can be life-threatening in the event of a malfunction.

- ▶ Do not rotate or loosen the screw on the internal earthed conductor.

**Procedure**

- ▶ Connect the device via an earthed conductor (e.g. the protective earth of the pumping station), if necessary using the protective earth screw.

## 5.5 Connecting to mains power supply



### DANGER

#### Danger to life due to electric voltage

High voltages are present inside the device. When touching parts that are live, there is a risk of death. If there is visible damage, there is a risk of death when commissioning the device.

- ▶ Work on the open device must only be carried out by trained specialist personnel.
- ▶ Before carrying out any installation and maintenance work, switch the device off and disconnect it from the current supply.
  - After switching off, wait about 60 seconds and then disconnect all cables (power cable at the end).
- ▶ Never open the device with the current supply connected.
- ▶ Secure the current supply against unauthorized or unintentional reactivation.
- ▶ Do not insert any objects into the vent openings.
- ▶ Never open an external power supply pack.
- ▶ Never operate an open or defective device.
- ▶ Secure a defective device against accidental operation.
- ▶ Protect the device against moisture.

### DANGER

#### Danger to life from electric shock

Inadequate or incorrect grounding of the unit leads to contact-sensitive voltage on the housing. When making contact, increased leakage currents will cause a life-threatening electric shock.

- ▶ Before the installation, check that the connection leads are voltage-free.
- ▶ Conduct the electrical connection in accordance with locally applicable regulations.
- ▶ Make sure that the local mains voltage and frequency match rating plate specifications.
- ▶ Make sure that the mains cable and extension cable meet the requirements for double isolation between input voltage and output voltage, in accordance with IEC 61010 and IEC 60950.
- ▶ Use only a 3-pin mains cable and extension cable with properly connected protective earthing (earthed conductor).
- ▶ Plug the mains plug into a socket with earthing contact only.
- ▶ Always connect the mains cable prior to all other cables, to ensure continuous protective earthing.



#### Mains cable

A mains cable is not included in the scope of delivery.

**Prerequisite**

- Main switch switched off

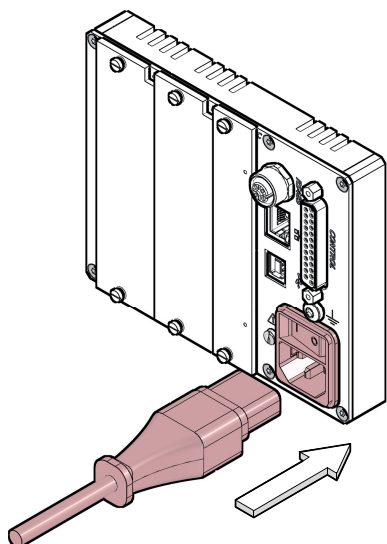

**Fig. 19: Connect the power supply cable**

**Connecting to the mains power supply**

- ▶ Recommendation: Route the mains voltage through a switched power distributor if the device is installed in a control cabinet.
- ▶ Use a suitable mains cable with earthed conductor ( $3 \times 1.5 \text{ mm}^2$ ) if the mains plug is not compatible with your system.

**Connecting the power supply cable**

1. Connect the mains cable to the mains connection socket of the unit.
2. Connect the plug on the mains cable into a suitable socket.

## 5.6 Fitting device with plug-in boards



**Installation and connections of plug-in boards**

In most cases, Pfeiffer Vacuum supplies the TPG 500 ready for operation with installed plug-in boards. The electric connections (gauges, analog signals, relay contacts, etc.) depend on the plug-in board configuration.

You can find information on installing or replacing plug-in boards and on the electric connections in the operating instructions with document number **BG 5972** for the plug-in boards. You can find this document in the [Pfeiffer Vacuum Download Center](#).

## 6 Commissioning

### 6.1 Switch on the device

#### Prerequisites

- Device is installed correctly
- Technical data has been observed

#### Procedure

- ▶ Switch on the device at the mains switch.
- ▶ **In the case of rack installation or switchboard installation:** Switch on the unit centrally using the switched mains distributor.
- The device performs a self test.
- The device activates the current parameters.
- The device switches on all measuring circuits with activated warm start, as well as the operational Pirani gauges.
- The device indicates the measuring point identifier.

### 6.2 Configuring Ethernet

#### Prerequisites

- Microsoft Windows 7, 8 or 10 operating system
- Administrator rights

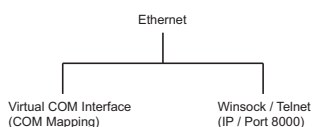

**Fig. 20:** Connection via virtual COM interface or via Winsock /Telnet

The Ethernet Configuration Tool offers the following functions:

- Configuration of the Ethernet interface via PC
- Assignment of a virtual serial interface (COM) to an IP address

The virtual COM interfaces can be accessed using any program that supports serial interfaces (e.g. terminal program, LabView, etc.). Depending on the protocol setting, communication with the device takes place either via the Mnemonic or Pfeiffer Vacuum protocol.

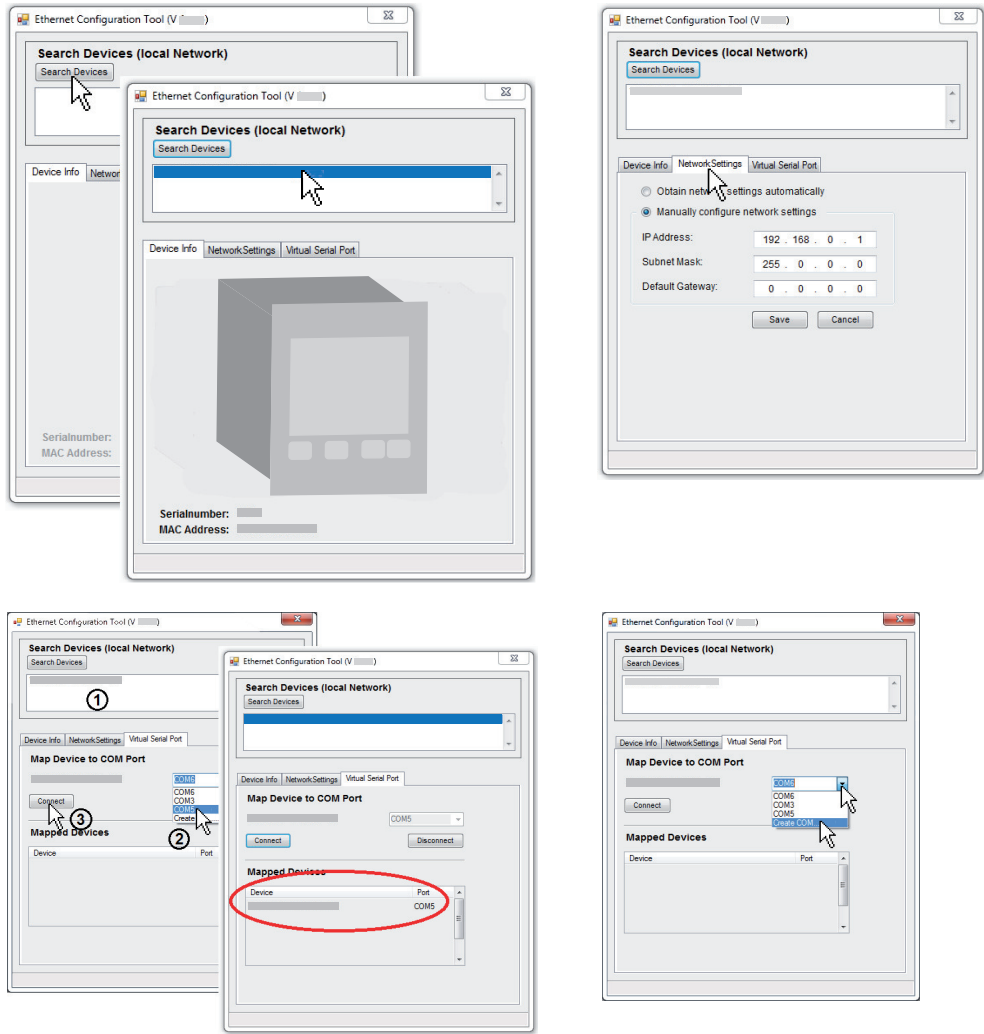

Fig. 21: Ethernet Configuration Tool

**Tabs of the Ethernet Configuration Tool**

- The "Device Info" tab displays basic information about the selected device.
- The automatic or manual network setting is made in the "Network Settings" tab.
- On the "Virtual Serial Port" tab, you can assign a separate COM port to each device and/or generate a new COM port.



**Using Ethernet Configuration Tool**

1. Recommendation: Contact your network administrator before you start the configuration.
2. Recommendation: Update the operating system before you start the Ethernet configuration.
3. Open the Pfeiffer Vacuum [Download Center](#) in the browser.
4. Enter "Ethernet Configuration Tool" as the keyword.
  - The display lists the available software.
5. Download the file in the desired language.
6. Connect the device to the network using a screened Ethernet cable.
7. Start the Ethernet Configuration Tool.
8. Click on "Search Devices".
  - The tool searches the local network for connected devices and lists the devices it finds in the selection window.
9. Make the required settings in the program.

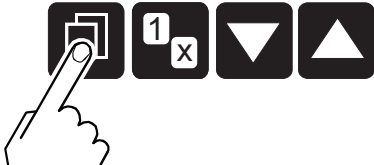
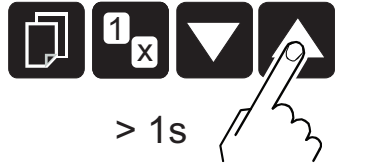

## 7 Operation

### 7.1 Using buttons

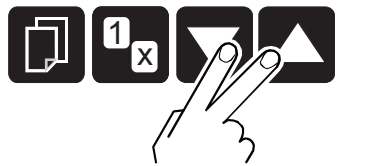
Operation	Description
	Press button
	Press button for longer than one second
	Do not press button
	Press buttons simultaneously

Tbl. 7: Functional principle of buttons

### 7.2 Converting measurement signal



**Diagrams and conversion formulas**

The diagrams and conversion formulas in this chapter only apply for the analog outputs at the "CONTROL" connection of the TPG 500.

### 7.2.1 Conversion for Pirani gauges

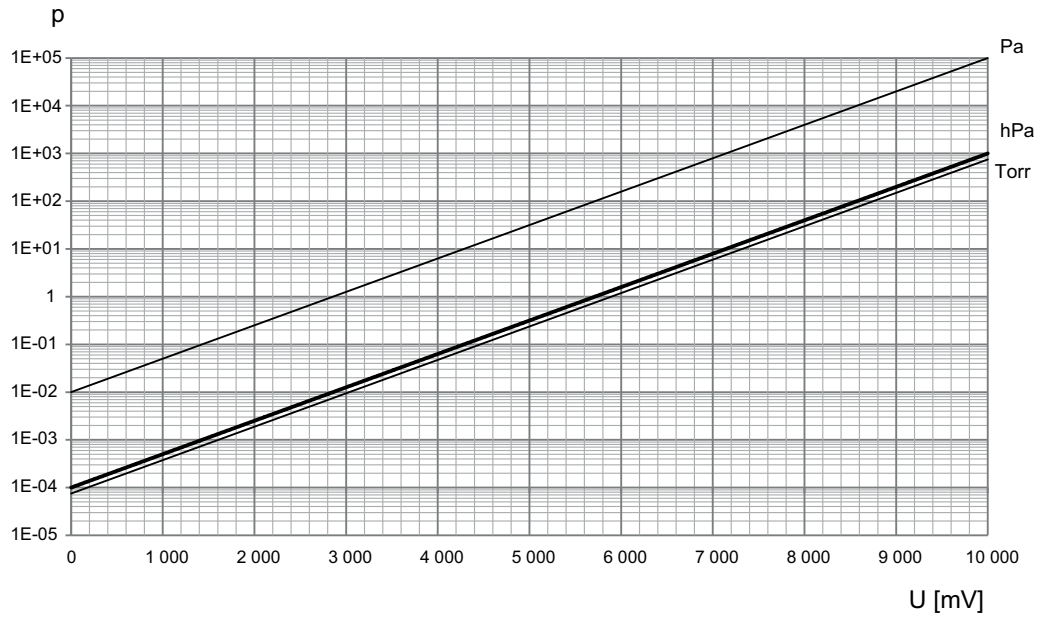

**Fig. 22: Relationship between output voltage and pressure for Pirani gauges**

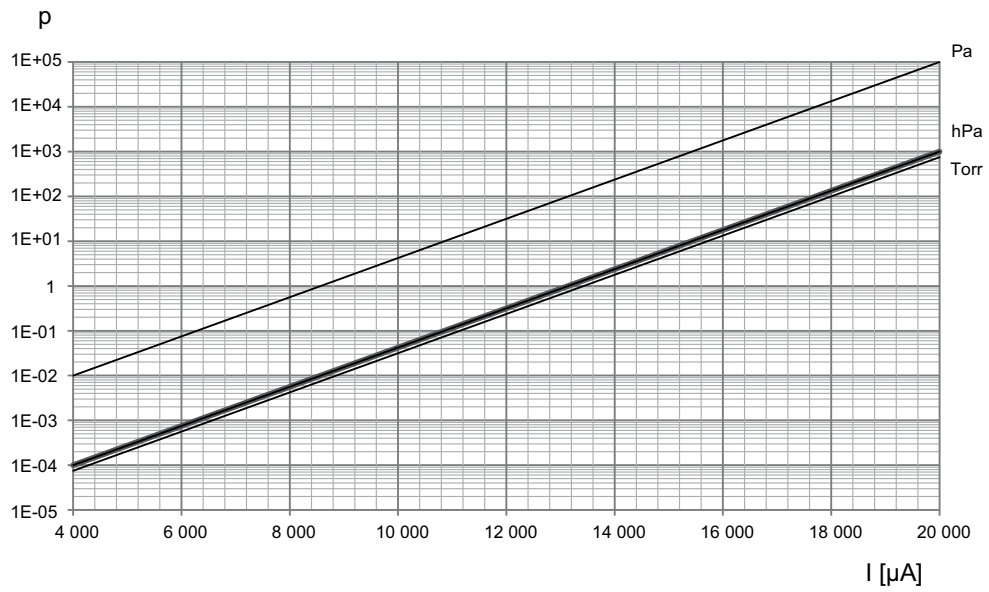

**Fig. 23: Relationship between output current and pressure for Pirani gauges**

**Converting measuring signal and pressure**

- ▶ Convert analog output voltage into pressure:  
 $p = c \times 10^{(0.7 \times U)}$
- ▶ Convert analog output current into pressure:  
 $p = d \times 10^{(7/16 \times I)}$
- ▶ Convert pressure into analog output voltage:  
 $U = 10/7 \times (\log p - \log c)$
- ▶ Convert pressure into analog output current:  
 $I = 16/7 \times (\log p - \log d)$
- ▶ Observe the constants for converting measuring signal and pressure.

**Validity range**

- $1 \times 10^{-4} \text{ hPa} < p < 1000 \text{ hPa}$
- $7.5 \times 10^{-5} \text{ Torr} < p < 750 \text{ Torr}$
- $1 \times 10^{-2} \text{ Pa} < p < 1 \times 10^5 \text{ Pa}$

Measurement signal (output voltage U)	Pressure (p)	Constant (c) <sup>3)</sup>
[V]	[hPa]	$1 \times 10^{-4}$
	[mbar]	
	[Pa]	0.01
	[kPa]	$1 \times 10^{-5}$
	[Torr]	$7.5 \times 10^{-5}$
	mTorr	0.075

**Tbl. 8:** Constant for converting output voltage and pressure for Pirani gauges

Measurement signal (output current I)	Pressure (p)	Constant (d) <sup>4)</sup>
[mA]	[hPa]	$1.778 \times 10^{-6}$
	[mbar]	
	[Pa]	$1.778 \times 10^{-4}$
	[kPa]	$1.778 \times 10^{-7}$
	[Torr]	$1.334 \times 10^{-6}$
	mTorr	$1.334 \times 10^{-3}$

**Tbl. 9:** Constant for converting output current and pressure for Pirani gauges

**7.2.2 Conversion for Penning gauges on measuring board CP 300 C9**

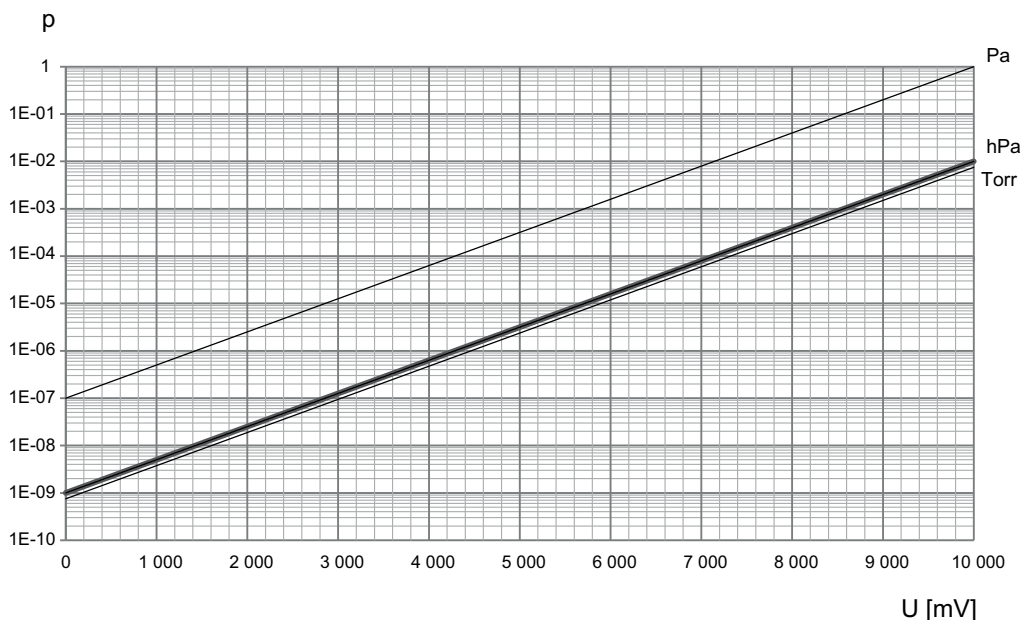

**Fig. 24:** Relationship between output voltage and pressure for Penning gauges on measuring board CP 300 C9

3) Dependent on unit of pressure  
 4) Dependent on unit of pressure

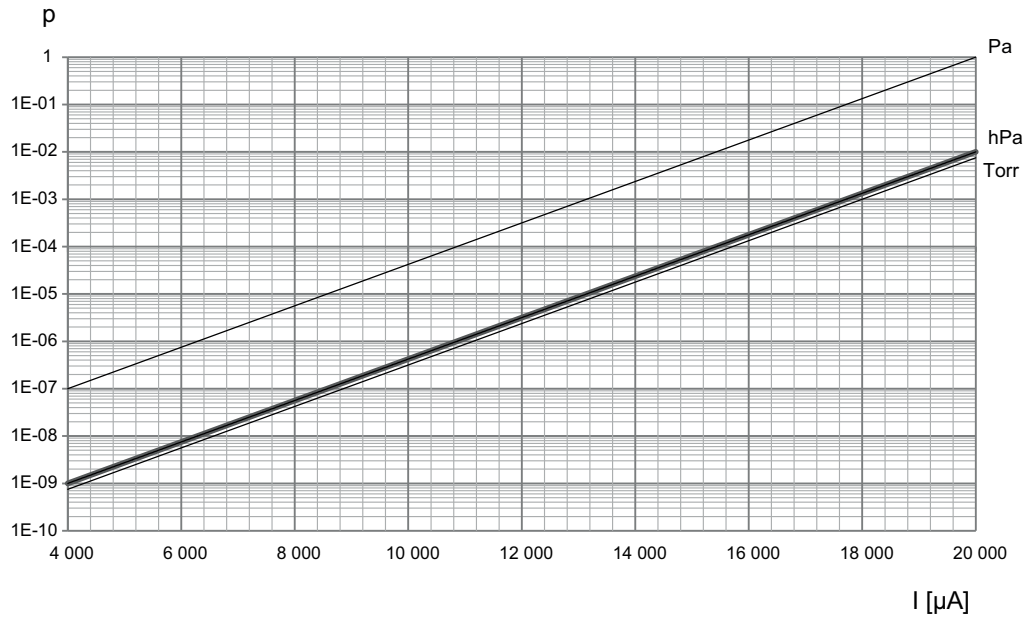

**Fig. 25: Relationship between output current and pressure for Penning gauges on measuring board CP 300 C9**

**Converting measuring signal and pressure**

- ▶ Convert analog output voltage into pressure:  
 $p = c \times 10^{(0.7 \times U)}$
- ▶ Convert analog output current into pressure:  
 $p = d \times 10^{(7/16 \times I)}$
- ▶ Convert pressure into analog output voltage:  
 $U = 10/7 \times (\log p - \log c)$
- ▶ Convert pressure into analog output current:  
 $I = 16/7 \times (\log p - \log d)$
- ▶ Observe the constants for converting measuring signal and pressure.

**Validity range**

- $1 \times 10^{-9} \text{ hPa} < p < 1 \times 10^{-2} \text{ hPa}$
- $7.5 \times 10^{-10} \text{ Torr} < p < 7.5 \times 10^{-3} \text{ Torr}$
- $1 \times 10^{-7} \text{ Pa} < p < 1 \text{ Pa}$

Measurement signal (output voltage U)	Pressure (p)	Constant (c) <sup>5)</sup>
[V]	[hPa]	$1 \times 10^{-9}$
	[mbar]	
	[Pa]	$1 \times 10^{-7}$
	[kPa]	$1 \times 10^{-10}$
	[Torr]	$7.5 \times 10^{-10}$
	mTorr	$7.5 \times 10^{-7}$

**Tbl. 10: Constant for converting output voltage and pressure for Penning gauges on measuring board CP 300 C9**

5) Dependent on unit of pressure

Measurement signal (output current I)	Pressure (p)	Constant (d) <sup>6)</sup>
[mA]	[hPa]	1.778 x 10 <sup>-11</sup>
	[mbar]	
	[Pa]	1.778 x 10 <sup>-9</sup>
	[kPa]	1.778 x 10 <sup>-12</sup>
	[Torr]	1.334 x 10 <sup>-11</sup>
	mTorr	1.334 x 10 <sup>-8</sup>

Tbl. 11: Constant for converting output current and pressure for Penning gauges on measuring board CP 300 C9

7.2.3 Conversion for Penning gauges on measuring board CP 300 C10

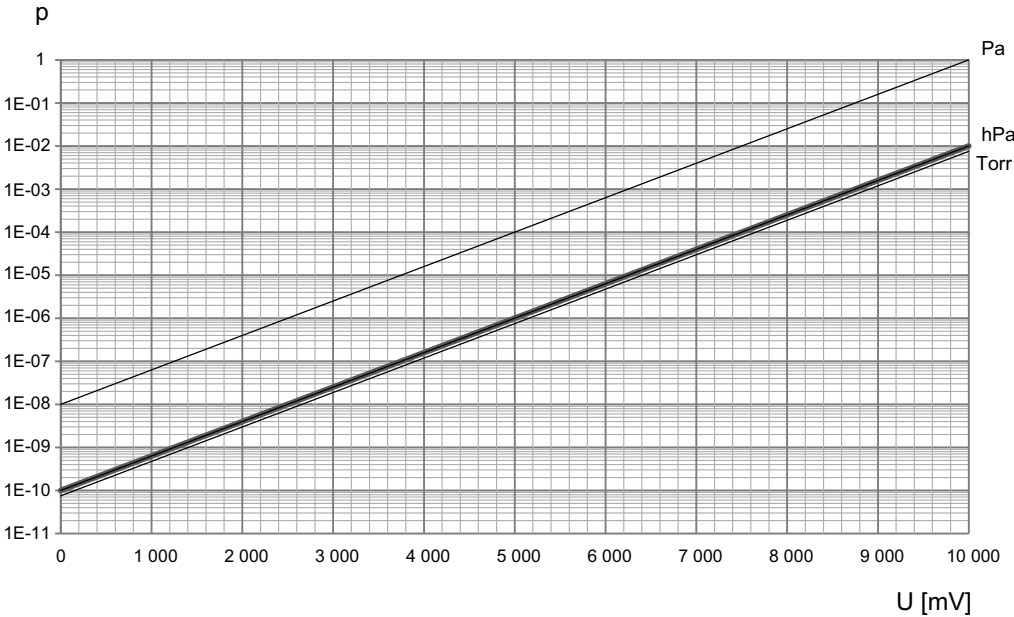
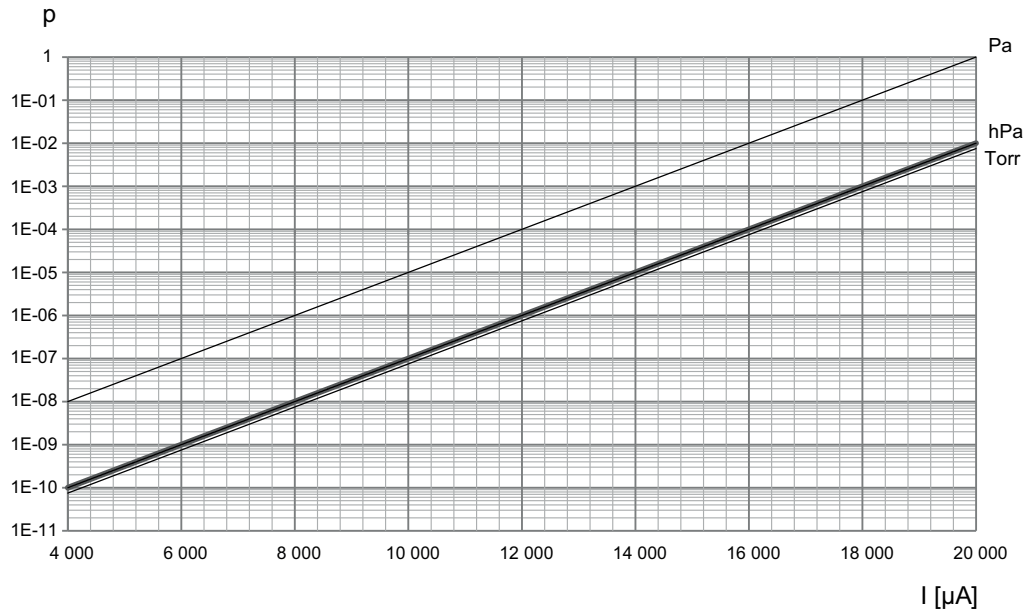

Fig. 26: Relationship between output voltage and pressure for Penning gauges on measuring board CP 300 C10

6) Dependent on unit of pressure



**Fig. 27: Relationship between output current and pressure for Penning gauges on measuring board CP 300 C10**

**Converting measuring signal and pressure**

- ▶ Convert analog output voltage into pressure:  
 $p = c \times 10^{(0.8 \times U)}$
- ▶ Convert analog output current into pressure:  
 $p = d \times 10^{(0.5 \times I)}$
- ▶ Convert pressure into analog output voltage:  
 $U = 1.25 \times (\log p - \log c)$
- ▶ Convert pressure into analog output current:  
 $I = 2 \times (\log p - \log d)$
- ▶ Observe the constants for converting measuring signal and pressure.

**Validity range**

- $1 \times 10^{-10} \text{ hPa} < p < 1 \times 10^{-2} \text{ hPa}$
- $7.5 \times 10^{-11} \text{ Torr} < p < 7.5 \times 10^{-3} \text{ Torr}$
- $1 \times 10^{-8} \text{ Pa} < p < 1 \text{ Pa}$

Measurement signal (output voltage U)	Pressure (p)	Constant (c) <sup>7)</sup>
[V]	[hPa]	$1 \times 10^{-10}$
	[mbar]	
	[Pa]	$1 \times 10^{-8}$
	[kPa]	$1 \times 10^{-11}$
	[Torr]	$7.5 \times 10^{-11}$
	mTorr	$7.5 \times 10^{-8}$

**Tbl. 12: Constant for converting output voltage and pressure for Penning gauges on measuring board CP 300 C10**

7) Dependent on unit of pressure

Measurement signal (output current I)	Pressure (p)	Constant (d) <sup>8)</sup>
[mA]	[hPa]	1.000 x 10 <sup>-12</sup>
	[mbar]	
	[Pa]	1.000 x 10 <sup>-10</sup>
	[kPa]	1.000 x 10 <sup>-13</sup>
	[Torr]	7.500 x 10 <sup>-13</sup>
	mTorr	7.500 x 10 <sup>-10</sup>

Tbl. 13: Constant for converting output current and pressure for Penning gauges on measuring board CP 300 C10

7.2.4 Conversion for Penning gauges on measuring board CP 300 T11/T11L

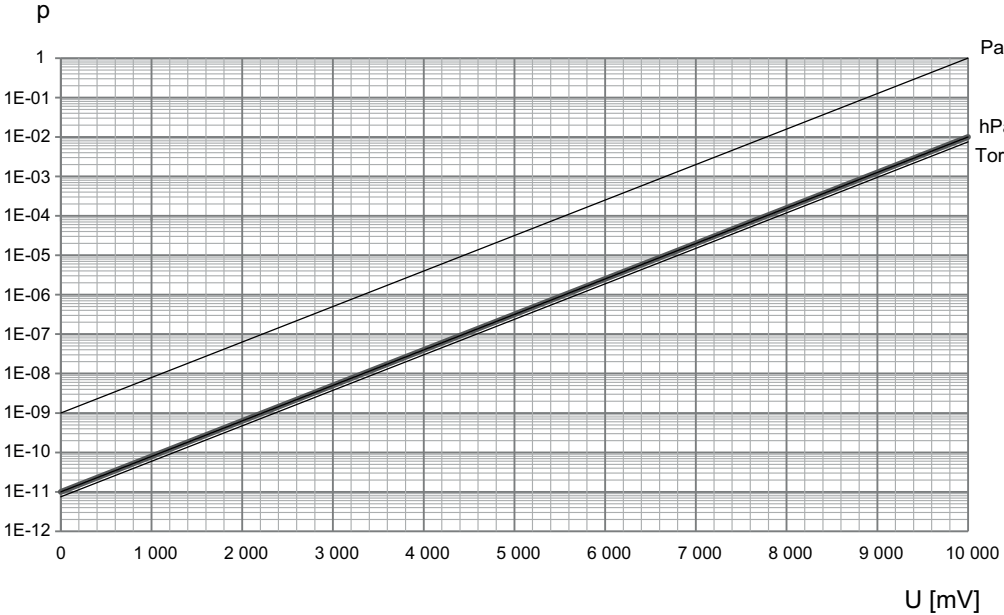
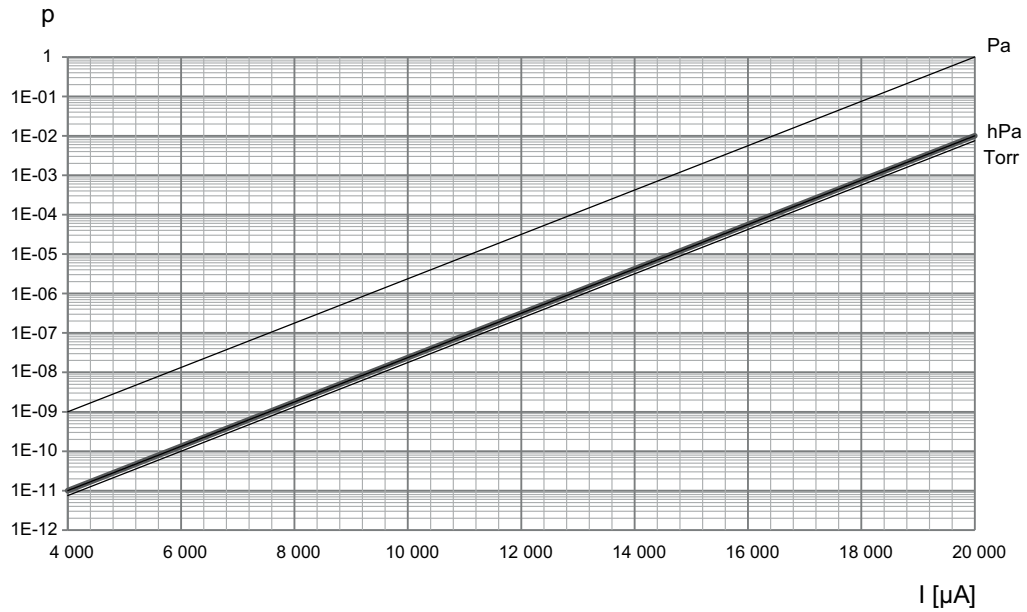

Fig. 28: Relationship between output voltage and pressure for Penning gauges on measuring board CP 300 T11/T11L

8) Dependent on unit of pressure



**Fig. 29: Relationship between output current and pressure for Penning gauges on measuring board CP 300 T11/T11L**

**Converting measuring signal and pressure**

- ▶ Convert analog output voltage into pressure:  
 $p = c \times 10^{(0.9 \times U)}$
- ▶ Convert analog output current into pressure:  
 $p = d \times 10^{(9/16 \times I)}$
- ▶ Convert pressure into analog output voltage:  
 $U = 10/9 \times (\log p - \log c)$
- ▶ Convert pressure into analog output current:  
 $I = 16/9 \times (\log p - \log d)$
- ▶ Observe the constants for converting measuring signal and pressure.

**Validity range**

- $1 \times 10^{-11} \text{ hPa} < p < 1 \times 10^{-2} \text{ hPa}$
- $7.5 \times 10^{-12} \text{ Torr} < p < 7.5 \times 10^{-3} \text{ Torr}$
- $1 \times 10^{-9} \text{ Pa} < p < 1 \text{ Pa}$

Measurement signal (output voltage U)	Pressure (p)	Constant (c) <sup>9)</sup>
[V]	[hPa]	$1 \times 10^{-11}$
	[mbar]	
	[Pa]	$1 \times 10^{-9}$
	[kPa]	$1 \times 10^{-12}$
	[Torr]	$7.5 \times 10^{-12}$
	mTorr	$7.5 \times 10^{-9}$

**Tbl. 14: Constant for converting output voltage and pressure for Penning gauges on measuring board CP 300 T11/T11L**

9) Dependent on unit of pressure



Measurement signal (output current I)	Pressure (p)	Constant (d) <sup>10)</sup>
[mA]	[hPa]	5.620 x 10 <sup>-14</sup>
	[mbar]	
	[Pa]	5.620 x 10 <sup>-12</sup>
	[kPa]	5.620 x 10 <sup>-15</sup>
	[Torr]	4.215 x 10 <sup>-14</sup>
	mTorr	4.215 x 10 <sup>-11</sup>

Tbl. 15: Constant for converting output current and pressure for Penning gauges on measuring board CP 300 T11/T11L

## 7.3 Measuring with TPG 500

### 7.3.1 Gas type dependence

Pfeiffer Vacuum has calibrated the measured value display to Nitrogen N<sub>2</sub> at the factory. The measured value display of the device depends on the gas type.



#### Characteristics for other gases

The characteristics for gases other than nitrogen can be found in the appendix of the operating instructions for the plug-in boards (N<sub>2</sub>).

### 7.3.2 Validity of the display

#### Using measuring results as regulation

- ▶ Observe the time constants of the gauges, potential ignition delays etc. when switching on the device, until the device issues usable measuring results.

### 7.3.3 Accuracy of the measured value display

A generally valid statement regarding accuracy of the measured value display cannot be made. Apart from the type of gas, the accuracy depends essentially on the current state of the sensor.

#### Determining current accuracy of the gauges

- ▶ Compare the gauges with reference gauges.
- ▶ Always use a Pfeiffer Vacuum calibration system for reliable comparison measurements, in particular for pressures of < 10<sup>-4</sup> hPa.

### 7.3.4 Calibration

Pfeiffer Vacuum has calibrated the gauge to standard values at the factory. Cold cathode measuring circuits do not require calibration.



#### Calibrating Pirani measuring circuit

You can find information on calibrating the Pirani measuring circuit in the operating instructions for the plug-in boards.

#### Calibrating Pirani measuring circuit

- ▶ Compare the Pirani measuring circuit with the 2 trim potentiometers on the measuring boards.

10) Dependent on unit of pressure

## 8 Operating modes

### 8.1 Using measuring mode

The measuring mode is the standard operating mode of the device for displaying the measured value or status.

- Displaying a measured value per measurement channel
- Displaying status messages per measurement channel
- Displaying a bar graph (where required)

#### 8.1.1 Changing measurement channel

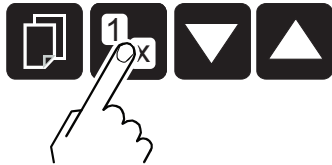

Fig. 30: Changing measurement channel

##### Procedure

- ▶ Press the "Measurement channel" button until the number (A1, A2, B1, B2) of the desired measurement channel flashes.

#### 8.1.2 Switching measuring circuit on and off

Manual switching on or off has a higher priority than automatic control.

- When manually switching on an automatically controlled measuring circuit, the measuring circuit may switch off again immediately if the switch-off condition is fulfilled.
- When manually switching off an automatically controlled measuring circuit, the measuring circuit remains switched off until you switch it back on again, or until you reset the automatic control via SENSOR CONTROL, and the switch-on condition is fulfilled.

The controller does not shut down Pirani gauges when switching off, but instead suppresses the measurement result and the error message.



Fig. 31: Switching measuring circuit on and off

##### Procedure

- ▶ Recommendation: Only switch cold cathode gauges on with pressures  $< 10^{-3}$  hPa in order to avoid excessive contamination.
- ▶ Recommendation: Where possible, switch cold cathode gauges off in order to avoid excessive contamination.
- ▶ Press the "UP" arrow key for longer than 1 second in order to switch on the gauge.
  - You may be issued a status message in place of a measured value.
- ▶ Press the "DOWN" arrow key for longer than 1 second in order to switch off the gauge.
  - You are issued the measuring point identifier in place of a measured value.

Display	Meaning
Au 9	Cold cathode measuring circuit $5 \times 10^{-9}$ hPa Controlled automatically
Au 10	Cold cathode measuring circuit $1 \times 10^{-10}$ hPa Controlled automatically

Display	Meaning
Au 11	Cold cathode measuring circuit $1 \times 10^{-11}$ hPa Controlled automatically
PE 9	Cold cathode measuring circuit $5 \times 10^{-9}$ hPa
PE 10	Cold cathode measuring circuit $1 \times 10^{-10}$ hPa
PE 11	Cold cathode measuring circuit $1 \times 10^{-11}$ hPa
PI	Pirani measuring circuit
PI n	Pirani measuring circuit for nickel filament

Tbl. 16: Displays for measuring circuits

### 8.1.3 Measured value display

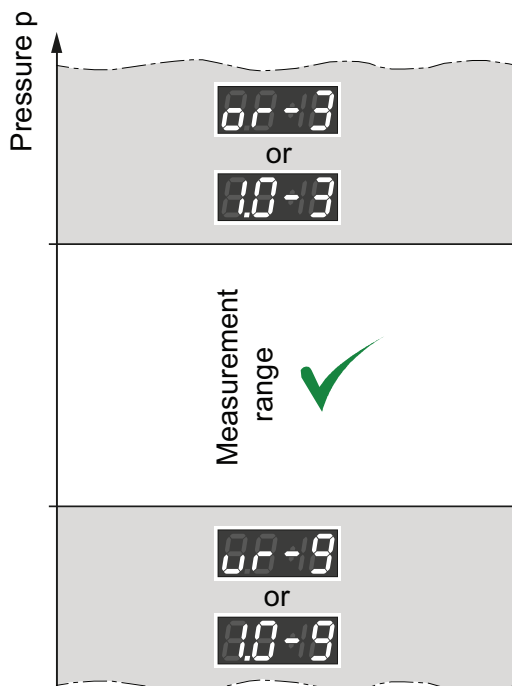

Fig. 32: Measuring range

The unit displays all 4 measuring channels simultaneously. The symbol of the active channel flashes.

- If the measured value of a measuring point is outside the measuring range, "or" or "ur" is displayed. The exponent indicates the range limit.
- Instead of "or" and "ur", the respective upper measuring range value can be displayed via the "END VALUE" parameter.
- Risks if the measuring range is exceeded: A cold cathode gauge can become contaminated if it remains switched on.

If the underrange controller is switched off, no distinction can be made in a cold cathode measuring circuit between sensor failure, cable break, and underrange. "ur" is displayed in all cases.

### 8.1.4 Identifying measuring board and gauge



Fig. 33: Identifying measuring board and gauge

**Procedure**

- ▶ Hold both arrow keys pressed for between 0.5 s and 1 s.
  - The device identifies the connected measuring board (line 1) and gauge (line 2) and displays these for 5 seconds.

**Examples for displaying connected measuring boards and gauges**

- Pirani measuring board connected (line 1): **PI300D**  
Pirani gauges connected (line 2): **TPR 010/018**
- Pirani/cold cathode measuring board connected (line 1): **CP300C9**  
Cold cathode gauge connected (line 2): **IKR 050/060**
- Plug-in board connected, but can not be identified (line 1): **noIDENT**  
Line 2 empty

### 8.1.5 Resetting unit to the factory settings

This function allows you to reset all parameters set/changed by the user to the default values (factory settings). This cannot be undone.

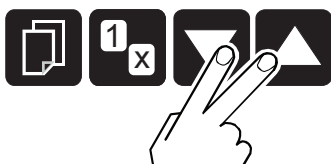

**Fig. 34: Resetting unit to the factory settings**

**Resetting unit to the factory settings**

- ▶ Keep both arrow keys pressed > 5 seconds.
  - The device loads the factory settings.
  - "DEFAULTS LOADED" appears.

## 8.2 Using parameter mode

Parameter mode is the operating mode for displaying and changing/entering parameter values, testing the device and saving measured data. All parameters are organized in parameter groups.

**Parameter groups**

- Switching function parameter (**SWITCH-POINT**)
- Gauge parameter (**SENSOR**)
- Gauge control (**SENSOR CONTROL**)
- General parameters (**GENERAL**)
- Communication parameter (**COMMUNICATION**)
- Plug-in board parameters (**PLUG-IN BOARDS**)
- Data logger mode (**DATA LOGGER**)
- Setup mode (**SETUP**)
- Test parameter (**TEST**)

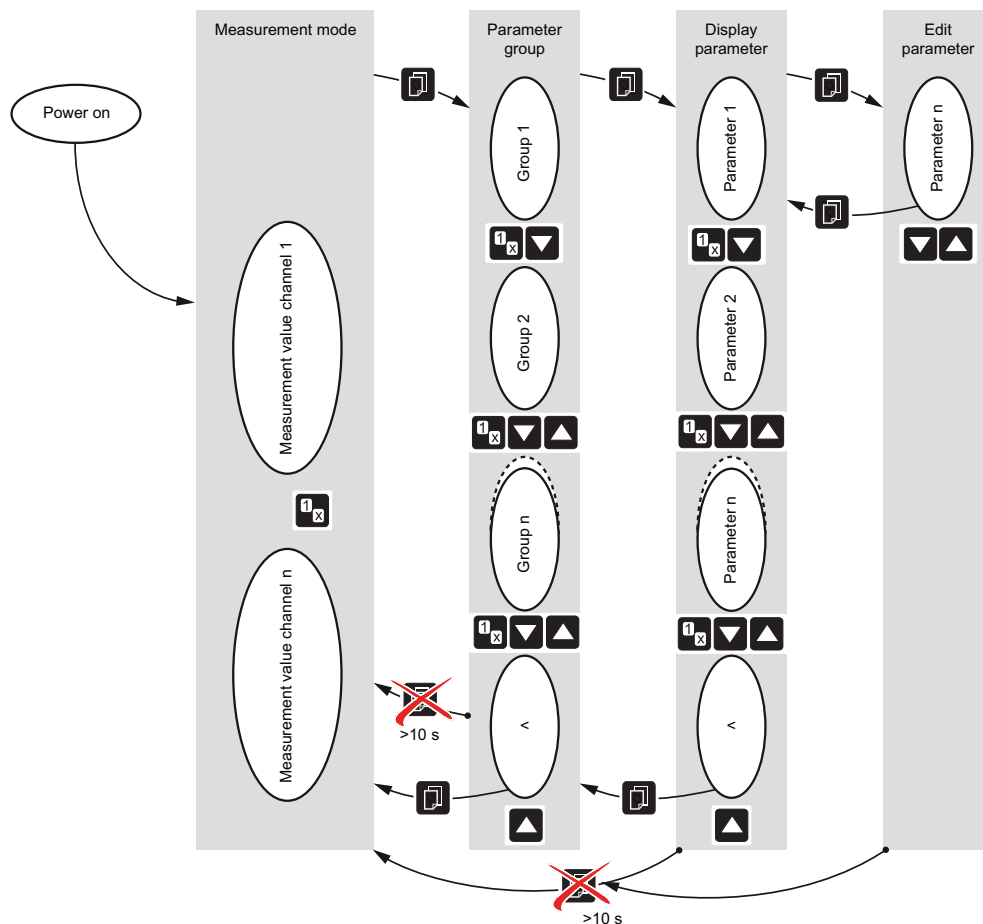

**Fig. 35: Reading/writing parameter groups and parameters**

**Change parameters**

1. Press the "Parameter" button to switch to parameter mode.
  - The display shows the respective parameter group. The symbol for Parameter mode lights up.
2. Press the "UP" and "DOWN" arrow buttons to select a parameter group.
3. Press the "Parameter" button to confirm the parameter group.
4. Read the parameters of the selected parameter group using the "UP" and "DOWN" arrow buttons.
5. Press the "Parameter" button to confirm the desired parameter.
  - The value flashes.
6. Use the "UP" and "DOWN" arrow buttons to change the value.
  - Press button < 1 s: Change value incrementally
  - Press button > 1 s: Change value continuously
7. Press the "Parameter" button to save the change.
  - You then return to read mode.

## 9 Configuring parameters

### 9.1 Switching function parameters

The switching function parameters group includes displaying and editing/entering threshold values and assigning switching functions to a measurement channel.

Parameter	Description
Setpoint n S	Assignment of Setpoint n to a measurement channel
Setpoint n L	Setpoint n: Lower threshold value (LOW)
Setpoint n H	Setpoint n: Upper threshold value (HIGH)
Setpoint n T	Delays the switching off of the relay (ON timer)

Tbl. 17: Switching function parameters

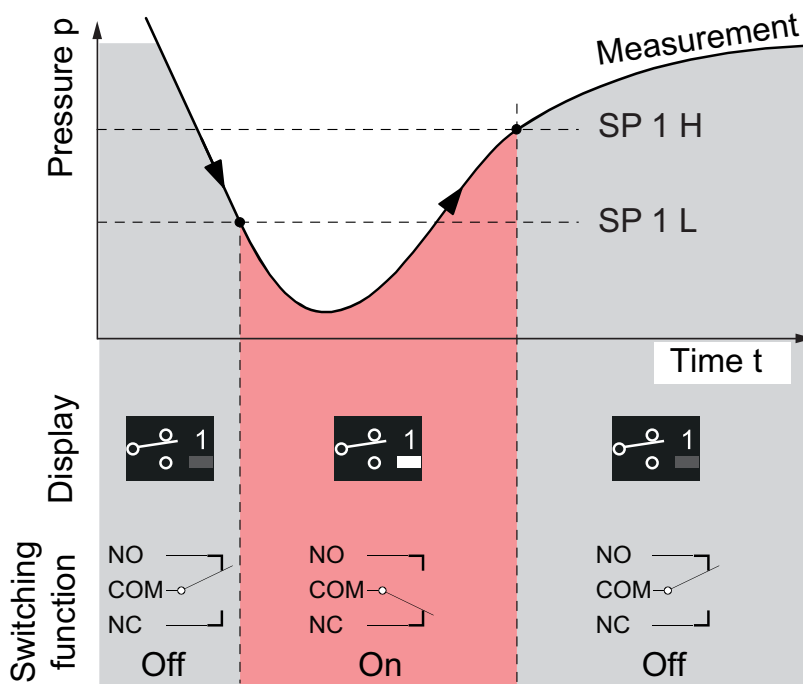

Fig. 36: Switching functions and threshold values

The lower and upper threshold value of a switching function always belong to the same channel. The last assignment to be carried out applies for both threshold values. The device has 4 switching functions in addition to the plug-in boards IF 300 x, each with two adjustable threshold values. The states of the switching functions are shown on the display and are available as zero-potential contacts at the "CONTROL" connection.

The lower threshold value (setpoint low) defines the pressure at which the switching function is switched on if the pressure drops. The upper switching function (setpoint high) defines the pressure at which the switching function is switched off if the pressure rises. The "Setpoint n L" and "Setpoint n H" parameters only appear if a sensor (SENSOR A1, SENSOR A2, SENSOR B1 or SENSOR B2) has been assigned to the setpoint.

Entering an ON timer value between 0 and 100 seconds delays the switching off of the relay. When the upper threshold value is exceeded, the relay only switches off after the set time. However, if the measured value drops below the lower threshold value within the set time, the relay remains activated and the ON timer is reset.



#### Setting the threshold values

Pfeiffer Vacuum recommends setting the upper threshold value 1/2 decade above the lower threshold value or the lower threshold value 1/2 decade below the upper threshold value.

Display	Description
SETPOINT 1 S   SENSOR A1	Switching function 1 is assigned to sensor A1.
SETPOINT 1 S   SENSOR A2	Switching function 1 is assigned to sensor A2.
SETPOINT 1 S   OFF	Switching function 1 is switched off (factory setting).
SETPOINT 1 S   ON	Switching function 1 is always switched on.
SETPOINT 1 L   1.0E-11	Limit of lower threshold value ( $1.0 \times 10^{-11}$ to $9.9 \times 10^3$ , ex factory $1.0 \times 10^{-11}$ )
SETPOINT 1 H   9.9E3	Limit of upper threshold value ( $1.0 \times 10^{-11}$ to $9.9 \times 10^3$ , ex factory $9.9 \times 10^3$ )
SETPOINT 1 T   30s	ON timer for switching function 1 set to 30 seconds (range 0 to 100 s, ex factory 0 s)

Tbl. 18: Examples of switching function displays



**Minimum hysteresis**

The hysteresis between the upper and lower threshold value is a minimum 10 % of the lower threshold value. The upper threshold value is automatically updated with minimum hysteresis if required. This prevents an unstable state.

## 9.2 Gauge parameters

The gauge parameters group includes displaying and editing/entering gauge-relevant parameters.

Parameter	Description
FILTER	Measured value filter
GAS TYPE	Correction factor for other gas types
CORRECTION FACTOR	Correction factor
NAME	Measuring point name
COMPENSATION	Stray current compensation

Tbl. 19: Gauge parameters

### 9.2.1 "FILTER" parameter

The measured value filter permits a better evaluation of measurement signals with fluctuation or interference. The measured value filter acts on the display on the device, all interface outputs (USB, etc.), the scaled analog outputs and the switching functions.

- **OFF:** The device responds as quickly as possible to fluctuations in the measured value.
- **100 Hz:** The device responds rapidly to measured value fluctuations and thus responds to measured value interference in a more sensitive manner.
- **10 Hz (ex factory):** Setting with good ratio between speed of response and sensitivity of display and switching function with respect to measured value changes.
- **1 Hz:** The device responds slowly to minor fluctuations in the measured value and is slower to respond to changes in the measured value.
- **0.1 Hz:** The device responds extremely slowly to minor fluctuations in the measured value and responds more slowly to measured value changes.

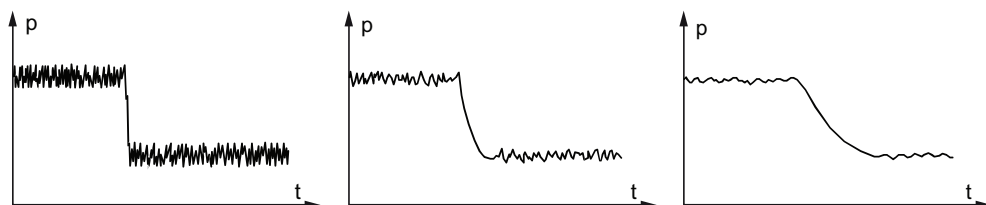

Fig. 37: Examples for measured value filters: OFF, 10 Hz and 1 Hz (from left to right)

**Setting measured value filter**

- Use the parameter to set the desired measured value filter.

### 9.2.2 "GAS TYPE" parameter

#### Setting gas type or correction factor

- ▶ Set the measuring value to the predefined gas type: nitrogen/air, neon, argon, krypton, xenon or hydrogen.
- ▶ Use the "CORRECTION FACTOR" parameter to manually enter a correction factor for other gases.

### 9.2.3 "CORRECTION FACTOR" parameter

The correction factor is effective across the entire measuring range and permits the measured value to be set to other gas types.

#### Adjusting correction factor

1. At the "GAS TYPE" parameter, set the "CORRECTION FACTOR" value.
2. Set the correction factor to a value between 0.20 and 8.00.
  - Ex factory: Correction factor 1.00 (no correction)

### 9.2.4 "NAME" parameter

#### Setting measuring point name

- ▶ Enter a measuring point name with a maximum of 8 characters, using capital letters, spaces or numbers.
  - Ex factory: Sensor A1

### 9.2.5 "COMPENSATION" parameter

The compensation value is subtracted from the measured pressure value. This enables automatic correction of pressure values that have been falsified due to stray currents resulting from long cables.

#### Setting compensation value automatically or manually

- ▶ Keep the "UP" arrow key pressed for approx. 1 second to automatically measure the compensation value.
  - The "MEASUREMENT..." text appears.
- ▶ For each measurement channel with cold cathode, set a desired compensation value manually via interface command.
  - Ex factory: OFF (compensation deactivated)

## 9.3 Gauge control

The gauge control group comprises the display and editing/input of parameters used to define how gauges are switched on and/or off.

Parameter	Description
SENSOR ON	Gauge switch-on type
SENSOR OFF	Gauge switch-off type
THRESHOLD VALUE ON	Switch-on threshold value
THRESHOLD VALUE OFF	Switch-off threshold value

Tbl. 20: Gauge control

#### Basic principles of the gauge control

- Various controlling sources can be used to switch a gauge on and off.
- A gauge cannot switch itself on.
- Pirani gauges remain active after being switched off.
  - "PI" appears on the display in place of the measured value.

### 9.3.1 "SENSOR ON" parameter

The "SENSOR A1", "SENSOR A2", "SENSOR B1" and "SENSOR B2" parameter values are only displayed for the available channels in each case.



**Switching on the gauge**

- ▶ Select "HAND" (set ex factory) and switch on the gauge manually with the "UP" arrow key.
- ▶ Choose "HOTSTART".
  - The gauge switches on automatically when the device is switched on. This allows measuring to continue following a power failure.
- ▶ Choose "SENSOR n".
  - The gauge on measurement channel n automatically switches the gauge on when the switch-on condition is fulfilled, or when the THRESHOLD VALUE ON is not reached.
- ▶ Select "HOTSTART + n".
  - The gauge switches on automatically when the device is switched on. Then, the switch-on behavior is controlled by measurement channel n.
- ▶ Select "PREVIOUS".
  - The gauge is operated in the same state as prior to the last power cycle.
- ▶ Select "PREVIOUS + n".
  - The gauge is operated in the same state as prior to the last power cycle. Then, the switch-on behavior is controlled by measurement channel n.

**9.3.2 "SENSOR OFF" parameter**

The "SENSOR A1", "SENSOR A2", "SENSOR B1" and "SENSOR B2" parameter values are only displayed for the available channels in each case.

**Switching off the gauge**

- ▶ Select "HAND" (set ex factory) and switch off the gauge manually with the "DOWN" arrow key.
- ▶ Choose "SELF".
  - Self-monitoring: The gauge switches off automatically in case of a pressure rise.
- ▶ Choose "SENSOR n".
  - The gauge on measurement channel n automatically switches the gauges off.

**9.3.3 "THRESHOLD ON" parameter**

The "THRESHOLD ON" parameter defines the activation threshold value when using the gauge on the other channel to switch on.

This parameter is only displayed if the switch-on type is set to SENSOR n, HOTSTART + n, PREVIOUS + n.

**Prerequisite**

- "THRESHOLD OFF"  $\geq$  "THRESHOLD ON"

**Defining the activation threshold value**

- ▶ Define an activation threshold value with the parameter "THRESHOLD ON".
  - If the pressure on the measuring channel in question falls below the activation value, the device switches on the gauges.

**9.3.4 "THRESHOLD OFF" parameter**

The "THRESHOLD OFF" parameter defines the deactivation threshold value when using the gauge on another channel to switch off, or in case of self-monitoring. This parameter is only displayed if the deactivation type is set to "SELF", "SENSOR A1", "SENSOR A2", "SENSOR B1" or "SENSOR B2".

**Prerequisite**

- "THRESHOLD OFF"  $\geq$  "THRESHOLD ON"

**Defining deactivation threshold value**

- ▶ Define a deactivation threshold value with the parameter "THRESHOLD OFF".
  - If the pressure on the measuring channel in question exceeds the deactivation value, the device switches off the gauge.

## 9.4 General parameters

### NOTICE

#### Material damage to property as a result of terminating the current connection

Resetting the parameters to the factory settings also resets the switching functions and communication parameters (e.g. Baud rate, Ethernet settings). Resetting terminates the current connection and could lead to malfunctions or possible damage to plants in which the device is integrated.

- ▶ Ensure that termination of the current connection and resetting the switching functions will not lead to malfunctions before you reset the parameters to the factory settings.

The general parameters group includes displaying and editing/entering generally valid parameters (system parameters).

Parameter	Description
UNIT	Unit of measurement
ANALOG OUTPUT	Analog output
ERROR RELAY	Error relay
PENNING-UR	Penning underrange
BARGRAPH / GRAPH	Display in bargraph or pressure curve over time
CONTRAST LCD	Contrast setting
BACKLIGHT	Background lighting
SCREENSAVER	Screensaver
SET DEFAULTS	Factory settings
LANGUAGE	Language
END VALUE	Representation of the upper range value

Tbl. 21: General parameters

### 9.4.1 "UNIT" parameter

The "UNIT" parameter defines the unit of measurement for the measured values, threshold values etc. The torr and micron units are only available if the torr lock is not active.

#### Setting unit

- ▶ Set the unit to hPa (ex factory), mbar, torr, pascal, micron, volt or ampere.

### 9.4.2 "ANALOG OUTPUT" parameter

The "ANALOG OUTPUT" parameter defines the output characteristic of the 4 analog outputs.

- **OFF**: switched off (ex factory)
- **0 – 5 V**: Fastest possible direct output of measurement signals
- **0 – 10 V**: Output of measurement signals scaled and filtered to 0 bis 10 V
- **4 – 20 mA**: Output of measurement signals scaled and filtered to 4 – 20 mA

#### Setting output characteristics

- ▶ Use the parameter to set the desired output characteristics for the analog outputs.

### 9.4.3 "ERROR RELAY" parameter

The "ERROR RELAY" parameter defines the switching behavior of the error relay.

- **ALL ERRORS**: Relay switches for all errors (ex factory)
- **DEVICE ERROR**: Relay only switches for device errors
- **SENSOR n ERROR**: Relay switches for sensor n errors and device errors

#### Setting switching behavior of error relay

- ▶ Use the parameter to set the desired switching behavior of the error relay.

#### 9.4.4 "PENNING-UR" parameter

##### NOTICE

###### Unintentional results with controller connected

Switch relay not dependent on pressure. Starting the test program can lead to unintentional results on the connected control.

- ▶ Unplug the connected measuring and control cable.
- ▶ Prevent triggering of incorrect control commands or messages.

The "PENNING-UR" parameter defines the behavior in the event of falling short of the measuring range for cold cathode gauges (Penning underrange control).

Various causes can lead to underrange values:

- The pressure in the vacuum system is below the measuring range.
- The measuring element has (not) yet ignited.
- Discharge has stopped.
- A defect has occurred.

Switching off the function is advantageous when it is possible that the pressure in the vacuum system drops below the measuring range of the gauge.

When the function is on, the device suppresses evaluation of the switching function for 10 seconds following activation of the gauge and after returning from falling short of the measuring range. The switching function remains OFF for this time.

Cold cathode measuring points for  $10^{-11}$  hPa may require more than 10 seconds for the transition from OR to UR and thus lead to a brief ON state of the switching function.

- **OFF** (ex factory): Falling short of the measuring range is interpreted as permitted measured value, UR appears, and the switching function remains ON.
- **ON**: Falling short of the measuring range is interpreted as invalid measured value, UR appears, and the switching function switches to OFF.

###### Setting behavior for when a measuring range is fallen short of

- ▶ Switch the function on or off.

#### 9.4.5 "BARGRAPH / GRAPH" parameter

The display can show a bargraph or the measured pressure as a function of time ( $p = f(t)$ ). During parameter setting, the parameter and the parameter value are displayed here.

- **OFF**: switched off (ex factory)
- **FULLSCALE**: Bar graph over entire measuring range of the gauge
- **FULLSCALE+SP**: Bar graph over entire measuring range of the gauge and switch-point threshold value
- **DECADE**: Bar graph over one decade in accordance with current measured value
- **DECADE+SP**: Bar graph over one decade in accordance with current measured value and switch-point threshold value
- **f(0.2s)**:  $p = f(t)$ , auto-scaled, 0.2 seconds / pixel

The device stores a measured value in tabular form every 200 ms for each measurement channel, and shows the last 100 measured values (= 100 pixels) auto-scaled. The illustrated data series corresponds with a recording duration of 20 seconds.

- **f(1s)**:  $p = f(t)$ , auto-scaled, 1 second / pixel

The device stores a measured value in tabular form every second for each measurement channel, and shows the last 100 measured values (= 100 pixels) auto-scaled. The illustrated data series corresponds with a recording duration of 100 seconds.

- **f(6s)**:  $p = f(t)$ , auto-scaled, 6 seconds / pixel

The device stores a measured value in tabular form every 6 seconds for each measurement channel, and shows the last 100 measured values (= 100 pixels) auto-scaled. The illustrated data series is equivalent to a recording duration of 10 minutes.

- **f(1min):**  $p = f_{(t)}$ , auto-scaled, 1 minute / pixel  
The device stores a measured value in tabular form every 60 seconds for each measurement channel, and shows the last 100 measured values (= 100 pixels) auto-scaled. The illustrated data series is equivalent to a recording duration of 100 minutes.
- **f(0.5h):**  $p = f_{(t)}$ , auto-scaled, 30 minutes / pixel  
The device stores a measured value in tabular form every 30 minutes for each measurement channel, and shows the last 100 measured values (= 100 pixels) auto-scaled. The illustrated data series is equivalent to a recording duration of 50 hours.
- **IDENTIFICATION:** The plug-in board identifier (line 1) and the measuring point name (line 2) are displayed for the selected measuring circuit.
- **SWITCH-POINTS:** The name of the measuring point (line 1) and the assigned switch-points (line 2) are displayed for the selected measuring circuit.

### Setting display

- ▶ Use the parameter to set the desired measured value display.

## 9.4.6 "CONTRAST LCD" parameter

The "CONTRAST LCD" parameter defines the value for the contrast of the LCD display.

### Setting contrast

- ▶ With the parameter, set the contrast to a value between 0 and 100 % (full contrast).
  - Ex factory = 40 %

## 9.4.7 "BACKLIGHT" parameter

The "BACKLIGHT" parameter defines the value for the background lighting of the LCD display.

### Setting background lighting

- ▶ With the parameter, set the background lighting to a value between 0 and 100 %.
  - Ex factory = 40 %

## 9.4.8 "SCREESAVER" parameter

The "SCREESAVER" parameter is used to set the screensaver to different times. The "DARKROOM" setting will switch off the background lighting completely after 1 minute.

### Setting screensaver

- ▶ Use the parameter to set the screensaver to the desired time:
  - Off (ex factory), 10 minutes, 30 minutes, 1 hour, 2 hours, 8 hours, Darkroom

### Reactivating the background light

- ▶ Press any key to disable the screensaver.

## 9.4.9 "SET DEFAULTS" parameter

The "SET DEFAULTS" parameter allows you to reset all parameters set/changed by the user to the default values (factory settings). This cannot be undone.

### Resetting unit to the factory settings

- ▶ Keep both arrow keys pressed > 5 seconds.
  - The device loads the factory settings.
  - "DEFAULTS LOADED" appears.

## 9.4.10 "LANGUAGE" parameter

The "LANGUAGE" parameter defines the language for the display.

### Setting language

- ▶ Use the parameter to set the desired language:
  - English (ex factory), German, French

## 9.4.11 "END VALUE" parameter

The "END VALUE" parameter defines the display in the event of the measuring range being fallen short of or exceeded.

- **UR/OR:** UR or OR is displayed (ex factory)
- **VALUE:** The respective measuring range end value is displayed.

#### Setting display

- ▶ Use the parameter to set the desired display.

## 9.5 Communication parameters

The communication parameters group comprises the display and editing/input of communication parameters.

Parameter	Description
BAUD RATE USB	Baud rate of the USB interface
BAUD RATE IFxxx	Baud rate of the IF 300 x plug-in board
BAUD RATE RS485	Baud rate of the RS485 interface
RS485 ADDRESS	RS-485 device address
PROTOCOL	Serial interface protocol
DHCP (ETH)	Dynamic Host Configuration Protocol (Ethernet)
IP (ETH)	IP Address (Ethernet)
SUBNET (ETH)	Subnet mask (Ethernet)
GATEWAY (ETH)	Gateway address (Ethernet)

Tbl. 22: Communication parameters

### 9.5.1 "BAUD RATE USB" parameter

The "BAUD RATE USB" parameter defines the transfer rate of the USB interface.

#### Setting transfer rate for USB interface

- ▶ Use the parameter to set the transfer rate to 9600 baud, 19200 baud, 38400 baud, 57600 baud or 115200 baud.
  - Ex factory = 9600 baud

### 9.5.2 "BAUD RATE IFxxx" parameter

The "BAUD RATE IFxxx" parameter defines the transfer rate of the IF 300 x plug-in boards. If an IF 500 PN Profinet board is plugged in, the parameter does not appear.

#### Setting transfer rate for IF 300 x plug-in boards

- ▶ Use the parameter to set the transfer rate to 1200 baud, 2400 baud, 4800 baud, 9600 baud or 19200 baud.
  - Ex factory = 9600 baud
- ▶ Set the transfer rate of the IF 300 P Profibus interface board to **19200 baud**.

### 9.5.3 "BAUD RATE RS485" parameter

The "BAUD RATE RS485" parameter defines the transfer rate of the RS-485 interface.

#### Setting transfer rate for RS-485 interface

- ▶ Use the parameter to set the transfer rate to 9600 baud, 19200 baud, 38400 baud, 57600 baud or 115200 baud.
  - Ex factory = 9600 baud

### 9.5.4 "RS485 ADDRESS" parameter

The "RS485 ADDRESS" parameter defines the RS-485 device address.

#### Setting RS-485 device address

- ▶ Use the parameter to set the address of the RS-485 device to the desired value between 1 and 24.
  - Ex factory = 1

### 9.5.5 "PROTOCOL" parameter

The "PROTOCOL" parameter defines the protocol of the serial interface (RS-485, USB-B, Ethernet).

- **AUTOMATIC:** Automatic detection (ex factory)
- **PFEIFFER VACUUM:** Pfeiffer Vacuum protocol
- **MNEMONIC 3 CHAR:** Mnemonics protocol

**Setting protocol of serial interface**

- ▶ Use the parameter to set the protocol of the serial interface.

### 9.5.6 "DHCP (ETH)" parameter

The "DHCP (ETH)" parameter defines the Dynamic Host Configuration Protocol. The DHCP enables automatic allocation of the network configuration (IP address, subnet mask, gateway) to clients by the server. If you switch the function on, the IP address, subnet mask and gateway are automatically set, but cannot be changed.

**Setting Dynamic Host Configuration Protocol**

- ▶ With the parameter, switch the Dynamic Host Configuration Protocol on or off.
  - Ex factory = function switched off (manual setting of network configuration)

### 9.5.7 "IP (ETH)" parameter

The "IP (ETH)" parameter defines the IP address of the device.

**Prerequisite**

- DHCP switched off

**Setting IP address of device**

- ▶ Use the parameter to set the IP address of the device.

### 9.5.8 "SUBNET (ETH)" parameter

The "SUBNET (ETH)" parameter defines the subnet mask of the device.

**Prerequisite**

- DHCP switched off

**Setting subnet mask of device**

- ▶ Use the parameter to set the subnet mask of the device.

### 9.5.9 "GATEWAY (ETH)" parameter

The "GATEWAY (ETH)" parameter defines the gateway address of the device.

**Prerequisite**

- DHCP switched off

**Setting gateway address of device**

- ▶ Use the parameter to set the gateway address of the device.

## 9.6 Plug-in board parameters

The plug-in board parameters group displays plug-in board parameters.

Parameter	Description
IDENTIFICATION	Identification of the plug-in board
HARDWARE VERSION	Hardware version of the plug-in board
SOFTWARE VERSION	Software version of the plug-in board
SOFTWARE UPDATE	Software update of the plug-in board

**Tbl. 23: Plug-in board parameters**

The hardware and software versions as well as the software update can only be displayed for IF 500 PN plug-in boards.

Display	Description
IDENTIFICATION   IF500PN	Identification of the plug-in board
HARDWARE VERSION   V010100	The hardware version is displayed
HARDWARE VERSION   -	The hardware version is not displayed
SOFTWARE VERSION   V010100	The software version is displayed
SOFTWARE VERSION   -	The software version is not displayed
SOFTWARE UPDATE   V+/Λ2s	Software update of the latest generation of plug-in boards via USB stick

**Tbl. 24: Examples of displays for plug-in board parameters**

#### Updating software of IF 500 PN plug-in board

1. Insert the USB stick with the new software version for the plug-in board.
2. Press both arrow keys simultaneously.
  - The software is updated. "RUNNING" and "DONE" are displayed.

## 9.7 Data logger mode

The data logger group encompasses parameters for recording measured data to a USB storage medium (USB interface type A) and for deleting recorded measured data from a USB storage medium.

#### Prerequisite

- A USB storage medium (≤ 32 GB) in the FAT file system (FAT32) is plugged in



#### USB storage media

The device does not recognize all USB storage media automatically, for instance if they do not comply with the USB standard. Try using a different storage medium first before contacting your nearest Pfeiffer Vacuum Service Center.

Parameter	Description
MODE	Manual recording/start automatically
DATE	Current date
TIME	Current time
INTERVAL	Recording interval
DEC-SEPARATOR	Decimal separator
FILE NAME	File name
START/STOP	Start/stop recording
CLEAR	Deletion of files with recorded measured data

**Tbl. 25: Parameters in data logger mode**

### 9.7.1 "MODE" parameter

The "MODE" parameter defines the start of data recording.

#### Automatically starting measured data recording

1. Set the "MODE" parameter to automatic.
2. Insert a storage medium in the USB interface type A.
  - The device recognizes the storage medium and starts the recording.
3. Disconnect the storage medium for the device in order to stop the recording.
4. Alternatively: Press "▼ TO STOP" to stop the recording.

#### **Manually starting or stopping measured data recording**

- ▶ Press the "UP" button to begin the recording.
  - Recording is in progress, the display switches to "▼ TO STOP" and the "Parameter mode" symbol starts flashing.
- ▶ Press the "DOWN" button to stop recording.
  - Recording stops, the display switches to "▲ TO START" and the "Parameter mode" symbol starts flashing.
- ▶ Press the "Parameter" button to exit write mode.
  - The device then returns automatically to measuring mode after approx. 10 seconds.

### **9.7.2 "DATE" parameter**

The "DATE" parameter defines the current date.

#### **Setting date**

- ▶ Use the parameter to set the date to the YYYY-MM-DD format.

### **9.7.3 "TIME" parameter**

The "TIME" parameter defines the current time.

#### **Setting current time**

- ▶ Use the parameter to set the current time in hh:mm [24 h] format.

### **9.7.4 "INTERVAL" parameter**

The "INTERVAL" parameter defines the interval of the measured data recording.

#### **Setting interval for measured data recording**

- ▶ Use the parameter to set the interval for recording measured data to 1 s, 10 s, 30 s, 1 min, 1 % DEVIATION for measured value changes  $\geq 1\%$  or 5 % DEVIATION for measured value changes  $\geq 5\%$ .

### **9.7.5 "DEC-SEPARATOR" parameter**

The "DEC-SEPARATOR" parameter defines the decimal separator for the measured values during measured data recording. The decimal separator is important for further processing with a spreadsheet program.

#### **Setting decimal separator**

- ▶ Use the parameter to set the decimal separator to a point or a comma.

### **9.7.6 "FILE NAME" parameter**

The "FILE NAME" parameter defines the name of the measured data file.

#### **Defining the name of the measured data file**

1. Define the name of the measured data file with a max. 8 characters.
  - The file extension is CSV.
2. If the name has fewer than 8 characters, complete the name with blank spaces.

After entering the 8th character, the display stops flashing. The device stores the name and returns once again to read mode.

### **9.7.7 "START / STOP" parameter**

The "START/STOP" function starts or stops measured data recording. The symbol for parameter mode flashes during measured data recording.



**Manually starting or stopping measured data recording**

- ▶ Press the "UP" button to begin the recording.
  - Recording is in progress, the display switches to "▼ TO STOP" and the "Parameter mode" symbol starts flashing.
- ▶ Press the "DOWN" button to stop recording.
  - Recording stops, the display switches to "▲ TO START" and the "Parameter mode" symbol starts flashing.
- ▶ Press the "Parameter" button to exit write mode.
  - The device then returns automatically to measuring mode after approx. 10 seconds.

**9.7.8 "CLEAR" parameter**

The "CLEAR" function deletes all measured data files (with CSV file extension) from the USB storage medium, except SETUP\*\*\*.csv.

**Deleting measured data files**

- ▶ Press both arrow keys simultaneously.
  - RUNNING and DONE are displayed.

**9.8 Setup mode**

The Setup Mode group encompasses functions for saving, loading and deleting parameters from or to a USB storage medium, as well as for formatting a USB storage medium.

**Prerequisite**

- A USB storage medium (≤ 32 GB) in the FAT file system (FAT32) is plugged in

Parameter	Description
SAVE TO	Save all parameters
RESTORE FROM	Write all parameters to the device
FORMAT	Format the USB storage medium (FAT32)
CLEAR	Delete files with stored parameters

**Tbl. 26: Parameters in setup mode**

Display	Description
<b>RUNNING</b>	The device is saving or loading the CSV file. Formatting in progress. The device is deleting the files.
<b>DONE</b>	Saving or loading is complete. The formatting process is complete. Deleting of the files is complete.
<b>ERROR</b>	An error has occurred.

**Tbl. 27: Examples for displays in setup mode**

**9.8.1 "SAVE TO" parameter**

The "SAVE TO" function saves all parameters of the device to a USB storage medium (file: SETUPxx.CSV).

**Selecting a file name**

- ▶ Select a file name between SETUP01 and SETUP99.

**9.8.2 "RESTORE FROM" parameter**

The "RESTORE FROM" function loads all parameters from a USB storage medium on to the device.

**Selecting a file name**

- ▶ Select a file name between SETUP01 and SETUP99.

### 9.8.3 "FORMAT" parameter

The "FORMAT" function formats a USB storage medium.

#### Formatting the USB storage medium

- ▶ Press both arrow keys simultaneously.

### 9.8.4 "CLEAR" parameter

The "CLEAR" function deletes all parameter files (with CSV file extension) from a USB storage medium.

#### Deleting parameter files from a USB storage medium

- ▶ Press both arrow keys simultaneously.

## 9.9 Test parameters

The test parameters group includes displaying the firmware version, editing and input of special parameter values, and the test programs.

Parameter	Description
SOFTWARE VERSION	Firmware version (program version) <sup>11)</sup>
HARDWARE VERSION	Hardware version <sup>12)</sup>
MAC ADDRESS	MAC address of the device, without separator characters, for example: 00-A0-41-0A-00-08 appears as 00A0410A0008.
RUNHOURS	Operating hours of the device
WATCHDOG	Watchdog error behavior
TORR-LOCK	The torr lock suppresses the torr and micron units of measurement as a parameter value when settings are entered. This function is disabled in the factory setting.
KEY-LOCK	The key lock prevents unintentional entries in parameter mode and thus any malfunctions. This function is disabled in the factory setting.
FLASH TEST	FLASH test (program memory)
EEPROM TEST	EEPROM test (parameter memory)
DISPLAY TEST	Display test
RELAY TEST	Relay test
RECALIBRATION	Recalibration

**Tbl. 28: Test parameters**

#### Calling the test parameter group

- ▶ Press the "Parameter" button when switching on the device.
- or
- ▶ Hold the "Parameter" button pressed for 5 seconds when " < " is displayed.

### 9.9.1 "WATCHDOG" parameter

The "WATCHDOG" function defines the behavior of system monitoring (Watchdog Control) in the event of an error.

- **AUTO** (ex factory)  
The system acknowledges a Watchdog malfunction message automatically after 2 hours.
- **OFF**  
The user must acknowledge a malfunction message.

#### Setting watchdog

- ▶ Set the function to Auto or OFF using the parameter.

11) This information is useful if you need to contact Pfeiffer Vacuum.

12) This information is useful if you need to contact Pfeiffer Vacuum.

### 9.9.2 "FLASH TEST" parameter

The "FLASH TEST" function tests the program memory of the device.

#### Testing the program memory

1. Press both arrow keys simultaneously.
2. Contact [Pfeiffer Vacuum Service](#) if the error persists when the test is repeated.

#### Displays during the test

- **RUNNING**: The test is running (very short).
- **OK**: The test is complete and the device has not determined any errors.
- **ERROR**: The test is complete and the device has determined errors.

### 9.9.3 "EEPROM TEST" parameter

The "EEPROM TEST" function tests the parameter memory of the device.

#### Testing parameter memory

1. Press both arrow keys simultaneously.
2. Contact [Pfeiffer Vacuum Service](#) if the error persists when the test is repeated.

#### Displays during the test

- **RUNNING**: The test is running.
- **OK**: The test is complete and the device has not determined any errors.
- **ERROR**: The test is complete and the device has determined errors.

### 9.9.4 "DISPLAY TEST" parameter

The "DISPLAY TEST" function tests the display elements of the device.

#### Testing the display

1. Press both arrow keys simultaneously.
  - When the test is initiated, all display elements light up simultaneously for 10 seconds.
2. Contact [Pfeiffer Vacuum Service](#) in the event of any errors.

### 9.9.5 "RELAY TEST" parameter

#### NOTICE

##### Unintentional results with controller connected

Switch relay not dependent on pressure. Starting the test program can lead to unintentional results on the connected control.

- ▶ Unplug the connected measuring and control cable.
- ▶ Prevent triggering of incorrect control commands or messages.

The "RELAY TEST" function tests the relays in the device and their switching functions.

#### Instrument required

- Ohmmeter

#### Testing relays

1. Press both arrow keys simultaneously.
  - The relays switch on and off cyclically.
  - The display visually indicates the switching operations.
  - The switching operations also emit a clearly audible sound.
2. Ensure correct switching functions of the contacts at the "CONTROL" connection using an ohmmeter.
3. Contact [Pfeiffer Vacuum Service](#) in the event of any errors.

#### Displays during the test

- **OFF**: All relays are switched off.
- **REL n ON**: Relay n is switched on.
- **REL n OFF**: Relay n is switched off.

### 9.9.6 "RECALIBRATION" parameter

The "RECALIBRATION" function shows the data of the next recalibration. After the set date is reached, "RECALIBRATION REQUIRED!" is displayed.

#### Setting date of next recalibration

- ▶ Use the parameter to set the date of the next recalibration as desired.

## 10 Decommissioning

### Switching off unit

1. Switch off the unit at the mains switch.
2. **In the case of rack installation or switchboard installation:** Switch off the unit centrally using the switched mains distributor.
3. Wait at least 10 seconds before switching it back on again, so that the device can reinitialize.

# 11 Maintenance



## Maintenance in the Pfeiffer Vacuum Service Center

Pfeiffer Vacuum offers a complete maintenance service for all products.

Pfeiffer Vacuum recommends: Contact your Pfeiffer Vacuum Service Center to arrange the maintenance of defective products and components.



## Cleaning in the Pfeiffer Vacuum Service Center

Pfeiffer Vacuum recommends: Contact your nearest Pfeiffer Vacuum Service Center to arrange the cleaning of heavily-soiled products and components.



## Warranty claim

Opening the device during the warranty period or damaging/removing the warranty seal will void the warranty.

Contact the Pfeiffer Vacuum Service Center in the event of process-related shorter maintenance intervals.

## 11.1 Cleaning the device

### **⚠ DANGER**

#### Electric shock due to moisture entering the unit

Water that has entered the unit will result in personal injury through electric shocks.

- ▶ Only operate the unit in a dry environment.
- ▶ Operate the unit away from fluids and sources of moisture.
- ▶ Do not switch on the unit if fluid has entered it. Instead contact Pfeiffer Vacuum Service.
- ▶ Always disconnect the power supply before cleaning the unit.

### **⚠ WARNING**

#### Health hazards due to cleaning agent

The cleaning agent being used causes health hazards which could include, for example, poisoning, allergies, skin irritations, chemical burns or damage to the airways.

- ▶ When handling cleaning agents, observe the applicable regulations.
- ▶ Adhere to safety measures regarding handling and disposal of cleaning agents.
- ▶ Be aware of potential reactions with product materials.

### **NOTICE**

#### Damage caused by penetrating moisture

Penetrating moisture, e.g. through condensation or dripping water, damages the device.

- ▶ Protect the device against moisture penetrating.
- ▶ Only operate the device in a clean and dry environment.
- ▶ Operate the device away from fluids and humidity sources.
- ▶ Take special precautions if there is a risk of dripping water.
- ▶ Do not switch on the device if fluid has penetrated into it, instead contact the Pfeiffer Vacuum Service Center.

### **NOTICE**

#### Damage caused by unsuitable cleaning agents

Unsuitable cleaning agents damage the product.

- ▶ Do not use solvents as they attack the surface.
- ▶ Do not use any aggressive or abrasive cleaning agents.

**Prerequisites**

- Device is switched off
- Mains plug is removed

**Required consumable material**

- Common cleaning agent (e.g. mild household detergent).
- Clean, soft cloth

**External cleaning of the device**

1. Use a soft, damp cloth to clean the surfaces.
2. Allow the surfaces to dry thoroughly after cleaning.

## 11.2 Replacing the battery

The product contains a battery (type CR2032, service life > 10 years), in order to maintain the data integrity of the real-time clock. A battery replacement is necessary if the real-time clock repeatedly displays an incorrect date.

**Procedure**

- ▶ Contact your nearest [Pfeiffer Vacuum Service Center](#).

## 11.3 Updating firmware

**USB storage media**

The device does not recognize all USB storage media automatically, for instance if they do not comply with the USB standard. Try using a different storage medium first before contacting your nearest Pfeiffer Vacuum Service Center.

The settings you changed in parameter mode are usually also available after performing a firmware update. However, we recommend that you store the parameters in setup mode before performing an update.

**Prerequisites for the USB update tool**

- Microsoft Windows XP, 7, 8 or 10 operating system
- No USB storage medium connected to the front side of the device

**Updating firmware**

- ▶ Contact your nearest [Pfeiffer Vacuum Service Center](#) if your device requires a more recent firmware version, in order to support new gauges for example.
- ▶ Update the firmware of your device using a USB storage medium (USB type A on the front side of the device).
- ▶ Alternatively: Update the firmware of your device using the USB Update Tool via the USB type B connection on the rear side of the device.

**Updating the firmware with a USB storage medium (USB type A)**

1. Open the Pfeiffer Vacuum [Download Center](#) in the browser.
2. Enter the name of your device as the keyword.
3. Select "Software".
  - The display lists the available documents and software.
4. Download the ZIP file in the desired language.
  - The ZIP file contains the files with file extension ".S19" and ".CNF".
5. Unzip both files.
6. Save both files on the USB storage medium.
7. Turn off the device.
8. Plug the USB storage medium into the device.
9. Turn on the device.
  - The update takes place automatically.
10. Remove the USB storage medium from the device.
  - The device automatically restarts.
11. If required, write the customer-specific settings that were stored before the update back to the device.

Updating via a USB storage media is an automatic process with the following steps. The following appears on the display:

1. **BOOTING:** very briefly
2. **BOOTLOADER V1.x:** very briefly
3. **ERASING FW...:** Old firmware is deleted from the device.
4. **UPDATING FW...:** New firmware is written to the device.
5. **UPDATE COMPLETE:** Update is done.

### Updating firmware with the USB Update Tool (USB type B)

1. Open the Pfeiffer Vacuum [Download Center](#) in the browser.
2. Enter "USB Update Tool" as the keyword.
  - The display lists the available software.
3. Download the file in the desired language.
4. Connect the device to the PC using a USB cable (type A/B).
5. Start the USB Update Tool.
6. Select the COM interface from the selection list.
7. Click on "Connect".
8. Go to the "Release Notes" tab.
  - You will find the change log here.
9. Go to the "Manage Parameters" tab.
  - We recommend that you store the parameters here before performing an update.
10. Go to the "Manage Firmware" tab.
11. Select the firmware.
  - <Load from disk> (local file) or <Load from server> (server connection).
12. Click on "Update".
  - After the update, the status message "Firmware successfully updated!" appears at the bottom edge of the window.
13. If the update was not successful, repeat the procedure.
14. Go to the "Manage Parameters" tab.
15. Write the parameters back to the device.



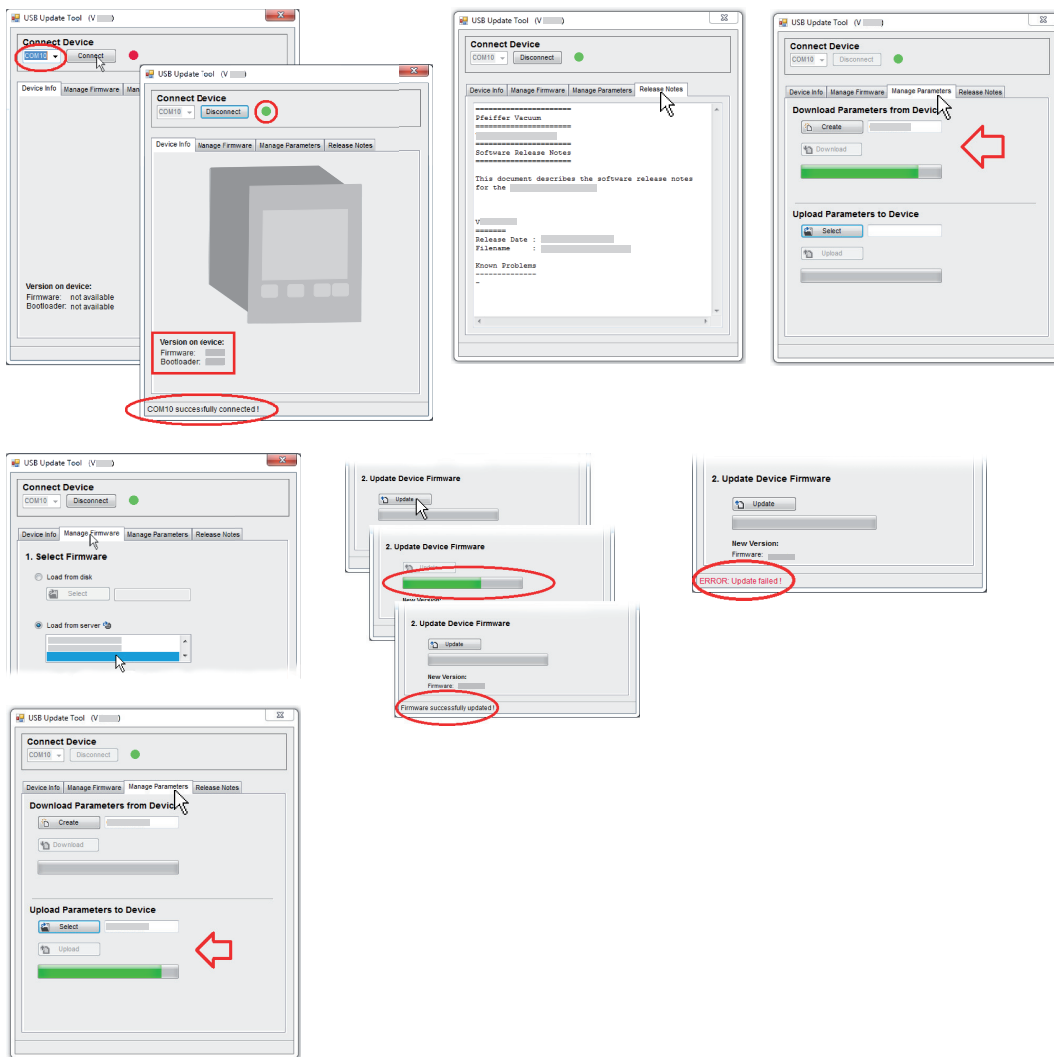

Fig. 38: USB Update Tool

## 12 Malfunctions

The error appears and the error relay opens ("CONTROL" connection).



### Error cannot be eliminated

If the error persists even after it has been acknowledged and/or the gauge has been replaced several times, contact your nearest Pfeiffer Vacuum Service Center.

Error	Possible cause	Remedy/acknowledgment
Display: <b>SENSOR ERROR</b>	Interruption or interference in the connection to the gauge (sensor error).	Acknowledge with the "Parameter" button. If the cause is not remedied, <b>NO SENSOR</b> or <b>NO IDENT</b> appears.
Display: <b>WATCH-DOG ERROR</b>	After switching off, the unit was switched on again too quickly.	Acknowledge with the "Parameter" button. If the watchdog is set to Auto, the device self-acknowledges after 2 s.
	The watchdog was tripped by a serious electrical fault or operating system error.	
Display: <b>UART ERROR</b>	Error in the UART.	Acknowledge with the "Parameter" button.
Display: <b>PROGRAM CORRUPT</b>	Error in program memory (FLASH).	Acknowledge with the "Parameter" button.
Display: <b>DATA CORRUPT</b>	Error in the parameter memory (EEPROM).	Acknowledge with the "Parameter" button.
Display: <b>DISPLAY ERROR</b>	Error in the display driver.	Acknowledge with the "Parameter" button.
Display: <b>FATAL ERROR</b>	General, serious error	Acknowledge with the "Parameter" button.

Tbl. 29: Malfunctions

## 13 Shipping

### **WARNING**

#### **Risk of poisoning from contaminated products**

Where products that contain harmful substances are shipped for maintenance or repair purposes, the health and safety of service personnel is at risk.

- ▶ Comply with the instructions for safe distribution.



#### **Decontamination subject to charge**

Pfeiffer Vacuum decontaminates products not clearly declared "Free of contamination" at your expense.

#### **Ship product safely**

- ▶ Do not ship microbiological, explosive or radioactively contaminated products.
- ▶ Observe the shipping guidelines for the participating countries and transport companies.
- ▶ Highlight any potential dangers on the outside of the packaging.
- ▶ Download the explanation for contamination at [Pfeiffer Vacuum Service](#).
- ▶ Always enclose a completed declaration of contamination.

## 14 Recycling and disposal

### **WARNING**

#### **Health hazard through poisoning from toxic contaminated components or devices**

Toxic process media result in contamination of devices or parts of them. During maintenance work, there is a risk to health from contact with these poisonous substances. Illegal disposal of toxic substances causes environmental damage.

- ▶ Take suitable safety precautions and prevent health hazards or environmental pollution by toxic process media.
- ▶ Decontaminate affected parts before carrying out maintenance work.
- ▶ Wear protective equipment.



#### **Environmental protection**

You **must** dispose of the product and its components in accordance with all applicable regulations for protecting people, the environment and nature.

- Help to reduce the wastage of natural resources.
- Prevent contamination.



#### **Environmental protection**

The product and its components **must be disposed of in accordance with the applicable regulations relating to environmental protection and human health**, with a view to reducing natural resource wastage and preventing pollution.

### 14.1 General disposal information

Pfeiffer Vacuum products contain materials that you must recycle.

- ▶ Dispose of our products according to the following:
  - Iron
  - Aluminium
  - Copper
  - Synthetic
  - Electronic components
  - Oil and fat, solvent-free
- ▶ Observe the special precautionary measures when disposing of:
  - Fluoroelastomers (FKM)
  - Potentially contaminated components that come into contact with media

### 14.2 Dispose of a total pressure measuring and control unit

Pfeiffer Vacuum total pressure measuring and control units contain materials that you must recycle.

1. Dismantle the electronic components.
2. Separate the components into recyclable materials.
3. Recycle the components.
4. Dispose of the product or components in a safe manner according to locally applicable regulations.

## 15 Service solutions by Pfeiffer Vacuum

### We offer first-class service

High vacuum component service life, in combination with low downtime, are clear expectations that you place on us. We meet your needs with efficient products and outstanding service.

We are always focused on perfecting our core competence – servicing of vacuum components. Once you have purchased a product from Pfeiffer Vacuum, our service is far from over. This is often exactly where service begins. Obviously, in proven Pfeiffer Vacuum quality.

Our professional sales and service employees are available to provide you with reliable assistance, worldwide. Pfeiffer Vacuum offers an entire range of services, from [original replacement parts](#) to [service contracts](#).

### Make use of Pfeiffer Vacuum service

Whether preventive, on-site service carried out by our field service, fast replacement with mint condition replacement products, or repair carried out in a [Service Center](#) near you – you have various options for maintaining your equipment availability. You can find more detailed information and addresses on our homepage, in the [Pfeiffer Vacuum Service](#) section.

**You can obtain advice on the optimal solution for you, from your [Pfeiffer Vacuum representative](#).**

**For fast and smooth service process handling, we recommend the following:**



1. Download the up-to-date form templates.
  - [Explanations of service requests](#)
  - [Service requests](#)
  - [Contamination declaration](#)



- a) Remove and store all accessories (all external parts, such as valves, protective screens, etc.).
  - b) If necessary, drain operating fluid/lubricant.
  - c) If necessary, drain coolant.
2. Complete the service request and contamination declaration.



3. Send the forms by email, fax, or post to your local [Service Center](#).



4. You will receive an acknowledgment from Pfeiffer Vacuum.

PFEIFFER VACUUM

### Submission of contaminated products

No microbiological, explosive, or radiologically contaminated products will be accepted. Where products are contaminated, or the contamination declaration is missing, Pfeiffer Vacuum will contact you before starting service work. Depending on the product and degree of pollution, **additional decontamination costs** may be incurred.

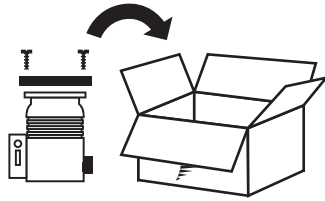

5. Prepare the product for transport in accordance with the provisions in the contamination declaration.
  - a) Neutralize the product with nitrogen or dry air.
  - b) Seal all openings with blind flanges, so that they are airtight.
  - c) Shrink-wrap the product in suitable protective foil.
  - d) Package the product in suitable, stable transport containers only.
  - e) Maintain applicable transport conditions.

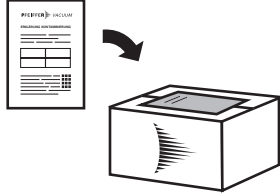

6. Attach the contamination declaration to the **outside** of the packaging.

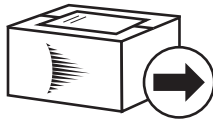

7. Now send your product to your local Service Center.

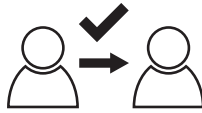

8. You will receive an acknowledgment/quotation, from Pfeiffer Vacuum.

PFEIFFER VACUUM

Our sales and delivery conditions and repair and maintenance conditions for vacuum devices and components apply to all service orders.

## 16 Accessories



View the [range of accessories for ModuLLine](#) on our website.

### 16.1 Accessory information

#### Measuring boards

For the connection of Pirani gauges (TPR) and cold cathode gauges (IKR) for measuring atmospheric pressure (TPR) up to UHV (IKR)

#### Interface boards

Serial and fieldbus interfaces with switchpoints with contacts of varying loading capacity

#### Measurement cable and extension measurement cable

Measurement cable in standard and high temperature versions in different lengths, for connecting to a Pfeiffer Vacuum total pressure measuring and control unit or an ionization measuring device

#### Dummy plates

Cover plate for free slots on Pfeiffer Vacuum total pressure measuring and control units that are not fully configured

### 16.2 Ordering accessories

Description	Order number
Pirani measuring board PI 300 D, for 2 TPR 010/018	PT 546 920 -T
Pirani measuring board PI 300 DN, for 2 TPR 017	PT 549 214 -T
Cold cathode measuring board PE 300 DC9, for 2 IKR 050	PT 441 375 -T
Pirani/cold cathode measuring board CP 300 C9, for 1 TPR 010/018, 1 IKR 050	PT 441 000 -T
Pirani/cold cathode measuring board CP 300 C10, for 1 TPR 010/018, 1 IKR 060	PT 441 114 -T
Pirani/cold cathode measuring board CP 300 T11, for 1 TPR 010/018, 1 IKR 070	PT 441 080 -T
Pirani/cold cathode measuring board CP 300 T11L, for 1 TPR 010/018, 1 IKR 070	PT 441 120 -T

**Tbl. 30: Measuring boards**

Description	Order number
Interface board and relay board IF 300 A, RS-232-C, 45 W, 75 VA	PT 441 130 -T
Interface board and relay board IF 300 B, RS-232-C, 120 W, 1000 VA	PT 441 250 -T
Interface board and relay board IF 300 C, RS-422, 50 V AC / DC	PT 441 390 -T
Interface board and relay board IF 300 P, Profibus-DP, 45 W, 75 VA	PT 441 395 -T
Interface board and relay board IF 500 PN, Profinet	PT 441 595 -T

**Tbl. 31: Interfaces and relay boards**

Description	Order number
Dummy plate, for interface board	PT 441 017
Dummy plate, for measurement board	PT 441 259

**Tbl. 32: Dummy plates**

# 17 Technical data and dimensions

## 17.1 General

	mbar	bar	Pa	hPa	kPa	Torr   mm Hg
mbar	1	$1 \cdot 10^{-3}$	100	1	0.1	0.75
bar	1000	1	$1 \cdot 10^5$	1000	100	750
Pa	0.01	$1 \cdot 10^{-5}$	1	0.01	$1 \cdot 10^{-3}$	$7.5 \cdot 10^{-3}$
hPa	1	$1 \cdot 10^{-3}$	100	1	0.1	0.75
kPa	10	0.01	1000	10	1	7.5
Torr   mm Hg	1.33	$1.33 \cdot 10^{-3}$	133.32	1.33	0.133	1

$1 \text{ Pa} = 1 \text{ N/m}^2$

**Tbl. 33: Conversion table: Pressure units**

	mbar l/s	Pa m³/s	sccm	Torr l/s	atm cm³/s
mbar l/s	1	0.1	59.2	0.75	0.987
Pa m³/s	10	1	592	7.5	9.87
sccm	$1.69 \cdot 10^{-2}$	$1.69 \cdot 10^{-3}$	1	$1.27 \cdot 10^{-2}$	$1.67 \cdot 10^{-2}$
Torr l/s	1.33	0.133	78.9	1	1.32
atm cm³/s	1.01	0.101	59.8	0.76	1

**Tbl. 34: Conversion table: Units for gas throughput**

## 17.2 Technical data

Parameter	Value
Usage	<ul style="list-style-type: none"> <li>• Rack installation</li> <li>• Switchboard installation</li> <li>• Desktop unit</li> </ul>
Weight	< 1.45 kg

**Tbl. 35: General technical data**

Parameter	Value
Voltage	100 to 240 V (AC) ± 10 %
Frequency	50 to 60 Hz
Power consumption	≤ 65 W
Overvoltage category	II
Protection class	1
Connection	Connector socket IEC 320 C14
Fuse	Integrated (not accessible)

**Tbl. 36: Mains connection**

Parameter	Value
Installation location	weatherproof (internal space)
Ambient temperature (storage)	-20 to 60 °C
Ambient temperature (operation)	5 to 50 °C
Relative humidity of air	≤ 80 % to +31 °C, decreasing to 50 % at +40 °C
Installation altitude	max. 2,000 m above sea level



Parameter	Value
Degree of pollution	II
Protection degree	IP30

**Tbl. 37: Ambient conditions**

Parameter	Value
Quantity, number	2 for measuring boards (A and B) 1 for interface board and relay board (C)
Connectable measuring boards <sup>13)</sup>	Pirani: PI 300 D, PI 300 DN Cold cathode: PE 300 DC9 Pirani/cold cathode: CP 300 C9, CP 300 C10, CP 300 T11, CP 300 T11L
Connectable interface boards <sup>14)</sup>	RS-232-C/relay: IF 300A, IF 300B RS-422/relay: IF 300 C Profibus/relay: IF 300 P Profinet, IF 500 PN

**Tbl. 38: Plug-in positions for plug-in boards**

Parameter	Value
Front panel	4 control buttons
Remote control	<ul style="list-style-type: none"> <li>• RS-485 interface</li> <li>• USB type B interface</li> <li>• Ethernet interface</li> </ul>

**Tbl. 39: Operation**

Parameter	Value
Measuring ranges	Gauge-dependent
Measuring rate, analog	$\geq 100 / \text{s}$
Display rate	$\geq 10 / \text{s}$
Measured value filter (limit frequency)	OFF, 100 Hz, 10 Hz (ex factory), 1 Hz, 0,1 Hz
Unit of measurement	hPa, mBar, Torr, Pa, Micron, V, A

**Tbl. 40: Measured values**

Parameter	Value
Quantity, number	4 freely selectable switch-points
Response time	$\leq 10 \text{ ms}$
Setting range	Gauge-dependent
Hysteresis	$\geq 10 \%$ of the measured value

**Tbl. 41: Switching functions**

Parameter	Value
Switching function relay	4
Error relay	1
Contact type	Zero-potential two-way contact

13) Refer to the operating instructions for BG 5972 (plug-in boards)

14) Refer to the operating instructions for BG 5972 (plug-in boards)

Parameter	Value
Load max.	60 V (DC), 0.6 A (ohmic) 40 V (AC), 1 A (ohmic) 30 V (DC), 1.5 A (ohmic) 30 V (AC), 1.5 A (ohmic)
Service life (mechanical)	1 × 10 <sup>8</sup> switching cycles
Service life (electrical)	1 × 10 <sup>5</sup> switching cycles (with maximum load)
Connection	D-Sub socket, 25-pole

**Tbl. 42: Relay contacts**

Parameter	Value
Quantity, number	4
Voltage range	0 to +5 V (DC) 0 to +10 V (DC) ± 1 % (typically ± 0.2 %)
Current range	4 to 20 mA ± 1 % (typically ± 0.2 %)
Resolution	16 bit
Output resistance	< 50 Ω (typically 47.5 Ω)
Response time	≤ 10 ms
Connection	D-Sub socket, 25-pole

**Tbl. 43: Reversible analog outputs**

Parameter	Value
Protocol	ASCII, addressable (RS485), Mnemonics protocol or Pfeiffer Vacuum protocol
Data format	Two-way data traffic, 1 start bit, 8 data bits, 1 stop bit, no parity bit, no handshake
Baud rate	9600, 19200, 38400, 57600, 115200
Connection	Binder M12 connector, 5-pole, A-coded

**Tbl. 44: RS-485 interface**

Parameter	Value
Protocol	FAT file system File processing in ASCII format

**Tbl. 45: USB interface (type A)**

Parameter	Value
Protocol	ASCII, Mnemonics protocol or Pfeiffer Vacuum protocol
Baud rate	9600, 19200, 38400, 57600, 115200

**Tbl. 46: USB interface (type B)**

Parameter	Value
Protocol	Mnemonics protocol or Pfeiffer Vacuum protocol
Configuration	

**Tbl. 47: Ethernet interface**

## 17.3 Dimensions

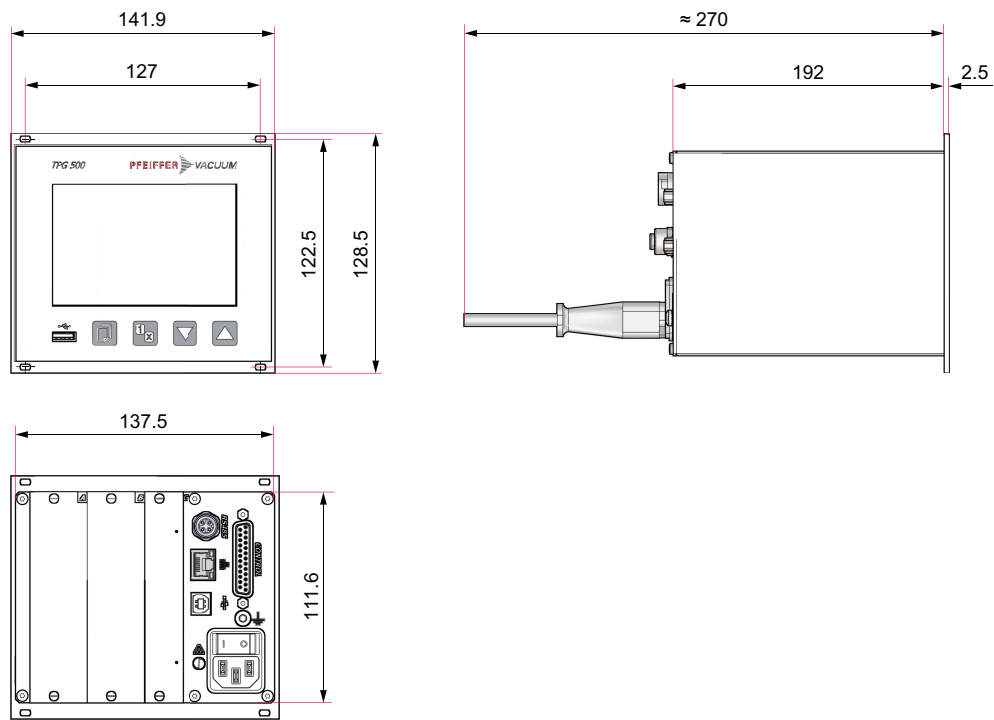

**Fig. 39: Dimensions**  
Dimensions in mm



**Intertek**  
4010094

## ETL LISTED

The product TPG 500

- conforms to the following UL standards

**UL 61010-1:2012 Ed. 3 + R:21 Nov 2018**

Safety requirements for electrical equipment for measurement, control and laboratory use  
Part 1: General requirements

**UL 61010-2-030:2012 Ed. 1 + R:16 Sep 2016**

Safety requirements for electrical equipment for measurement, control and laboratory use  
Part 2-030: Particular requirements for testing and measuring circuits

- is certified to the following CAN/CSA standards

**CAN/CSA-C22.2 No. 61010-1-12:2012 Ed. 3 + U1; U2; A1**

Safety requirements for electrical equipment for measurement, control and laboratory use  
Part 1: General requirements

**CAN/CSA-C22.2 No. 61010-2-030:2018 Ed. 2**

Safety requirements for electrical equipment for measurement, control and laboratory use  
Part 2-030: Particular requirements for testing and measuring circuits

# Declaration of Conformity

Declaration for product(s) of the type:

**Total pressure measuring and control unit**

TPG 500

We hereby declare that the listed product satisfies all relevant provisions of the following **European Directives**.

**Basse tension 2014/35/CE**

**Electromagnetic compatibility 2014/30/EU**

**Restriction of the use of certain hazardous substances 2011/65/EU**

**Restriction of the use of certain hazardous substances, delegated directive 2015/863/EU**

**Harmonized standards and applied national standards and specifications:**

DIN EN 61000-3-2:2015-03

DIN EN 61000-3-3:2014-03

DIN EN 61000-6-1:2007-10

DIN EN 61000-6-2:2006-03

DIN EN 61000-6-4:2011-09

DIN EN 61010-1:2011-07

DIN EN 61010-2-030:2011-07

DIN EN 61326-1:2013-07

---

Signature:



(Daniel Sälzer)  
Managing Director

Pfeiffer Vacuum GmbH  
Berliner Straße 43  
35614 Asslar  
Germany

---

Asslar, 2022-05-01



## VACUUM SOLUTIONS FROM A SINGLE SOURCE

Pfeiffer Vacuum stands for innovative and custom vacuum solutions worldwide, technological perfection, competent advice and reliable service.

## COMPLETE RANGE OF PRODUCTS

From a single component to complex systems:

We are the only supplier of vacuum technology that provides a complete product portfolio.

## COMPETENCE IN THEORY AND PRACTICE

Benefit from our know-how and our portfolio of training opportunities!

We support you with your plant layout and provide first-class on-site service worldwide.

ed. B - Date 2206 - P/N:BG6008BEN



Are you looking for a  
perfect vacuum solution?  
Please contact us

Pfeiffer Vacuum GmbH  
Headquarters • Germany  
T +49 6441 802-0  
info@pfeiffer-vacuum.de

[www.pfeiffer-vacuum.com](http://www.pfeiffer-vacuum.com)

**PFEIFFER**  **VACUUM**