



Ball valve, manual, DN 10 ISO-KF



Similar Image

Ball valve, manual, DN 10 ISO-KF

- Ball valve with large-scale free clearance
- Ball made from stainless steel (1.4401)

Dimensions

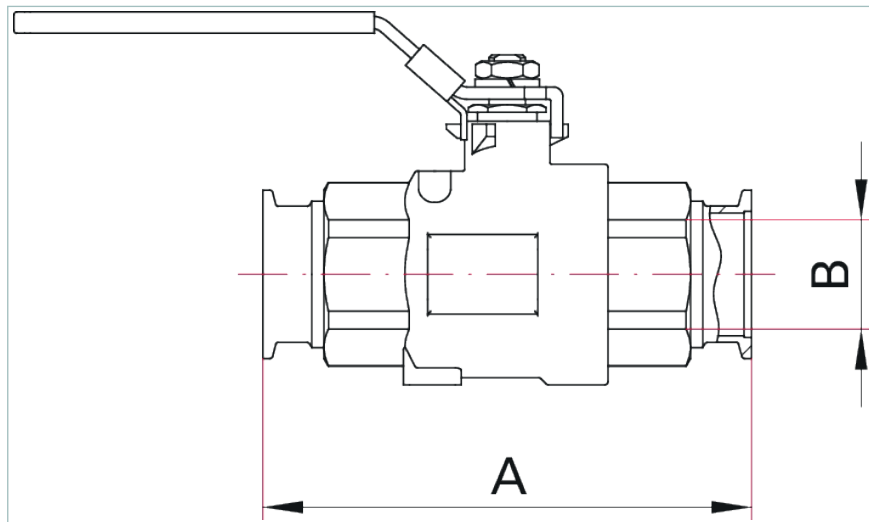

A	100 mm
B	10 mm

Technical Data	Ball valve, manual, DN 10 ISO-KF
Actuator	90° turning of handle
Flange, Material	Stainless steel 1.4301
Housing	Stainless steel 1.4408
Nominal diameter	DN 10 ISO-KF
Pressure range	$1 \cdot 10^{-5}$ hPa to 500 hPa over pressure
Seal	PTFE (glass fiber reinforced)
Service life	20000 Cycles
Temperature range	-20 to 80 °C
Tightness	$< 1 \cdot 10^{-7}$ Pa m ³ /s
Type	Ball valve

Order number	
Ball valve	120VKZ010

VACUUM SOLUTIONS FROM A SINGLE SOURCE

Pfeiffer Vacuum stands for innovative and custom vacuum solutions worldwide, technological perfection, competent advice and reliable service.

COMPLETE RANGE OF PRODUCTS

From a single component to complex systems:

We are the only supplier of vacuum technology that provides a complete product portfolio.

COMPETENCE IN THEORY AND PRACTICE

Benefit from our know-how and our portfolio of training opportunities!

We support you with your plant layout and provide first-class on-site service worldwide.

Are you looking for a
perfect vacuum solution?
Please contact us:

Pfeiffer Vacuum GmbH
Headquarters · Germany
T +49 6441 802-0
info@pfeiffer-vacuum.de

www.pfeiffer-vacuum.com

All data subject to change without prior notice.

PFEIFFER  **VACUUM**