



# ELD500 LEAK DETECTOR INSTRUCTION MANUAL

Publication number: D135-10-880

Issue: B

Original Instructions

## **Copyright notice**

© Edwards Limited 2017. All rights reserved.

## **Trademark credits**

Edwards and the Edwards logo are trademarks of Edwards Limited.

## Declaration of Conformity

Edwards Ltd,  
Innovation Drive,  
Burgess Hill,  
West Sussex,  
RH15 9TW, UK

The following product

Leak detection system – ELD500:

ELD500 WET, 220 to 240 V, 50/60 Hz	D13510903
ELD500 WET, 100 to 120 V, 50/60 Hz	D13510904
ELD500 WET, 105 V, 60 Hz	D13510906
ELD500 DRY, 220 to 240 V, 50/60 Hz	D13520903
ELD500 DRY, 100 to 120 V, 50/60 Hz	D13520904
ELD500 DRY, 105 V, 60 Hz	D13520906
ELD500 FLEX	D13530000

Is in conformity with the relevant requirements of European CE legislation:

2006/42/EC	Machinery Directive
2014/35/EU	Low Voltage Directive
2014/30/EU	Electromagnetic Compatibility (EMC) Directive
2011/65/EU	Restriction of Certain Hazardous Substances (RoHS) Directive

Based on the relevant requirements of harmonised standards:

EN61010-1:2010	Safety requirements for electrical equipment for measurement, control and laboratory use. General requirements
EN61326-1:2013	Electrical equipment for measurement, control and laboratory use. EMC requirements. General requirements Class A, Industrial Immunity

The product also complies with the following:

2012/19/EU	Waste from Electrical and Electronic Equipment (WEEE) Directive
------------	---

*This covers all product serial numbers from the date of this Declaration onwards.*



Peter Lamb  
Senior Manager, Scientific Pump Technology

30.11.2017, Burgess Hill

Date and Place

This page has been intentionally left blank.

# Contents

<b>Safety</b>	<b>1</b>
Key to the symbols .....	1
Symbols of vacuum technology .....	3
Definition of terms .....	3
<b>Description</b>	<b>5</b>
Design and function .....	5
Vacuum diagram ELD500 WET .....	5
Vacuum diagram ELD500 DRY .....	7
Vacuum diagram ELD500 FLEX .....	8
Vacuum method .....	9
Partial flow method .....	9
Sniffer mode .....	10
Supplied equipment .....	10
Technical data .....	10
Technical data ELD500 WET .....	10
Physical data .....	10
Electrical data .....	11
Other data .....	11
Environmental conditions .....	12
Technical data ELD500 DRY .....	12
Physical data .....	12
Electrical data .....	13
Other data .....	13
Ambient conditions .....	13
Technical data ELD500 FLEX .....	14
Physical data .....	14
Electrical data .....	14
Other data .....	15
Environmental conditions .....	15
Dimensional drawings .....	15
Ordering information .....	17
Accessories .....	18
Sniffer line (ELD500 SL) .....	18
Remote control RC wired and RC wireless .....	19
Partial flow adaptor (ELD500) .....	19
Default settings .....	19
<b>Installation</b>	<b>21</b>
Placement .....	21
Conforming utilisation .....	21
Ambient conditions .....	21
Electrical connections .....	22
Mains power .....	22
Connection for the controller signal and accessories .....	23
Option (accessories) .....	23

Digital out (CONTROL) .....	23
Digital in (Control 2) .....	23
Recorder/RECORD .....	24
SERIAL/RS232 .....	24
Remote control (REMOTE1) .....	25
Remote control (REMOTE2) .....	25
CHARGE .....	26
Vacuum connections .....	26
Inlet port .....	26
Exhaust .....	26
Vent .....	26
Gas ballast connection .....	26
Connection of an external pump (only ELD500 FLEX) .....	26

## **Operation** **29**

Media compatibility/purge gas .....	29
Start-up .....	29
Display .....	29
The Display in run-up mode .....	30
The display in standby mode .....	30
Gas ballast/purge .....	30
The display in measurement mode .....	30
Call for calibration .....	31
Speaker volume .....	31
Status line in the display .....	31
Measurement mode with bar graph .....	32
Measurement mode with trend information .....	32
First operation check .....	32
Needed equipment .....	32
Start-up and measure .....	32
Internal calibration .....	33
Verification with an external test leak .....	33
Measure with a test object .....	34
Switch off .....	34
Control panel .....	34
Softkeys .....	36
Special functions .....	36
Numerical entries .....	36
Interfaces .....	38
Location of control .....	38
Define recorder output .....	39
RS232 .....	41
Define PLC outputs .....	41
Define PLC inputs .....	42
Scaling recorder output .....	44
PLC sample rate .....	44
Operation .....	44
Main menu .....	45
View .....	47
Scale linear/logarithmic .....	47

Display-range auto/manual .....	48
Time axis .....	48
Contrast .....	49
Background in standby .....	49
Lower display limit .....	50
Mode .....	50
Trigger and alarms .....	51
Trigger level 1 .....	51
Trigger level 2 .....	52
Trigger level 3 .....	52
Units .....	52
Volume .....	53
Alarm delay .....	53
Audio alarm type .....	54
Pinpoint .....	54
Leak rate prop. ....	54
Setpoint .....	54
Trigger alarm .....	55
Calibration .....	55
Settings .....	55
Vacuum settings .....	56
ELD500 WET .....	56
ELD500 DRY .....	57
ELD500 FLEX .....	57
Automatic purge .....	58
Vent delay .....	58
Vacuum ranges ELD500 DRY/ELD500 FLEX .....	59
Vacuum ranges ELD500 DRY .....	59
Partial flow setup/pump setup .....	60
Enable partial flow mode .....	60
Partial flow setup for the ELD500 WET/DRY .....	60
Partial flow setup ELD500 FLEX .....	61
Vacuum settings ELD500 FLEX .....	61
Partial flow setup for the ELD500 FLEX .....	62
Sniffer factor .....	63
SL extender interface setting .....	63
Machine factor .....	63
Leak rate internal test leak .....	64
Purge in measurement .....	64
Filter and background .....	64
Calculate inlet area background .....	65
Background suppression .....	65
Leak rate filter .....	65
Mass .....	66
Miscellaneous (language, calibration request, service interval...) .....	66
Time and date .....	67
Language .....	67
Calibration request .....	67
Service interval fore-pump .....	67
Service interval exhaust oil filter .....	68
Service message exhaust oil filter .....	68

Parameter save/load .....	68
Load parameter set .....	69
Save parameter set .....	69
Monitoring functions .....	69
Maximum evacuation time .....	69
Contamination protection .....	70
Pressure limits for vacuum mode. ....	71
Pressure limits for sniff mode .....	72
Information .....	72
Service .....	73
Access control .....	73
Zero .....	74
Access to CAL function .....	74
Change menu-PIN .....	75
Calibration .....	75
Introduction .....	75
The calibration routines .....	75
Internal calibration .....	75
External calibration .....	76
Factor of calibration - range of values .....	78
Switching off/shutting down .....	78
<b>Maintenance</b> .....	<b>79</b>
Safety information .....	79
Maintenance intervals .....	79
Service .....	79
Maintenance work .....	80
Opening of the ELD500 .....	80
Exchanging the filter mats .....	81
Exchanging the oil .....	81
Oil change .....	82
Cleaning .....	83
Exchanging the fuses .....	83
Exhaust oil filter .....	85
Turbomolecular pump .....	85
Calibrated leak TL7 .....	85
Technical data .....	85
Factory inspection .....	85
<b>Troubleshooting</b> .....	<b>87</b>
Hints for troubleshooting .....	87
List of errors and warnings .....	87
<b>Waste disposal</b> .....	<b>97</b>



# List of Figures

View of the ELD500 .....	5
Vacuum diagram ELD500 .....	6
Vacuum diagram ELD500 DRY .....	7
Vacuum diagram ELD500 FLEX .....	8
Dimensions ELD500 .....	15
Dimensions ELD500 side view .....	16
Dimensions ELD500 FLEX .....	17
Remote control RC wireless .....	19
Side views of the ELD500 .....	22
Display: measurement mode with bar graph .....	31
Display: measurement mode with bar graph .....	32
Control panel .....	34
Zero activation .....	35
Undo zero .....	36
Numerical entry of the trigger level, sample of the digit .....	37
Trigger level, change of the first digit .....	37
Recorder output: Pirani ELD500, P1 and P2 .....	39
Recorder output: P1 and P2 Legacy .....	40
Recorder output: Leak rate exponent .....	40
Recorder output: Leak rate mantissa .....	40
Recorder output: Leak rate logarithmic, default setting .....	40
Display: main menu .....	45
Overview menu structure .....	46
Display: view menu .....	47
Display: mode menu .....	50
Display: trigger and alarms menu .....	51
Pinpoint: change of the frequency in the leak rate window (TR1=Triggerlevel 1) ..	54
Setpoint: change of the frequency above the trigger level 1 (TR1= Trigger level 1)	55
Display: calibration menu .....	55
Display: settings menu .....	56
Display: information menu .....	72
Display: access control menu .....	73
Display: external calibration, Step 1 .....	76
Display: external calibration, Step 2 .....	76
Display: external calibration, Step 3 .....	76
Display: external calibration, Step 4 .....	77
Display: external calibration, Step 5 .....	77
Display: external calibration, Step 6 .....	77
Display: external calibration, Step 7 .....	77
Back view of the ELD500 .....	80
Opening of the mechanical hood .....	80
Assembly fuses .....	84

## List of Tables

ELD500 WET physical data .....	10
ELD500 WET electrical data .....	11
ELD500 WET other data .....	11
ELD500 WET environmental conditions .....	12
ELD500 DRY physical data .....	12
ELD500 DRY electrical data .....	13
ELD500 DRY other data .....	13
ELD500 DRY ambient conditions .....	13
ELD500 FLEX physical data .....	14
ELD500 FLEX electrical data .....	14
ELD500 FLEX other data .....	15
ELD500 FLEX environmental conditions .....	15
Option (accessories) connector pin-outs .....	23
Digital out (CONTROL) connector pin-outs .....	23
Digital in (Control 2) connector pin-outs .....	24
Recorder/RECORD connector pin-outs .....	24
SERIAL/RS232 connector pin-outs .....	25
Remote control (REMOTE1) connector pin-outs .....	25
Remote control (REMOTE2) connector pin-outs .....	25
Status line symbol meanings .....	31
PLC outputs .....	41
PLC inputs .....	43
Fault finding .....	88

# Safety

## Key to the symbols

Important instructions relating to technical safety and safe operation are emphasised by symbols.

**WARNING:**



Warnings are given where failure to observe the instruction could result in injury or death to people.

**CAUTION:**



Cautions are given where failure to observe the instruction could result in damage to the equipment, associated equipment and process.









**Note:**

*Emphasizes additional application information and other useful information provided within these operating instructions.*

The Edwards ELD500 leak detector has been designed for safe and efficient operation when used properly and in accordance with these operating instructions. It is the responsibility of the user to carefully read and strictly observe all safety precautions described in this section and throughout the Operating Instructions. The ELD500 must only be operated in the proper condition and under the conditions described in the Operating Instructions. It must be operated and maintained by trained personnel only. Consult local, state, and national agencies regarding specific requirements and regulations. Address any further safety, operation and/or maintenance questions to our nearest office.

Failure to observe the following precautions could result in serious personal injury.

	<p>During all maintenance and connection work, ensure the mains cable has been disconnected and does not carry a mains voltage. The leak detector must only be used with the hoods closed. The electrical connections must only be provided by a trained electrician as specified, for example, by the regulations EN 50110-1.</p>
	<p>Avoid exposing any part of the human body to the vacuum. Only handle the leak detector when the pump is vented.</p>
	<p>After a mains power failure the leak detector can run up automatically once more. Before changing oil or fuses, make sure that the mains cable have been disconnected.</p>
	<p>The leak detector is not suited for operation in explosion hazard areas.</p>
	<p>During operation the pump can become so hot that there is a danger of burns (&gt; 70 °C (158 °F)). Provide protection against contact with the hot components.</p>
	<p>Contaminated parts can be detrimental to health and environment. Before beginning to work, find out whether any parts are contaminated. Adhere to the relevant regulations and take the necessary precautions when handling contaminated parts.</p>

Failure to observe the following precautions could result in damage to the pump.

- Unauthorized opening or modifications of the mechanical or electrical components of the leak detector void the warranty.
- The leak detector must only be opened by such persons who have been authorised by Edwards.
- The leak detector can be damaged when using the wrong voltage. The voltage must be in the range 230 V (+/- 5%) or 115 V (+/- 5%) depending on the leak detector version. Make sure that the mains voltage rating on the ELD500 coincides with the locally available mains voltage.
- When the ELD500 is running in closed rooms the exhaust has to be put out of doors so that the oil vapour can not be breathed in.
- Ensure a sufficient air cooling. The air inlet as well the air discharge openings must never be obstructed.
- The ELD500 is designed for indoor use only.
- Operate the ELD500 only in the permitted temperature range between +10 °C and +40 °C.
- Only Ultragrade 15 (H11026015) must be used in the wet pump.

Pumping condensable gases and steams: When pumping test sample water vapour that is inside the test object can attain to the fore-pump. With the water vapour that is in the air - especially in humid areas or when using humid or wet test samples - the acceptable compatibility of water vapour or capacity of water vapour respectively can be exceeded.

The steam in the oil of the pump condenses when the water vapour rises over the acceptable value. So the attribute of the oil changes and danger of corrosion occurs for the pump.

While using the leak detector with condensable gases and steams the oil of the fore-pump has to be controlled regularly. So condensation of water vapour in the pump can be recognized. Usually the oil is light and lucent. When water vapour is inside it gets blear and milky at operating state temperature.

When turning the pump off water vapour condensates and raises the part of water in the oil.

The leak detector must not directly be switched off after the process, in which condensable gases or steams are pumped, is finished. It must be running (at least 20 minutes) with opened gas ballast valve until the oil of the pump is freed from detached steam.





When not taking care of this instruction there can be a corrosion within the pump, which will not be covered by our warranty.

The height of the oil of the pump has to be controlled regularly.

The normal intervals of changing the oil from the producer have to be taken care of. See instructions of the rotary vane pump.

## Symbols of vacuum technology

Given in the following are some important symbols which are used in this instruction manual.

	<b>Vacuum pump in general</b>
	<b>Turbo molecular pump</b>
	<b>Measuring instrument</b>
	<b>Valve</b>

## Definition of terms

Term	Description
Auto ranging	<p>The range of the pre-amplifier and the vacuum ranges are selected automatically.</p> <p>The auto ranging feature of the ELD500 covers the entire range or leak rates depending on the selected operating mode. Not only the leak rate signal, but also the pressure in the test sample (inlet pressure P1) and the fore vacuum pressure (P2) are used for control purposes. Range switching between the main ranges is performed via valves. Fine range switching within the main ranges is implemented by switching over the gain factor of the pre-amplifier.</p>
Mass alignment	<p>This function automatically aligns the mass spectrometer so that a maximum leak rate is displayed. The control processor changes the voltage which accelerates the ions in the selected mass range until a maximum ion current is detected by the ion detector. During each calibration the mass alignment is run automatically.</p>
Auto zero	<p>Determination and automatic adaptation of the internal background.</p> <p>Through this function, the internal zero level of the instrument is determined which is then subtracted from the current leak rate signal. This function is run during the calibration process or when operating the start push button, provided the ELD500 has been running previously for at least 20 seconds in the standby or vent mode.</p>
GROSS	<p>GROSS is a measurement mode which allows high inlet pressure (15 to 0.2 mbar). The smallest detectable leak rate is <math>1 \times 10^{-7}</math> mbar l/s.</p>

Term	Description
FINE	FINE is a measurement mode with inlet pressure < 0.2 mbar. The minimum detectable leak rate is $\leq 5 \times 10^{-12}$ mbar l/s.
PRECISION	Precision is a measurement mode for the ELD500 DRY only from an inlet pressure < 0.01 mbar. In this mode the ELD500 DRY has the highest sensitivity, the minimum detectable leak rate is $\leq 3 \times 10^{-11}$ mbar l/s.
Fore-vacuum pressure	Pressure in the fore vacuum between turbo pump and rotary vane pump.
Internal helium background	The existing helium partial pressure in the measurement system. The level of the internal helium background is measured in the standby mode and subtracted from the measured signal.
Minimum detectable leak rate	The smallest leak rate the ELD500 is able to detect ( $\leq 5 \times 10^{-12}$ mbar l/s) in vacuum mode.
Menu	The menu allows the user to program the ELD500 according to his requirements. The menu has a tree architecture.
Measurement mode	The ELD500 measures the leak rate of the test sample.
Default	Status of the ELD500 when supplied by the factory.

## Description

The ELD500 is a leak detector for helium or hydrogen. This instrument may be used to detect the location and the size of leaks on objects under test in two different ways:

When the test sample has been evacuated first and is sprayed with helium on the outside. It is required that a vacuum connection is provided between the ELD500 and the test sample (vacuum mode).

or

when a helium overpressure is provided in the test sample and the test sample is searched from the outside with a sniffer probe which is attached to the inlet port (sniffer mode).

**Figure 1 View of the ELD500**



1. Inlet flange

2. Control panel

## Design and function

The ELD500 basically is a helium leak detector for vacuum applications, that is, the part under test is evacuated while the test is performed. The vacuum is achieved with a pumping system that is part of the ELD500. In addition the vacuum can be generated by pumps which are set up in parallel to the ELD500.

The ELD500 FLEX needs a fore vacuum pump, dry or wet version, to be connected because this unit has no internal roughing pump. The connection (DN25 KF) is on the side or under the bottom of the ELD500 FLEX (Figure 7).

Another operating mode of the ELD500 is the Sniffer mode which can only be used when a sniffer line (see Sniffer mode) is hooked up.

## Vacuum diagram ELD500 WET

The vacuum diagram below shows the major components inside the ELD500 WET.

Figure 2 Vacuum diagram ELD500

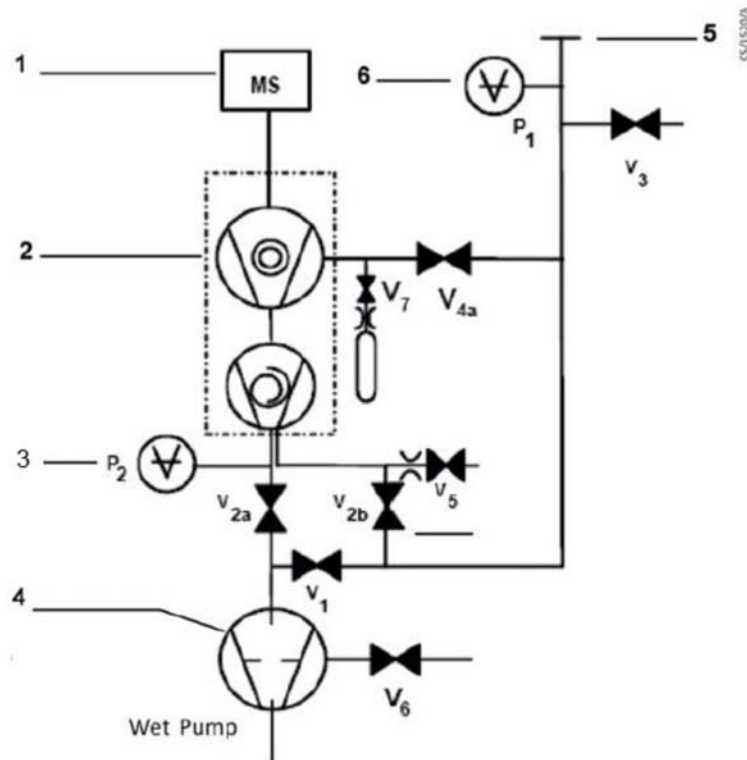

1. MS: Mass Spectrometer, Helium sensor (180° magnetic field mass spectrometer)
2. Turbo molecular pump (TMP, provides high vacuum conditions in the MS)
3. Pirani gauge P2 (fore vacuum pressure)
4. Fore pressure pump (provides the fore vacuum pressure for the TMP and pumps down the parts under test)
5. Inlet Port
6. Pirani gauge P1 (inlet pressure)

V1 to V7: Electromagnetic Valves to control the gas flows

The mass spectrometer (MS) is mainly composed of the ion source with cathode, the magnetic separator and the ion collector.

Gas molecules getting into the mass spectrometer are ionized by the ion source. These positively charged particles are accelerated into the magnetic field following a circular path, the radius of which depends on the mass-to-charge ratio of the ions. When mass 4 is selected (Default setting) only helium ions can pass this filter and reach the ion collector where the stream of the ions is measured as an electrical current. When selected another mass than 4, only the corresponding ions can pass the filter.

For operation the mass spectrometer requires a vacuum level in the range of  $1 \times 10^{-4}$  mbar and lower. This pressure is provided by the turbo molecular pump which in turn is backed up by a fore vacuum pump.

Besides maintaining the pressure in the mass spectrometer the pump system is used to evacuate the test parts. It is made sure that the pressure in the mass spectrometer is low enough under all circumstances. The valves V1, V2a, V2b, V4a control the gas flows when



measuring. Valves V3 and V5 are used to vent the system and the Turbo pump, valve V6 controls the gas ballast function of the fore vacuum pump. Valve V7 opens and closes the internal test leak during calibration.

With the pressure in the test part being lower than ambient pressure sprayed helium (or Hydrogen as forming gas) can penetrate into the part in case of a leakage. As soon as the pressure conditions allow it one of the valves to the TMP opens. Now Helium can penetrate into the mass spectrometer contrary to the pumping direction of the TMP.

### Vacuum diagram ELD500 DRY

The ELD500 DRY has a diaphragm pump as fore vacuum pump, making it suitable for applications where oil sealed systems can not be used. Furthermore the ELD500 DRY contains one more valve, the valve 4b. This valve opens step by step to regulate the inlet pressure into the turbo pump.

**Figure 3 Vacuum diagram ELD500 DRY**

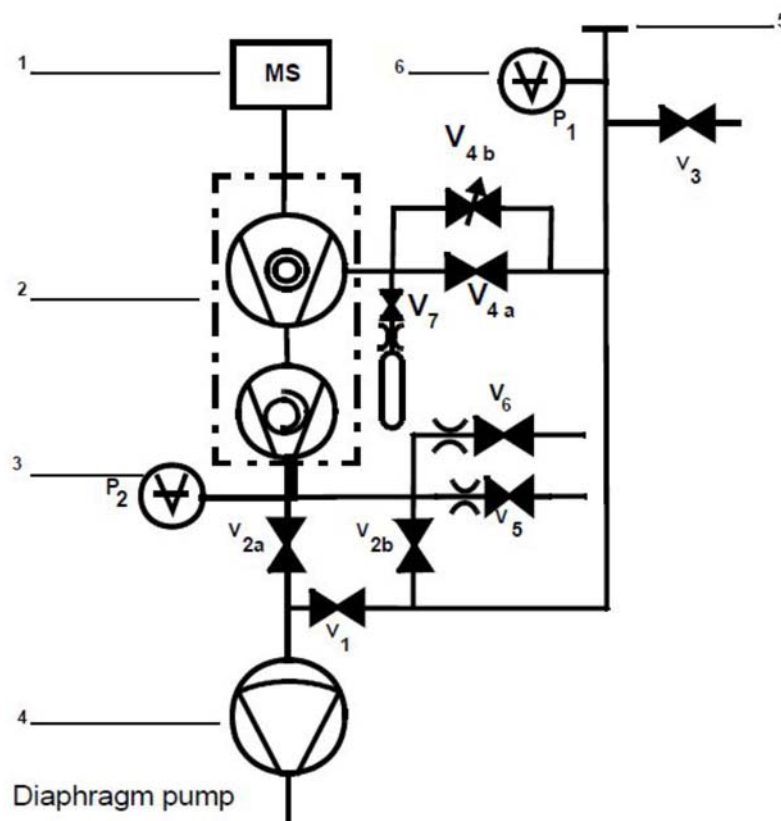

1. MS: Mass Spectrometer, Helium sensor (180° magnetic field mass spectrometer)
2. Turbo molecular pump (TMP, provides high vacuum conditions in the MS)
3. Pirani gauge P2 (fore vacuum pressure)
4. Diaphragm pump (provides the fore vacuum pressure for the TMP and pumps down the parts under test)
5. Inlet Port
6. Pirani gauge P1 (inlet pressure)

V1 to V7: Electromagnetic Valves to control the gas flows

## Vacuum diagram ELD500 FLEX

The ELD500 FLEX has no roughing pump integrated as the other models. Therefore it can be used with an external pump only. This pump can be oil sealed or a dry version with a roughing capacity between 2.5 and 65 m<sup>3</sup>/h. This pump has to be connected to the DN25 KF at the side or under the bottom of the ELD500 FLEX.

Figure 4 Vacuum diagram ELD500 FLEX

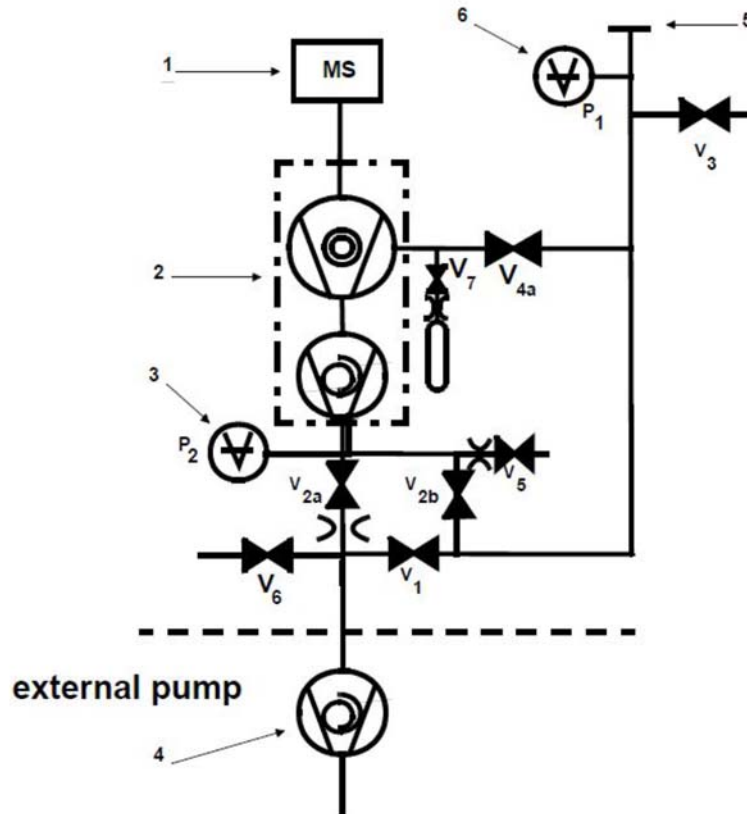

- 1 MS: Mass Spectrometer, Helium sensor (180° magnetic field mass spectrometer)
- 2 Turbo molecular pump (TMP, provides high vacuum conditions in the MS)
- 3 Pirani gauge P2 (fore vacuum pressure)
- 4 Fore pressure pump (provides the fore vacuum pressure for the TMP and pumps down the parts under test)
- 5 Inlet Port
- 6 Pirani gauge P1 (inlet pressure)

V1 to V7: Electromagnetic valves to control the gas flows

## Vacuum method

For the purpose of leak detection on a test sample (vacuum method), the sample has to be evacuated so that Helium or Hydrogen which is sprayed on to the outside, can enter through any leaks due to the pressure differential for detection by the ELD500.

The test sample is evacuated - START button (Figure 16 item 10) - by the backing pump or the external pump. In the case of larger test samples an additional external partial flow pump with a corresponding linking valve may be connected in parallel as required.

Inlet valve V1 is opened so that the evacuation can take place. At the same time all other valves are closed in order to prevent an unacceptable pressure increase in the mass spectrometer.

In this context (valve V2a closed) the turbo molecular pump is operated without being supported by the rotary vane pump. Since generally no gas is pumped out of the mass spectrometer, p2 remains constant or increases only slowly.

The condition for the evacuation process described here is maintained until the inlet pressure p1 has dropped <15 mbar. Now the valves V2a and V2b are opened additionally. Possibly present Helium or Hydrogen may now flow upstream against the pumping direction of the turbo molecular pump into the mass spectrometer where it is detected. This measurement mode is called GROSS. In this mode, leak rates down to  $10^{-8}$  mbar l/s can be detected.

Since the rotary vane vacuum pump continues to evacuate the test sample via valves V2a, V2b and V1 the inlet pressure p1 will continue to drop. When the pressure drops below p1 < 0.2 mbar, the ELD500 will switch to the FINE mode, that is, valve V1 and V2b closes and valve V4a opens so that the gas flow enters the turbo molecular pump at the side. This offer two advantages:

1. A part of the high pumping speed of the turbo molecular pump remains available for further evacuation of the test sample. The response time is inversely proportional to pumping speed.)
2. The advantages offered by the counter flow principle can still be utilized

In the FINE mode the full sensitivity of the ELD500 is reached.

Because of the higher base pressure of the diaphragm pump the switching from GROSS to FINE mode of the ELD500 DRY is done by the valve V4b. When the pressure drops below 3.5 mbar the valves V1 and V2b will be close and V4b opens step by step. When valve V4b is open completely, pressure < 0.1 mbar, V4a will open also to get the maximum pumping speed. In PRECISION mode the ELD500 DRY opens the valve V4b only, with the disadvantage of low pumping speed but with the highest sensitivity.

When the leak detection process is stopped – STOP-button – all valves except valve V2a are closed.

Valve V3 is opened during venting of the inlet or test sample.

## Partial flow method

In the partial flow mode the test sample is additionally evacuated by an auxiliary pump. Using the optional partial flow pump set offers to the user the following advantages (ELD500 and ELD500 FLEX:

- faster response time
- entry into the measure mode already at an inlet pressure of 1000 mbar
- faster venting of large test objects

Alternatively to a partial flow pump set an external auxiliary pump may also be connected via a tee, this option is possible for the ELD500 dry and ELD500 FLEX also. However, in such a case the ELD500 will not be able to make measurements already at an inlet pressure of 1000 mbar.

## Sniffer mode

The ELD500 may simply be converted into a sniffer leak detector via the rugged sniffer line (Cat. No. 252003).

For this the KF flange of the sniffer line is connected to the inlet flange (Figure 1 item 1) and the sniffer mode is selected through menu mode. After pressing START, the inlet valve V1 (Figure 2) opens. The sniffer lines have been designed in such a way that the ELD500 is operated in the FINE mode. If the fore vacuum pressure P2 increases over 0.2 mbar respectively 0.1 mbar a warning sign and audio alarm comes up in the display.

In the measurement mode the helium present in the ambient air is now indicated as the leak rate (about  $2 \times 10^{-6}$  mbar l/s). Smaller leaks may be detected by pressing the ZERO-button. In sniffer mode the smallest detectable leak rate is  $< 1 \times 10^{-7}$  mbar l/s.

## Supplied equipment

The ELD500 will be shipped in a special cardboard packed separately in a plastic foil as protection against dust.

Supplied equipment includes:

- Leak Detector ELD500
- Set of fuses
- Power cord
- Folder with documents (Operating instructions, Spare part list)
- 2 L-type screwed connections (hose connections)
- 1 hose nozzle
- Blank flange DN 25 KF
- Clamping ring DN 25 KF
- Centering ring DN 25 KF

## Technical data

### Technical data ELD500 WET

Physical data

**Table 1 ELD500 WET physical data**

Maximum inlet pressure	15 mbar
Minimum detectable Helium leak rates	
- in vacuum mode	$< 5 \times 10^{-12}$ mbar l/s

- in sniffer mode	<1 x 10 <sup>-7</sup> mbar l/s
Minimum detectable Hydrogen leak rates	
- in vacuum mode	<1 x 10 <sup>-8</sup> mbar l/s
- in sniffer mode	<1 x 10 <sup>-7</sup> mbar l/s
Maximum Helium leak rate which can be displayed	0.1 mbar l/s
Measurement range	12 decades
Time constant of the leak rate signal (blanked off, 63% of the final value)	<1 s
Pumping speed (Helium) at the inlet	
- GROSS mode	0.4 l/s
- FINE mode	> 2.5 l/s
Detectable masses	2, 3 and 4
Mass spectrometer	180° magnetic sector field
Ion source	2 filaments; Iridium/Yttrium-oxide
Inlet port	DN 25 KF
Run-up time (after starting)	< 2 min

To get down to the minimum detected leak rate range some conditions must be fulfilled:

- ELD500 WET has to run at least 20 minutes.
- Ambient conditions must be stable (temperature, no vibration/accelerations).
- The part under test has been evacuated long enough without using the zero function (background is no longer decreasing).
- ZERO must be active.

#### Electrical data

**Table 2 ELD500 WET electrical data**

Power supply	230 V a.c., +/- 5%, 50/60 Hz
	115 V a.c., +/- 5%, 60 Hz
	100 V a.c., +/- 5%, 50/60 Hz
Power consumption	420 VA
Type of protection	IP40

#### Other data

**Table 3 ELD500 WET other data**

Valves	Solenoid
Dimensions (L x W x H) (mm)	495 x 456 x 314
Weight (kg)	40.0
Noise level (dB (A))	< 54

**Table 3 ELD500 WET other data (continued)**

Maximum audio alarm (dB (A))	90
Contamination level (to IEC 60664-1)	2
Over-voltage category (to IEC 60664-1)	II

## Environmental conditions

**Table 4 ELD500 WET environmental conditions**

For use within buildings	
Permissible ambient temperature (during operation)	+10 °C to +40 °C
Permissible storage temperature	-10 °C to +60 °C
Maximum relative humidity	80% (up to 31 °C) linear decreasing to 50% at 40 °C
Maximum permissible height above sea level (during operation)	2000 m

**Technical data ELD500 DRY**

## Physical data

**Table 5 ELD500 DRY physical data**

Maximum inlet pressure	15 mbar
Minimum detectable Helium leak rates	
- in vacuum mode	$< 3 \times 10^{-11}$ mbar l/s
- in sniffer mode	$< 1 \times 10^{-7}$ mbar l/s
Minimum detectable Hydrogen leak rates	
- in vacuum mode	$< 1 \times 10^{-8}$ mbar l/s
- in sniffer mode	$< 1 \times 10^{-7}$ mbar l/s
Maximum Helium leak rate which can be displayed	0.1 mbar l/s
Measurement range	11 decades
Time constant of the leak rate signal (blanked off, 63% of the final value)	<1 s
Pumping speed (Helium) at the inlet	
GROSS mode	0.02 l/s
PRECISION mode	0.4 l/s
FINE mode	> 2.5 l/s
Detectable masses	2, 3 and 4
Mass spectrometer	180° magnetic sector field
Ion source	2 filaments; Iridium/Yttrium-oxide
Inlet port	DN 25 KF

**Table 5 ELD500 DRY physical data (continued)**

Run-up time (after starting)	< 2 min
------------------------------	---------

To get down to the minimum detected leak rate range some conditions must be fulfilled:

- ELD500 has to run at least 20 minutes
- Ambient conditions must be stable (temperature, no vibration/accelerations.)
- The part under test has been evacuated long enough without using the zero function (background is no longer decreasing)
- ZERO must be active

#### Electrical data

**Table 6 ELD500 DRY electrical data**

Power supply	230 V a.c., 50 Hz
	115 V a.c., 60 Hz
	100 V a.c., 50/60 Hz
Power consumption	350 VA
Type of protection	IP40

#### Other data

**Table 7 ELD500 DRY other data**

Valves	Solenoid
Dimensions (L × W × H) (mm)	495 x 456 x 314
Weight (kg)	35.5
Noise level (dB (A))	< 54
Maximum audio alarm (dB (A))	90
Contamination level (to IEC 60664-1)	2
Over-voltage category (to IEC 60664-1)	II

#### Ambient conditions

**Table 8 ELD500 DRY ambient conditions**

For use within buildings	
Permissible ambient temperature (during operation)	+10 °C to +40 °C
Permissible storage temperature	-10 °C to +60 °C
Maximum relative humidity	80% (up to 31 °C) linear decreasing to 50% at 40 °C

**Table 8 ELD500 DRY ambient conditions**

Maximum permissible height above sea level (during operation)	2000 m
--	--------



## Technical data ELD500 FLEX

### Physical data

**Table 9 ELD500 FLEX physical data**

Maximum inlet pressure	15 mbar
Minimum detectable Helium leak rates	
in vacuum mode	
- with Scroll pump	$< 8 \times 10^{-12}$ mbar l/s
- with oil sealed pump	$< 5 \times 10^{-12}$ mbar l/s
in sniffer mode	$< 1 \times 10^{-7}$ mbar l/s
Minimum detectable Hydrogen leak rates	
- in vacuum mode	$< 1 \times 10^{-8}$ mbar l/s
- in sniffer mode	$< 1 \times 10^{-7}$ mbar l/s
Maximum Helium leak rate which can be displayed	0.1 mbar l/s
Measurement range	12 decades
Time constant of the leak rate signal (blanked off, 63% of the final value)	$< 1$ s
Pumping speed (Helium) at the inlet	
GROSS mode	1.0 l/s
FINE mode	$> 2.5$ l/s
Detectable masses	2, 3 and 4
Mass spectrometer	180° magnetic sector field
Ion source	2 filaments; Iridium/Yttrium-oxide
Inlet port	DN 25 KF
Run-up time (after starting)	$< 2$ minutes

To get down to the minimum detected leak rate range some conditions must be fulfilled:

- ELD500 has to run at least 20 minutes
- Ambient conditions must be stable (temperature, no vibration/accelerations.)
- The part under test has been evacuated long enough without using the zero function (background is no longer decreasing)
- ZERO must be active

### Electrical data

**Table 10 ELD500 FLEX electrical data**

Power supply	100 - 240 V a.c., 50/60 Hz
Power consumption	200 VA
Type of protection	IP40
Power cords (EU, USA, UK)	2.5 m

## Other data

**Table 11 ELD500 FLEX other data**

Valves	Solenoid
Dimensions (L x W x H) (mm)	495 x 456 x 314
Weight (kg)	35.5
Noise level (dB (A))	< 54
Maximum audio alarm (dB (A))	90
Contamination level (to IEC 60664-1)	2
Over-voltage category (to IEC 60664-1)	II

## Environmental conditions

**Table 12 ELD500 FLEX environmental conditions**

For use within buildings	
Permissible ambient temperature (during operation)	+10 °C to +40 °C
Permissible storage temperature	-10 °C to +60 °C
Maximum relative humidity	80% (up to 31°C) linear decreasing to 50% at 40 °C
Maximum permissible height above sea level (during operation)	2000 m

**Dimensional drawings**

Figure 5 Dimensions ELD500

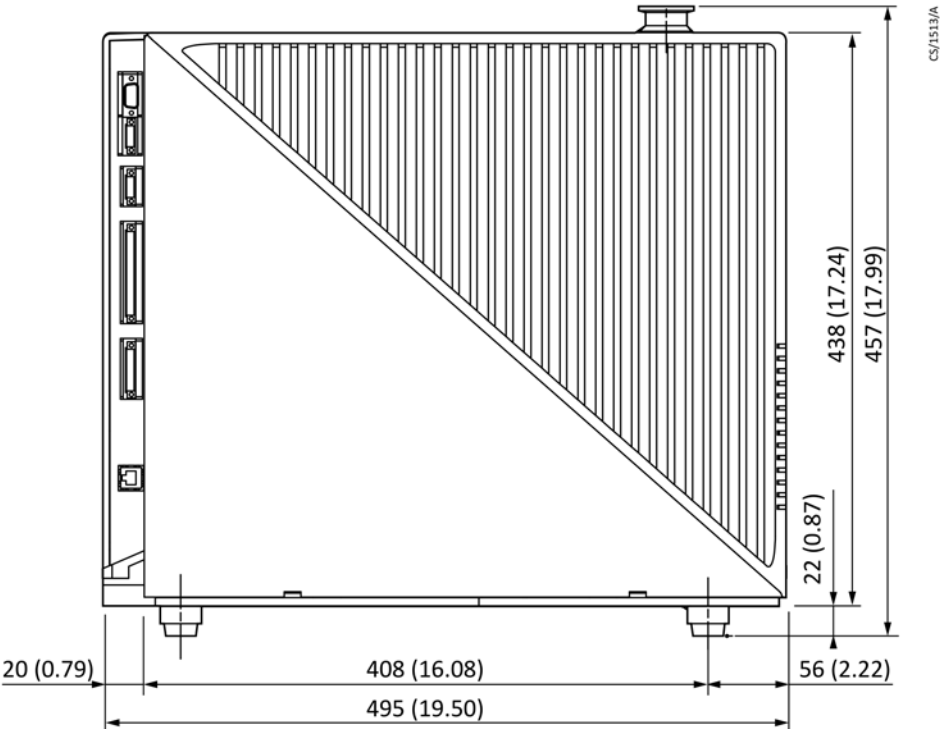
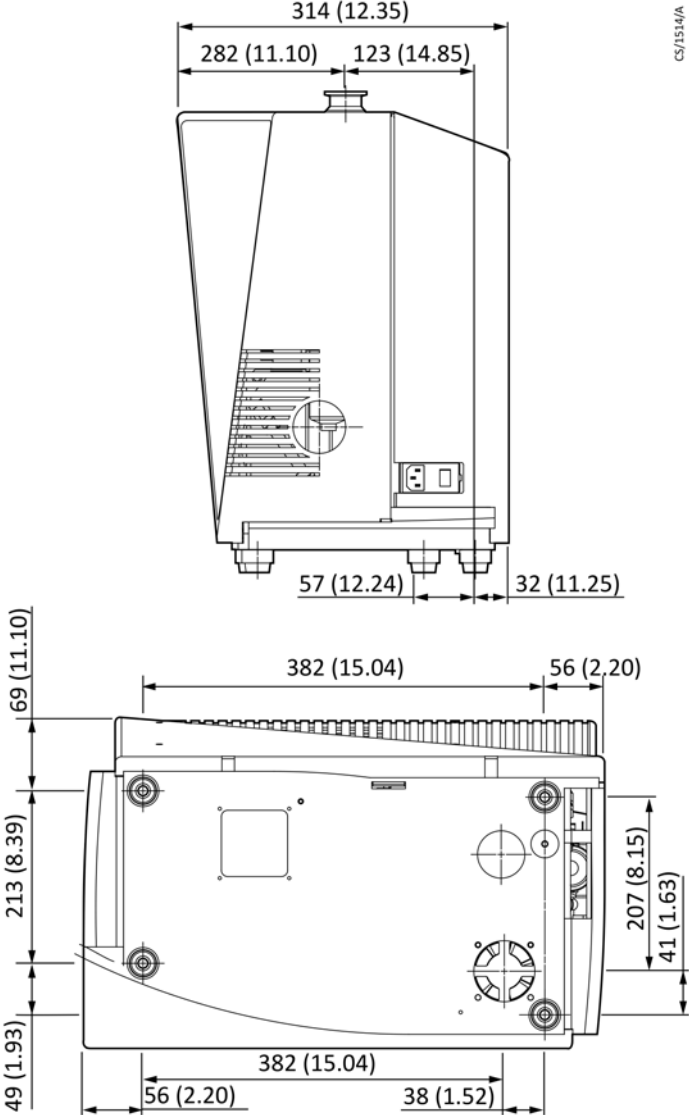
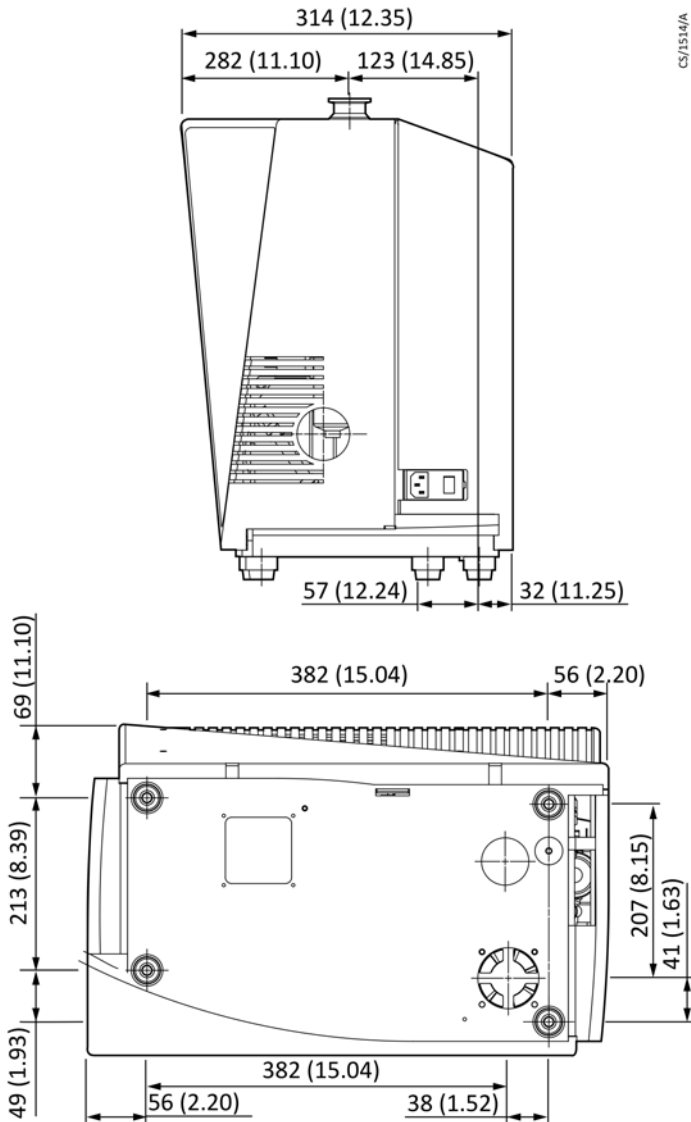

Figure 6 Dimensions ELD500 side view



**Figure 7 Dimensions ELD500 FLEX**



## Ordering information

ELD500 WET, 220 to 240V, 50/60Hz	D13510903
ELD500 DRY, 220 to 240V, 50/60Hz	D13520903
ELD500 WET, 100 to 120V, 50/60Hz	D13510904
ELD500 DRY, 100 to 120V, 50/60Hz	D13520904
ELD500 FLEX	D13530000
ELD500 WET, 105V, 60Hz	D13510906
ELD500 DRY, 105V, 60Hz	D13520906

## Accessories

The following parts can be ordered additionally:

ELD 500 RC-wired	D135 50 100
ELD 500 RC-wireless	D135 50 110
ELD 500 RC -wired 8m extension cable	14022
ELD500 RC-wireless additional transmitter	D135 50 130
ELD 500 SL	D135 50 300
ELD 500 SL - extender interface	D135 50 200
ELD 500 SL - extended 5 m	14008
ELD 500 SL - extended 20 m	14009
ELD 500 SL - extended 50 m	12183
ELD 500 partial flow adaptor	D135 50 400
ELD 500 transport case	D135 50 500
ELD 500 cart	D135 50 600
ELD 500 cart - 230 V	D135 50 610
ELD 500 cart - 115 V	D135 50 620
ELD 500 SG	D135 50 700
CL - internal	D135 50 910
CL - bespoke leak rate 0.5 to 1E-7mbar l/s - screwed socket	D135 50 930
CL - He 4 to 6	D135 50 950

### Sniffer line (ELD500 SL)

With the use of the ELD500 SL, the ELD500 can easily be converted to a sniffer leak detector.

Available versions:

- ELD 500 SL
- ELD 500 SL - extender interface
- ELD 500 SL - extended 5 m
- ELD 500 SL - extended 20 m
- ELD 500 SL - extended 50 m

For further information on the sniffer lines see the enclosed manuals.

## Remote control RC wired and RC wireless

Figure 8 Remote control RC wireless



For further information on the remote controls, RC wired and wireless, see instruction manual for the remote.

## Partial flow adaptor (ELD500)

In the partial flow mode the test sample is additionally evacuated by an auxiliary pump. Using the optional partial flow pump set offers to the user the following advantages:

- faster response time
- entry into the measurement mode already at an inlet pressure of 1000 mbar
- faster venting of large test objects

The partial flow adaptor consists of the components partial flow valve block, right angle valve DN 25 KF, control cable and vacuum hose with flange connections.

The partial flow valve block with the right angle valve has to be connected to the inlet flange of the ELD500. Connect the control cable to the Option port and the vacuum hose to the auxiliary pump. The ELD500 has to be configured as described in chapter.

For further detailed information, refer to operating instructions for the partial flow adaptor.

## Default settings

The following parameters are set like shown when in the menu of the ELD500 under Settings > Parameters, Load/Save is chosen.

Scale	linear
Display range:	4 decades
Time axis:	32 seconds
LCD inverted	off
Background in standby mode:	off
Calibration request:	Off

	Mass:	4 (helium)
	Recorder:	Leak rate
	Volume:	2
	Leak rate unit:	mbar l/s
	Mode:	Vacuum
	Trigger level 1:	1E-9 mbar l/s
	Trigger level 2:	1E-8 mbar l/s
	Trigger level 3:	1E-7 mbar l/s
	Leak rate external test leak (vacuum):	1E-7 mbar l/s
	Leak rate external test leak (sniffer):	1E-5 mbar l/s
	Vent delay:	2 seconds
	Automatic purge (ELD500 DRY and ELD500 FLEX only)	On
	Pressure:	mbar
	Minimum volume:	0
	Beep:	On
	Maximum evacuation time:	30 minutes
	Audio Alarm Type:	Trigger alarm
	Maximum pressure limit for sniff mode	0.15 mbar
	Minimum pressure limit for sniff mode	0.05 mbar
	Control location	Local
	Alarm delay:	30 seconds
	Leak rate filter:	Auto
	Zero:	Enable
1.	VENT Vacuum ranges	Normal
2.	EXHAUST Upper display limit	1E-5 mbar l/s
3.	GAS BALLAST Service message exhaust oil filter (ELD500 DRY)	On
4.	On/Off switch, mains socket	
5.	SERIAL Contamination protection	Off
6.	CONTROL-2 Switch-off limit for contamination protection:	1E-3 mbar l/s
7.	RECORD Limits: 1E-6 mbar l/s ... 1E+3 mbar l/s)	
8.	CONTROL	
9.	OPTION	
10.	REMOTE 1	
11.	REMOTE 2	



# Installation

## Placement



### **WARNING:**

**Product can be up to 40kg. Ensure 2 people are present for the unpacking and remove packaging needed to ensure a safe lift. On subsequent moves ensure it is done with 2 people.**

Unpack the ELD500 immediately after delivery, even if it will be installed later on.

Examine the shipping container for any external damage. Completely remove the packaging materials.

Check the ELD500 is complete (see Chapter Supplied Equipment) and carefully examine the ELD500 visually.

If any damage is discovered, report it immediately to the forwarding agent and insurer. If the damaged part has to be replaced, contact the orders department.

Retain the packaging materials in the case of complaints about damage.

## Conforming utilisation

The ELD500 is a leak detector for Helium or Hydrogen. This instrument may be used to detect the location and the size of leaks on objects under test in two different ways:

when the test sample has been evacuated first and is sprayed with helium on the outside. It is required that a vacuum connection is provided between the ELD500 and the test sample (vacuum mode).

or

when a helium overpressure is provided in the test sample and the test sample is searched from the outside with a sniffer probe which is attached to the inlet port (sniffer mode).

The ELD500 is to be used for leak detection only. It must not be used as a pumping system (especially pumping aggressive or humid gases.)

The leak detector is not suitable for

- pumping liquids or gases containing dust or particles
- pumping corrosive or reactive gases

## Ambient conditions

The permissible ambient temperature is between +10 °C (50 °F) and +40 °C (104 °F).

The ELD500 must not be operated in explosive gas atmospheres.

Make sure to avoid dripping water.

Ensure a sufficient air cooling.

## Electrical connections

### Mains power



**WARNING:**

Generally the local regulations for electrical connections must be observed.

Before connecting the ELD500 to the mains, ensure that the mains voltage rating of the ELD500 matches the locally available mains voltage. The instrument must exclusively be connected to a single phase supply with specified fuses fitted (circuit breaker 10 A maximum according to IEC/EN 60898 with tripping characteristic B).

Only 3-core mains cables having a protection ground conductor must be used. Operation of the ELD500 where the ground conductor has been left unconnected is not permissible. The ELD500 can be damaged when using the wrong voltage. The voltage must be in the range 230 V (+/- 5%) or 115 V (+/- 5%) depending on the version.

The mains voltage rating for the ELD500 can be read off from the name plate beneath the mains socket, [Figure 9](#) item 4, at the side. This voltage is fixed and can not be changed.

A separate fuse for each of the mains conductors has been integrated into the mains switch.

The mains voltage is applied to the instrument via the detachable mains cable which is supplied with the instrument. A mains socket, [Figure 9](#) item 4, is available for this purpose at the side of the instrument.

**Figure 9 Side views of the ELD500**

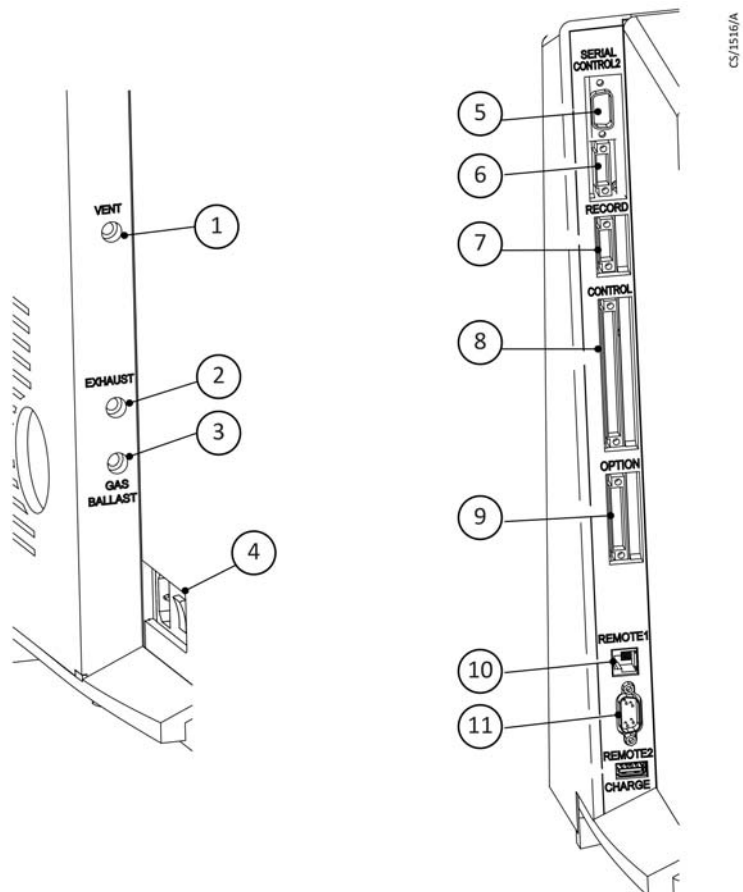

## Connection for the controller signal and accessories

### Option (accessories)

The ELD500 SL or the partial flow adaptor may be connected to the option port (Figure 9 item 9):

Contact pins 1 and 3 are fused together with a 0.8 A slow-blow fuse. The amount of power which can be drawn is limited to 10 W.

The contacts are numbered from bottom to top.

**Table 13 Option (accessories) connector pin-outs**

Pin	Assignment
1	+24 V, constantly applied, power supply for the partial flow valve or sniffer line.
2	GND
3,	+24 V switched by the ELD500 for an external venting valve
4, 5, 6, 7, 8	These pins are used in connection with accessories.

### Digital out (CONTROL)

The following relay outputs, Figure 9 item 8, are available for further signal processing. The maximum rating for the relay contacts is 60 V AC/1A.



#### **CAUTION:**

**All pins of digital I/O, digital out and recorder must not be connected with voltages higher than 60 V d.c./25 V a.c. (to grounding equipment conductor) or reach this threshold.**

The contacts are numbered from bottom to top.

**Table 14 Digital out (CONTROL) connector pin-outs**

Pin	Assignment
1	PLC in free selectable
2	PLC in free selectable
3	PLC in free selectable
4	GND
5 to 7	Digital out free selectable, 5 centre contact, 6 normally open contact, 7 normally closed contact
8 to 10	Digital out free selectable
11 to 13	Digital out free selectable
14 to 16	Digital out free selectable

The pin assignment for contacts 8 to 16 follows the same order as for pins 5 to 7.

For further information see chapter Interfaces.

### Digital in (Control 2)

These inputs can be used to control the ELD500 with a programmable logic controller (PLC).

The contacts are numbered from bottom to top.

**CAUTION:****Maximum input voltage 35 V.****Table 15 Digital in (Control 2) connector pin-outs**

Pin	Assignment
1	PLC in free selectable
2	PLC in free selectable
3	PLC in free selectable
4	PLC GND

These inputs, [Figure 9](#) item 6, are working only if the correct location of control is chosen. See chapter Interfaces.

To avoid a mistake between the connection Control 2 and Record, pin 1 and 4 are blocked. When using the connectors the guiding nose for pin 1 and 4 must be removed.

**Recorder/RECORD**

The recorder output [Figure 9](#) item 7 may be used to chart the leak rate, the inlet pressure and the fore vacuum pressure. Both recorder activities can be adjusted individually for showing leak rates and pressures.

The measured values are provided by way of an analogue signal in the range of 0 to 10 V. The resolution is limited to 10 mV. The instrument which is connected to the recorder output (for example, X(t) chart recorder) should have an input resistance of no less than 2.5 kW. The measured values are available through pins 1 and 4. The reference potential (GND) is available at pins 2 and 3.

The contacts are numbered from bottom to top.

The chart recorder outputs are electrically isolated from other plugs. If, in spite of this, hum interference is apparent it is recommended to operate the ELD500 and the chart recorder from the same mains phase. If this is not possible, ensure that the frame ground of both instruments is kept at the same potential.

**Table 16 Recorder/RECORD connector pin-outs**

Pin	Assignment
1	Analog 1, leak rate, inlet pressure P1 or fore vacuum pressure P2
2	GND
3	GND
4	Analog 2, leak rate, inlet pressure P1 or fore vacuum pressure P2

For further information see chapter Interfaces.

**SERIAL/RS232**

This RS232 interface, [Figure 9](#) item 5, is wired as data communication equipment (DCE) and permits the connection of a personal computer (PC) for monitoring and data logging. The connection is made through a 9 pin sub-D socket. For more information refer to chapter Interfaces and the Interface Description.

**Table 17 SERIAL/RS232 connector pin-outs**

Pin	Assignment
1	24 V switchable, default setting 0
2	TXD
3	RXD
4	GND 24V
5	GND
6	DSR
7	CTS
8	RTS
9	Free

**Remote control (REMOTE1)**

The remote control interface, [Figure 9](#) item 10, is a serial interface to control the ELD500 by the remote control. The remote control can be connected via an extension cable with a RJ45 plug. Refer to the Interface Description for more information. The remote control does not belong to the standard equipment. If the remote control is connected via a cable, wireless communication over REMOTE2 is excluded.

**Table 18 Remote control (REMOTE1) connector pin-outs**

Pin	Assignment
2	+24 V (fuse 0.8 A time lag)
3	0 V
4	RXD (internal RS232)
5	TXD (internal RS232)

**Remote control (REMOTE2)**

Through this interface the ELD500 is controlled wirelessly via Bluetooth or WLAN. The Bluetooth transmitter connects to the remote control ELD500 RC-Wireless. The WLAN module provides the connection to handheld devices. Is the remote control ELD500 RC-Wireless connected via a cable to REMOTE1 REMOTE2 can not be used. The Bluetooth transmitter and the WLAN module are not included ELD500 delivery.

**Table 19 Remote control (REMOTE2) connector pin-outs**

Pin	Assignment
1	Free
2	RxD
3	TxD
4	Connected to pins 6 and 7
5	GND
6	Connected to pins 4 and 7
7	Connected to pins 4 and 6
8	Free

**Table 19 Remote control (REMOTE2) connector pin-outs**

Pin	Assignment
9	7.5 V

## CHARGE

The USB interface is for charging remote controls only. The USB port does not allow data exchange.

## Vacuum connections

### Inlet port

The inlet port is located on the top of the ELD500, [Figure 1](#) item 1. The size of the flange is DN 25 KF.

A test object or a test chamber has to be connected to the inlet port if the vacuum mode is chosen (refer to [Mode](#)).

The inlet port is also used for the connection of the sniffer line.

### Exhaust

The exhaust [Figure 9](#) item 2 flange is located on the side of the ELD500.

There is a filter mounted in the exhaust that absorbs the oil steams occurring during the use of the rotary vane pump. The exhaust filter has to be cleaned when doing the maintenance (see [Exhaust oil filter](#)).



### **WARNING:**

**When the ELD500 is running in closed rooms the exhaust has to be put out-of-doors using the provided adapter. So the oil steams that are harmful to health are lead off.**

With the provided connection a hose line can be connected to the exhaust of the ELD500 and lead off.

### Vent

Usually the parts under test are vented with ambient air when the test is finished. If it is required the parts can be vented with a different gas (that is, fresh air, dry air, nitrogen, and so forth) at atmospheric pressure. In this case a vent hose has to be connected to the hose coupling [Figure 9](#) item 1. The pressure in the venting line must not exceed 1050 mbar.

### Gas ballast connection

For the mode gas ballast it is recommended to use helium-free gases at atmospheric pressure. Ambient air can be contaminated with helium due to spraying or charging. In this case a gas supply line (that is, nitrogen, fresh air, and so forth) should be connected to the hose coupling, [Figure 9](#) item 3. The pressure of these gas line must not exceed 1050 mbar.

The connectors 1,2 and 3 in [Figure 9](#) are quick connectors for hose diameters of 8/6 mm.

### Connection of an external pump (only ELD500 FLEX)

The ELD500 FLEX offers two possibilities to connect the external fore vacuum pump to the DN 25 KF flange. One on the side of the ELD500 or one in the bottom (measurements see [Figures 5, 6 and 7](#)). As default setting the flange on the side is chosen. To change the connection proceed as follows:

1. Take of the mechanical hood, see chapter Opening of the ELD500.
2. Loose the flange with the connection piece on the side of the ELD500.
3. Disconnect the blind flange on the bottom, therefore lay the ELD500 carefully on the electronic hood.
4. Screw in the connection piece into the flange in the bottom.
5. Connect the hose for the fore vacuum pump.
6. Connect the blind flange to the sidewise flange.
7. Put on the mechanical hood.





# Operation

## Media compatibility/purge gas

The ELD500 is a leak detector for helium and hydrogen. Only air and clean gases must be used with the ELD500.

The leak detector is not suitable for

- pumping liquids or gases containing dust
- pumping reactive or corrosive gases

As purge gas all gases can be used that

- does not contain helium
- are dry, clean and dust free
- generate no corrosion.

For venting or gas ballast a helium free gas at atmospheric pressure should be used. Ambient air can be contaminated with helium due to spraying or charging, so it is recommended to connect a hose to the vent- and fore vacuum port. The pressure in this hose must not exceed 1050 mbar.

## Start-up

The ELD500 is switched on by pushing the mains switch (refer to [Mains power](#)). After about 2 minutes the run-up procedure is finished; the unit is in standby-mode and ready to measure.

When using the ELD500 FLEX an additional fore vacuum pump (dry or wet version) has to be connected to the fore vacuum connection (DN25 KF) on the side or the bottom.

Connect the part to be tested to the inlet port and press START. The ELD500 starts to evacuate the part. The evacuation time depends on the volume of the test part. During evacuation the screen shows the inlet pressure online.

Once the pressure of 15 mbar (11 Torr or 1500 Pa) is reached the unit switches to measurement mode. The corresponding leak rate is displayed. For further explanations of the screen refer to [The display in measurement mode](#).

The displayed leak rate corresponds to the helium background concentration in the part under test. Since the ELD500 continues to pump down the part this background leak rate will further reduce. As soon as the leak rate is low enough in respect to the requirements, spraying helium or hydrogen to search for possible leaks can be started.

When the measurement is finished press STOP and hold the button a few seconds to vent the part under test.

## Display

The display is used to either show leak rates or program specific set-ups and get information by means of the software menu (refer to [Main menu](#)). In addition messages and maintenance instructions are displayed on the screen (refer to [Maintenance](#)).

## The Display in run-up mode

In run-up mode the display shows:

- Speed of the turbomolecular pump
- Fore-vacuum pressure
- State of emission
- Active filament
- A bar graph which shows the run-up progress

Change the contrast if the display is too bright or dark (see [Control panel](#)). During run-up phase the menu button can be pushed to get to the selection menu.

## The display in standby mode

In standby mode the conditions are shown in the upper edge of the display ([Figure 12](#)). Furthermore calibration (refer to [Calibration](#)) can also be started in standby mode and purging, too ([Figure 1](#) item 1)

## Gas ballast/purge

In standby mode the gas ballast of the fore-pump can be switched on/off manually or via Softkey 7. The gas ballast is for abolishing a too huge helium background. Additionally a condensation of water vapour in the pump will be avoided. After 20 minutes the machine closes the gas ballast valve automatically to limit the loss of oil.

This function can be chosen automatically for the ELD500 FLEX. Every time the unit changes into standby mode the purge starts automatically for 20 seconds. During this time the scroll pump will be purged by the valve V6.

In case there was a large quantum of water vapour pumped with the machine, activate the gas ballast for about 20 minutes before running the machine down.

## The display in measurement mode

In measurement mode the leak rates can be displayed in two different modes:

- Numerically, combined with a bar graph 10 refer to [Figure 10](#).
- As trend: numerically, combined with a diagram (leak rate versus time) [Figure 11](#).

The lower right corner of the display (next to the Softkey no. 8, [Figures 10](#) and [11](#)) displays a symbol that allows to switch between the display modes by pressing Softkey no. 8. See [Measurement mode with bar graph](#) and [Measurement mode with trend information](#) for explanations of the different display modes.

Access to calibration (Softkey no. 5, [Figures 10](#) and [11](#)) and access to the speaker volume (Softkeys no. 2 and no. 3, [Figures 10](#) and [11](#)) is the same in all modes. Also the status icons in the upper line are in common in both display modes.

**Figure 10 Display: measurement mode with bar graph**

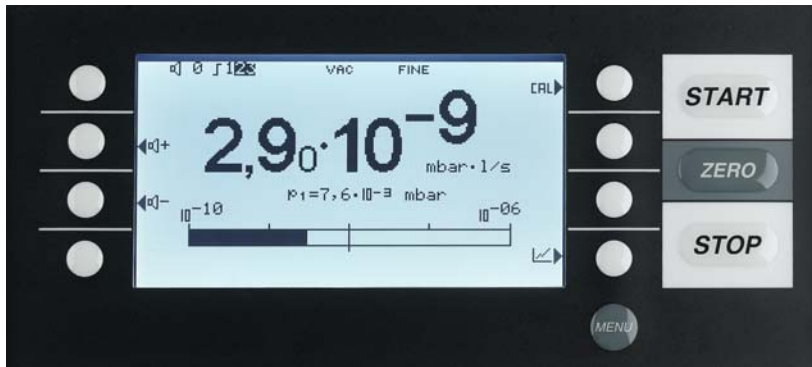

**Call for calibration**

In all modes the Softkey no.5 is used to get to the calibration routine. Refer to [Calibration](#) for further information regarding calibration.

**Speaker volume**

On the left hand side two loud speaker symbols are shown, combined with the signs + and - (Figures 10 and 11). By pressing the corresponding Softkeys (Softkeys no. 2 and no. 3) the volume can be adjusted for convenient loudness. In the bottom line of the display another loud speaker symbol is shown, combined with a number. This number indicates the level of the current loudness (ranges from 0 to 15).

Refer to [Volume](#) for information on loudness, alarms, and sound tracks.

**Status line in the display**

The status line at the top of the display (Figures 10 and 11) informs about (reading from left to right):

**Table 20 Status line symbol meanings**

Symbol of display	Meaning	Description
	Volume level	Refer to <a href="#">Volume</a> .
S1	Trigger 1	If the trigger values are exceeded these signs are inverted. (White on black background.)
S2	Trigger 2	see: Trigger 1
S3	Trigger 3	see: Trigger 1
!	Warning triangle	Refer to <a href="#">Maintenance</a> .
VAC	Working mode	VAC or SNIFF indicate which working mode was selected.
FINE	Vacuum area	Depending on the inlet pressure the ELD500 may be in GROSS, PRECISION (ELD500 DRY only) or FINE mode, which is indicated here ( <a href="#">Vacuum settings</a> ).

**Table 20** Status line symbol meanings

Symbol of display	Meaning	Description
ZERO	ZERO	Indicates if ZERO-function is active.

## Measurement mode with bar graph

The display shows the leak rate in big digital figures, see [Figure 10](#). The unit of the leak rate is shown, too. Underneath the leak rate the inlet pressure is displayed in smaller digits. The units of leak rate and pressure can be defined in the menu (see [Units](#)).

Below this the same leak rate is shown graphically as a bar. The scale of this bar, that is, the number of decades included in this bar can be defined in the menu (see [Display-range auto/manual](#)). The programmed trigger levels (see [Trigger level 1](#) and [Trigger level 2](#)) are indicated at the bar by short vertical lines: a straight line for trigger 1 and a dotted line for trigger 2.

## Measurement mode with trend information

In trend mode the leak rates are displayed over time [Figure 11](#). In addition the actual leak rate and inlet pressure also are displayed digitally. The time axis can be defined in the menu (refer to [Time axis](#)). The intensity axis (y-axis) is defined the same way as the bar graph (refer to [Display-range auto/manual](#)).

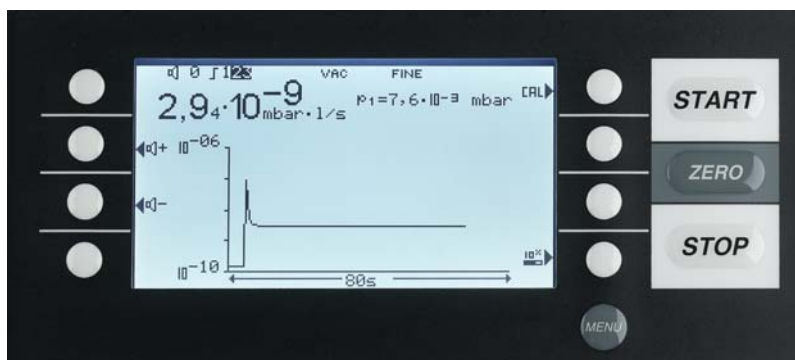
**Figure 11** Display: measurement mode with bar graph

## First operation check

The steps for an initial operation are described here. It is explained how to switch on the ELD500, how to measure and how to carry out an internal calibration.

If anything unexpected happens during the initial operation or the leak detector acts in a strange way the ELD500 can be switched off by the mains switch at any time.

## Needed equipment

The following parts will be needed:

- A blind flange 25 KF (if not assembled at the inlet port).
- A helium test leak with a DN 25 KF connection (optional).
- A fore vacuum pump connected to the DN25 KF flange on the side or under the bottom (dry or wet version) for use with the ELD500 FLEX

## Start-up and measure

1. Unpack the ELD500 and inspect it for any external damage (refer to [Placement](#)).
2. Connect the instrument to the mains power (refer to [Electrical connections](#)). For the ELD500 FLEX connect the fore vacuum pump and switch it on.
3. Switch on the ELD500 by using the mains switch.



### CAUTION:

**Don't switch the ELD500 on when ambient temperature is below 10 °C or above 40 °C.**

After power on a welcoming picture appears on the screen of the control panel [Figure 12](#), the status information on the speed of the turbo pump, the fore vacuum pressure, the emission and the active filament are given.

The start up procedure takes less than 2 minutes and the end is indicated by a signal. The ELD500 is in standby mode now ([Figure 12](#)).

4. Check if the inlet port ([Figure 1](#) item 1) is blanked off. If not, mount a blind flange with o-ring on the inlet port.
5. Press the START button. The inlet will be evacuated and if the inlet pressure drops below 15 mbar a measured leak rate will be displayed.
6. Press the STOP button, the ELD500 will go to standby. If STOP is pressed a few seconds the inlet of the ELD500 will be vented.
7. To finish the start-up procedure, proceed with step 21. For calibration proceed with step 8.

### Internal calibration

8. Proceed with the internal calibration (refer to [Internal calibration](#)). For better quantitative measurements, let the unit warm up (15 to 20 minutes).

Press Calibration (Softkey no. 5 [Figure 12](#) item 5) to get into the calibration menu.

Select internal (Softkey no. 4, [Figure 12](#) item 4) to choose the internal calibration.

The internal calibration starts automatically and takes about 30 seconds. After a successful calibration a visual and audible signal comes up.

9. Press the STOP button [Figure 12](#) item 12 until the message STANDBY/VENTED appears on the display. The inlet is vented now.

### Verification with an external test leak

To verify the accuracy, proceed through the following steps. A test leak is required. If a test leak is not available, continue with step 21.

10. Remove the blind flange from the inlet port and connect the open helium test leak to the inlet port.
11. Press the START button [Figure 12](#) item 10. The inlet will be evacuated and the leak rate of the test leak will be measured and displayed.

12. Press the STOP button [Figure 12](#) item 12 to stop the measurement. The ELD500 goes into standby mode.
13. Press the STOP button [Figure 12](#) item 12 again until the message STANDBY/VENTED appears on the display. The inlet is vented now.
14. Remove the helium test leak from the inlet port and put a blind flange onto the inlet port again.

### Measure with a test object

15. Remove the blind flange from the inlet port and connect the test object to the inlet port
16. Press the START button [Figure 12](#) item 10. The test object will be evacuated.
17. Start spraying Helium onto the outside of the test object. The leak rate of the test object will be shown in the display.
18. Press the STOP button [Figure 12](#) item 12 to stop the measurement. The ELD500 goes into standby mode.
19. Press the STOP button [Figure 12](#) item 12 again until the message STANDBY/Vented appears on the display. The inlet is vented now.
20. Remove the test object and put on a blind flange on the inlet port.

### Switch off

21. Switch off the ELD500 if the unit is in STANDBY or VENTED mode by using the mains switch [Figure 9](#) item 4.

## Control panel

The Control panel [Figure 12](#) contains a liquid crystal display (LC Display), the START, STOP, ZERO and MENU buttons and eight Softkeys for the different menus and inputs selections.

**Figure 12** Control panel

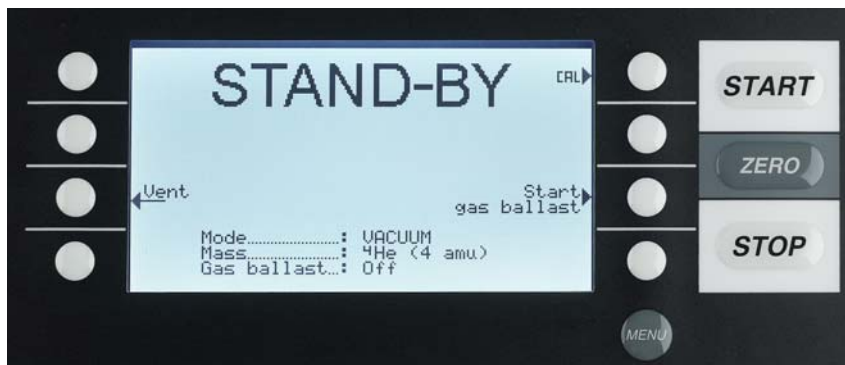

- |                  |                  |
|------------------|------------------|
| 1. Softkey no. 1 | 8. Softkey no. 8 |
| 2. Softkey no. 2 | 9. LC Display    |
| 3. Softkey no. 3 | 10. START        |
| 4. Softkey no. 4 | 11. ZERO         |

- 5. Softkey no. 5
- 6. Softkey no. 6
- 7. Softkey no. 7
- 12. STOP
- 13. MENU

<p>LC Display</p>	<p>The LC Display, <a href="#">Figure 12</a> item 9, is the communication interface to the operator. It displays the leak rates, the status report of the ELD500, messages, warnings and errors. With the Softkeys no.1 to no. 8 various functions which are shown in the display can be selected.</p>
<p>START button</p>	<p>Pushing the START Button, <a href="#">Figure 12</a> item 10, enables the ELD500 to start the measure procedure. The measured leak rate is shown in the display. If the START button is pushed again in measurement mode, the maximum leak rate indicator ((hold) function) is activated. This indicator shows the maximum leak rate since START. By pressing the START-button again the (hold) function will be started again.</p>
<p>STOP button</p>	<p>Pushing the STOP Button, <a href="#">Figure 12</a> item 12, interrupts the measure procedure. If the button is pressed longer the inlet is vented according to the conditions defined in the menu Vent delay. See <a href="#">Vacuum settings</a> to select the time parameters of the venting.</p>
<p>ZERO button</p>	<p>Pushing the ZERO button <a href="#">Figure 12</a> item 11 enables the zero mode (see <a href="#">Filter and background</a>).</p> <p>When pressing ZERO the currently measured leak rate is taken as a background signal and is subtracted from all further measurements. As a result the displayed leak rate then is</p> <p><math>1 \times 10^{-8}</math> mbar l/s in GROSS  <math>1 \times 10^{-12}</math> mbar l/s in FINE</p> <p>After pressing ZERO (<a href="#">Figure 13</a>, t=1) the decreasing background is fitted to the course (<a href="#">Figure 13</a>, t=2) automatically. When the measurement signal declines below the saved background the underground value will automatically be equated with the measurement signal. As soon as the measurement signal is increasing again the saved decreasing value remains constant. Increasing of the signal are displayed clearly as a leak So it is possible to recognize leaks even when the signal is decreasing rapidly.</p>

Figure 13 Zero activation

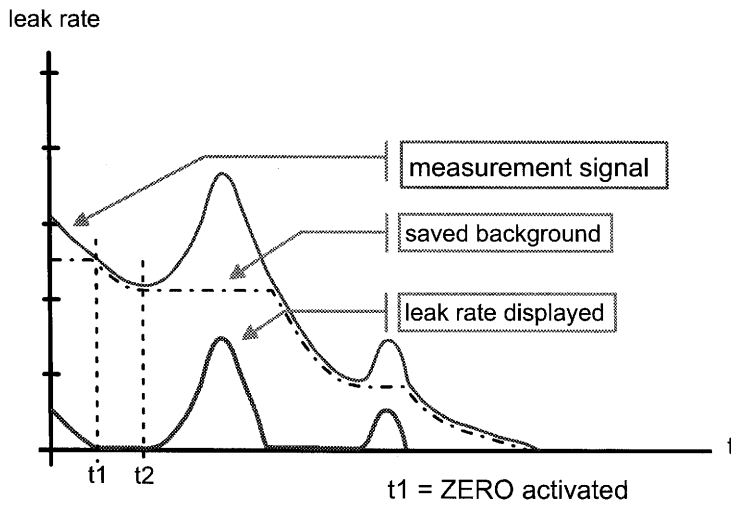
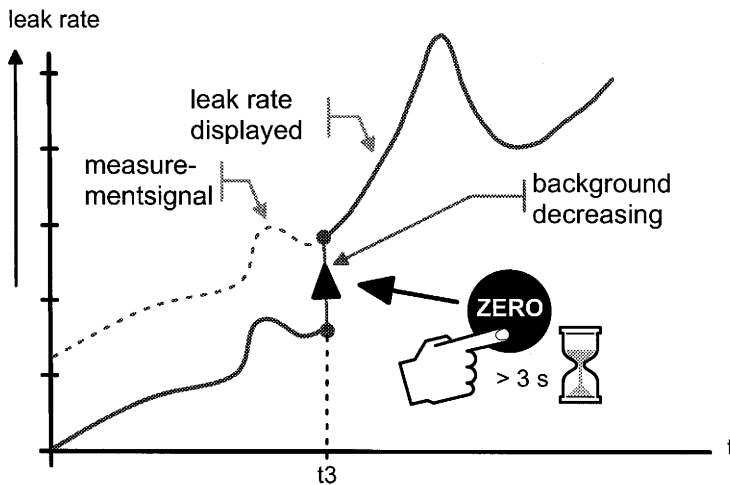

Figure 14 Undo zero



<p>MENU button</p>	<p>To see the measurement signal (including underground), press the ZERO button again. The saved value will be reset to zero. The underground signal will not be suppressed anymore (Figure 14).</p> <p>When pressing the MENU button (Figure 12 item 13) the selecting menu is shown at the display. This function is not depending on the operating mode when calibrating.</p> <p>If the menu is opened during the current session the operator will lead to the last screen before the menu was left.</p> <p>Pushing the MENU button again leads back to the screen of the previous working mode. The software shows the last screen that was used before.</p>
--------------------	---

Softkeys

The function of the eight Softkeys Figure 12 item 1 through 8 depends on the current menu.



## Special functions

When inputs are allowed or when settings can be selected in a sub-menu two of the Softkeys always have the same function:

Softkey no. 1 [Figure 12](#) item 1 is Cancel.

It allows to escape from the sub-menu without any changes of the present settings and return to the previous menu page.

Softkey no. 8 [Figure 12](#) item 8 is OK.

The selected settings or edited values will be stored and the previous menu page will be displayed again.

## Numerical entries

If a menu page has been opened where a digit can be changed, proceed in the following way:

If no change, press Softkey no. 1 Cancel.

To change the digit, proceed as follows:

1. The digit that can be changed is displayed inverted. With the arrows (Softkey no. 8) and (Softkey no. 4) digit that needs to change can be selected.
2. To change a digit to a specific number press the corresponding pair of numbers. A sub menu opens and the desired number can be selected. The sub menu closes automatically and the next digit of the total number now is inverted.
3. Having reached the last digit all changes have to be confirmed by OK (Softkey no. 8). To correct a wrong entry press Cancel (Softkey 1) or Softkey 4 and enter the desired value again.

### Example

To change the trigger level  $1.0 \times 10^{-7}$  mbar l/s to  $3 \times 10^{-7}$  mbar l/s, press 2/3 (Softkey no. 3, [Figure 16](#)). Consider that the first digit is displayed inverted. If not, change the digit with (Softkey no. 8) or (Softkey no. 4). With the Softkey no. 4 ([Figure 12](#)) the chosen value can be selected.

**Figure 15 Numerical entry of the trigger level, sample of the digit**

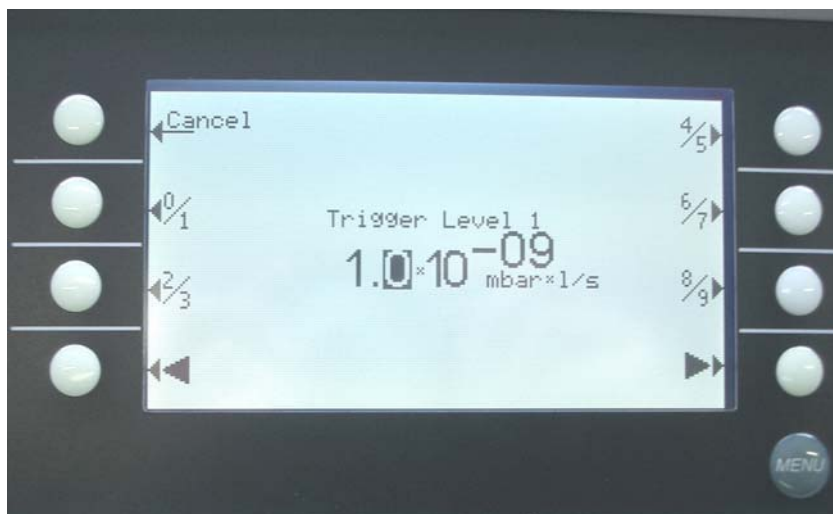

In the sub-menu press 3 (Softkey no.4) [Figure 16](#).

Figure 16 Trigger level, change of the first digit

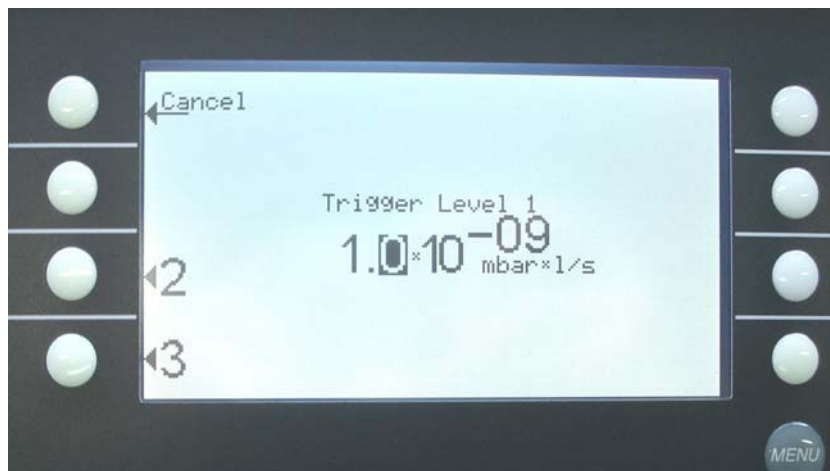

## Interfaces

Under Main menu > Settings > Interfaces the parameters for the interface can be set.

Softkey 2:            Location of control

The location of control for the leak detector can be defined

Softkey 3:            Define recorder output

Customer defined selection for the recorder output

Softkey 4:            RS232

Selection for the RS232

Softkey 5:            Define PLC outputs (Control, digital out)

Customer defined selection for PLC outputs

Softkey 6:            Define PLC inputs (Control 2, Digital in)

Customer defined selection for PLC inputs

Softkey 7:            Scaling recorder outputs

Selection for the scaling of the recorder output

Softkey 8:            PLC sample rate

Selection of the PLC sample rate

## Location of control

Main menu > Settings > Interfaces > Location of control

Softkey 2:            PLC

The ELD500 is controlled via the Digital In connector. The START, STOP and ZERO buttons at the control panel and remote control are locked.

Softkey 3:            RS232

The ELD500 is controlled via RS232 interface by an external computer. In this mode the ELD500 can not be controlled via keyboard. The START, STOP and ZERO button at the machine are deactivated.

Softkey 4:            All

The ELD500 is controlled via all possible controls, for example PLC, RS232, Local.

Softkey 5:            Local & PLC

The ELD500 is controlled via the Digital In connector or/and the START, STOP and ZERO buttons at the control panel and remote control.

Softkey 6: Local & RS232

The ELD500 is controlled via the Digital In connector or/and the START, STOP and ZERO buttons at the control panel and remote control.

Softkey 7: Local

The ELD500 is controlled via the START, STOP and ZERO buttons at the control panel or remote control. This is the default setting.

### Define recorder output

Main menu > Settings > Interfaces > Define recorder output

The signals to be recorded can be selected in this sub-menu. With the left keys the pin can be selected, with the right keys a function is assigned to the selected pin. The recorder output has 2 channels (Figure 18)

**Figure 17 Recorder output: Pirani ELD500, P1 and P2**

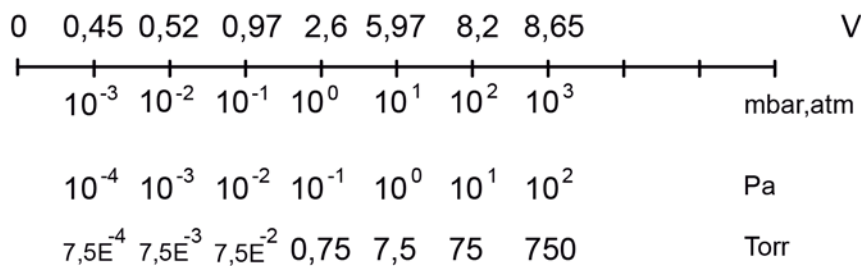

The complete characteristic Pirani line is shown in the appendix.

The following functions can be selected:

Off	The recorder output is switched off
P1 Pirani ELD500	The inlet pressure P1 of the ELD500 will be shown logarithmic (Figure 17).
P2 Pirani ELD500	The fore vacuum pressure P2 of the ELD500 will be shown logarithmic (Figure 17).
P1 (Legacy)	The setting for the inlet pressure P1 is from a legacy leak detector with the setting 1000 mbar comply 4 V with 0.5 V/decade logarithmic scale.
P2 (Legacy)	The setting for the fore vacuum pressure P2 is from a legacy Leak detector with the setting 1000 mbar comply 4 V with 0.5 V/decade logarithmic scale.
LR mantissa	The leak rate mantissa is recorded linearly from 1 to 10 V (Figure 20).

LR exponent	The exponent is recorded as step function: U = 1 to 10 V with steps of 0.5V per decade, starting with 1 V = $1 \times 10^{-12}$ mbar l/s (Figure 19).
LR linear	There will be two decades, the lower decade with voltages from 0.1 to 1.0V, the upper from 1.0 to 10.0 V output. The scale is linear. The (Zoom recorder output (leak rate) upper limit (= 10 V)) specified exponent determines the upper decade.
LR log	The fundamental output voltage is scaled logarithmic and can be freely chosen. The voltage output ranges from 1 to 10 V with adjustable steps of 0.5/1/2/2.5/5 to 10 V per decade (Figure 21 shows the default setting)

**Figure 18 Recorder output: P1 and P2 Legacy**

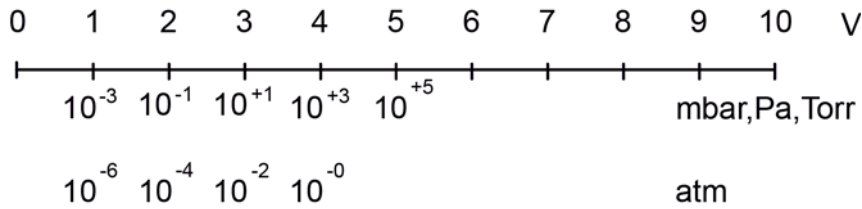

**Figure 19 Recorder output: Leak rate exponent**

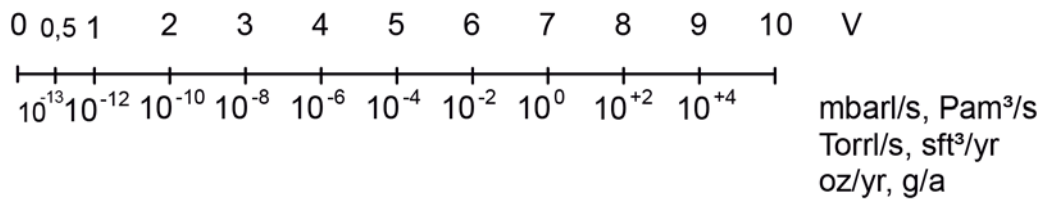

**Figure 20 Recorder output: Leak rate mantissa**

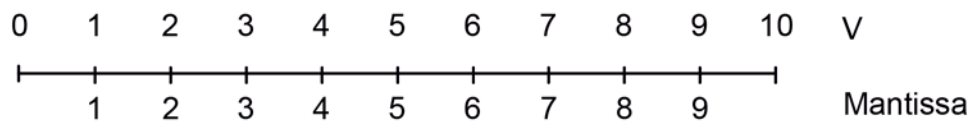

**Figure 21 Recorder output: Leak rate logarithmic, default setting**

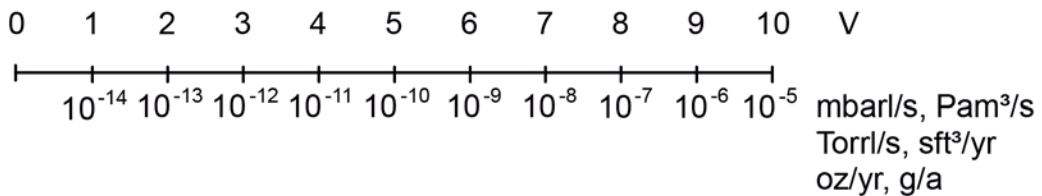

## RS232

Main Menu > Settings > Interfaces > RS232

Softkey 2: Baud rate and end sign

Settings for the baud rate selectable between 1200 and 19200, as well as end sign between CR+LF, CR or LF.

Softkey 3: Data, Parity, Stop bits

The settings for Data (7 or 8), Parity (Even, Odd, None) and Stop bits (1 or 2) can be selected

Softkey 7: RS 232 Protocol

The protocol from the RS 232 can be chosen between: Legacy size, Diagnostic, and ASCII code.

## Define PLC outputs

Main Menu > Settings > Interfaces > Define PLC outputs

The following relay outputs are available for further signal processing. The maximum rating for the relay contacts is 60 V a.c./1 A.

The contacts are numbered from bottom to top.

**CAUTION:**

All pins of digital I/O, digital out and recorder must not be connected with voltages higher than 60 V d.c./25 V a.c. (to grounding equipment conductor) or reach this threshold.

**Table 21 PLC outputs**

Pin	Assignment
1	PLC in free selectable
2	PLC in free selectable
3	PLC in free selectable
4	GND
5 to 7	Digital out free selectable, 5 centre contact, 6 normally open contact, 7 normally closed contact
8 to 10	Digital out free selectable
11 to 13	Digital out free selectable
14 to 16	Digital out free selectable

Description of the operation mode of the Digital Out. The pin assignment for contacts 8 to 16 follows the same order as for pins 5 to 7.

The actual pin setting can be seen under Info / View internal data.

The following digital out signals are selectable.

## Trigger 1; Trigger 2 and 3 analog Trigger 1

Is open in case Trigger Level 1 is exceeded or the machine is not in condition of measuring.

Zero active:	Is closed in case Zero function is running.
Ready:	Is closed in case machine is in measurement mode (Emission on, no error).
CAL active	Closed when machine is in calibrating routine.
CAL Request	Is opened in case of calibration request. During external calibration a open output indicates that the external calibrated leak has to be closed.
Fail	Open when a error is shown.
Warning	Open when a warning is shown.
Gas ballast	Closed when gas ballast is active.
Open	Open all time.
Close	Closed all time.
Recorder Strobe	Closed in case recorder output is invalid. Only used when record output is set on (leak rate).
Pump down	Open when machine is evacuating the test object.
Standby	Open when machine is in Standby or Vent mode.
Vented	Open when machine is in Vent mode.
Emission on	Open when emission is on.

## Define PLC inputs

Main menu > Settings > Interfaces > Define PLC inputs

These inputs can be used to control the ELD500 with a programmable logic control (PLC).



**CAUTION:**  
Maximum input voltage 35 V.

**Table 22 PLC inputs**

Pin	Assignment
1	PLC in free selectable
2	PLC in free selectable

**Table 22 PLC inputs**

Pin	Assignment
3	PLC in free selectable
4	PLC GND

Description of operation mode of the Digital In.

The contacts are numbered from bottom to top.

The PLC inputs are working only if the correct location of control has been set.

The actual pin setting can be seen under Info / View internal data.

Zero:	Change from low to high: activate zero Change from high to low: deactivate zero
Start:	Change from low to high: activate START
Stop:	Change from low to high: activate STOP When this inlet is longer high than chosen then ventilate it additionally.
Purge/gas ballast:	Change from low to high: activate purge/gas ballast Change from high to low: deactivate purge/gas ballast
Clear:	Change from low to high: confirm error message
CAL:	Change from low to high: When machine is in standby mode: start internal calibration. In case machine is measurement mode: start external calibration. (Premise: external calibration test leak has to be open and leak rate signal is stable) Change from high to low: External calibration: approve that external test leak is closed and leak rate signal is stable. High means: $U > 13 \text{ V}$ (approximately 7 mA) Low means: $U < 7 \text{ V}$ The level of the logic signals must not exceed 35 V.
CAL internal	Change from low to high: The Machine starts an internal calibration independent from the mode the machine is running in.
CAL external	Change from low to high: The machine starts an external calibration independent from the mode the machine is running in. Change from high to low: approve that external test leak is closed and leak rate signal is stable.

Signals at these inputs are only accepted if the location of control is set to PLC, All or Local and PLC.



## Scaling recorder output

Main menu > Settings > Interfaces > Scaling recorder output

Here the scaling of the recorder output can be adjusted. This adjustment is possible only when the signal LR lin or LR log is chosen.

- Softkey 2: The decade of the upper leak rate can be decreased.
- Softkey 3: Decrease scaling of the previously adjusted value in steps of 0.5, 1, 2, 2.5, 5, 10 Volt/decade. The complete array covers 10 V.
- Softkey 5: Help text.
- Softkey 6: The decade of the upper leak rate can be increased.
- Softkey 7: Increase scaling of the previously adjusted value in steps of 0.5, 1, 2, 2.5, 5, 10 Volt/decade. The complete array covers 10 V.

Example:

Upper limit value is adjusted to  $10^{-5}$  (= 10 V)

Scaled to 5 V /decade

Lower limit value consequently is  $10^{-7}$  (= 0 V)

## PLC sample rate

Main menu > Settings > Interfaces > PLC Sample rate

- Softkey 2: Decreasing the PLC sample rate down to the minimum of 10 ms.
- Softkey 3: Increasing the PLC sample rate to the maximum of 100 ms.

## Operation

By pressing the MENU push button [Figure 12](#) item 13 the main menu will be displayed regardless of the current working mode or status of the ELD500.

The main menu [Figure 23](#) leads the operator to several sub-menus described in the following chapters. The main menu is identical for all ELD500 models.

The next page gives an overview of the entire menu architecture [Figure 23](#).

The overview of the menu architecture corresponds to the ELD500 WET, differing menu points or setting possibilities for the ELD500 DRY and ELD500 FLEX are described in the respective menu point.

## Main menu

The main menu, [Figure 23](#), shows 7 sub-menus. In these sub-menus groups of technical features are put together logically. From here the next levels of the menu tree can be reached.

All following chapters show the path to get to the described menu line right underneath the headline.

**Figure 22 Display: main menu**

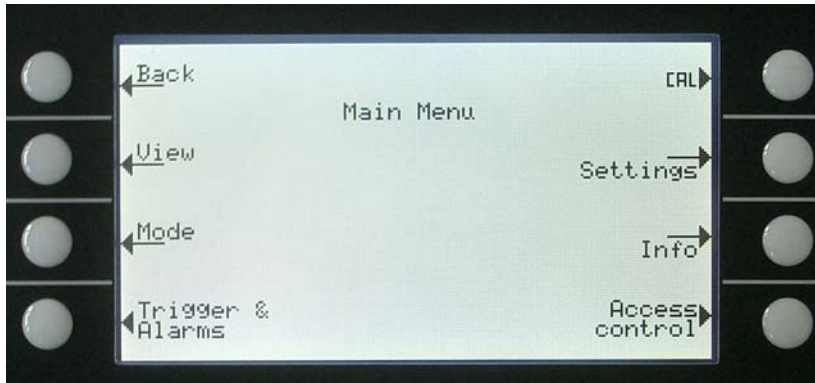

Key No.	Name	Description
1	Back	Return to the previous screen.
2	View	Display settings like scaling, contrast, system background. Refer to <a href="#">View</a> .
3	Mode	Selection of the working modes Vacuum or Sniff. Refer to <a href="#">Mode</a> .
4	Trigger and Alarms	Settings of units, trigger levels and alarms. Refer to <a href="#">Mode</a> .
5	Calibration	Calibration of the ELD500. Refer to <a href="#">Calibration</a> .
6	Settings	Settings of internal machine parameters. Refer to <a href="#">Settings</a> .
7	Information	Information on the ELD500 (electrical and vacuum data) and service menu. Refer to <a href="#">Information</a> .
8	Access Control	Access restrictions. Refer to <a href="#">Access control</a> .

**Figure 23 Overview menu structure**



Main Menu	View	Scale linear / logarithmic		
		Display range		
		Time axis		
		Contrast		
		Background in standby		
		Lower display limit		
	Mode	Sniff/Vacuum		
	Trigger & Alarms	Trigger Level 1		
		Trigger Level 2		
		Trigger Level 3		
		Units		
		Volume		
		Alarm delay		
		Audio alarm type		
	Calibration	internal		
		external		
	Settings	Vacuum settings	Vent delay	
			Vacuum ranges	
			Partial flow setup/pump setup	
			Sniffer factor	
			Machine factor	
			Leak rate internal test leak	
			Purge in measurement	
		Filter & Background	Background suppression	
			Calculate inlet area background	
			Leak rate filter	
		Mass		
		Interfaces	Location of control	
			Define recorder output	
			RS232	
			Define PLC outputs	
			Define PLC inputs	
			Scaling recorder output	
			PLC sample rate	
		Miscellaneous	Time & Date	
			Language	
			Calibration request	
			Service internal forepump	
			Service internal exhaust oil filter	
	Parameter save / load	Service message exhaust oil filter		
Load parameter set				
Monitoring functions	Pressure limits for sniff mode			
	Maximum evacuation time			
	Pressure limits for vacuum mode			
Information	View settings			
	View internal data			
	Vacuum diagram			
	View error list			
	Calibration history			
	Calibration factors			
	Service			
Access Control	Access to CAL function			
	Change Device-PIN			
	Change Menu-Pin			
	Zero			

## View

Main menu > View

In this menu, [Figure 24](#), all features that influence the data display are put together.

**Figure 24** Display: view menu

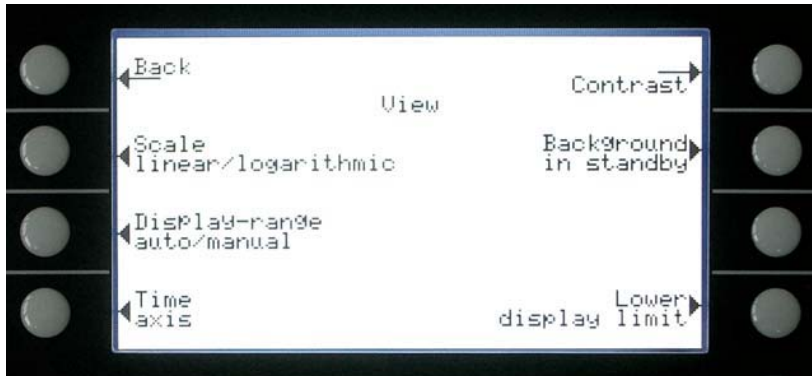

Key no.	Name	Description
1	Back	Return to the main menu.
2	Scale linear/logarithmic	Settings for bar graph and trend mode. Refer to <a href="#">Scale linear/logarithmic</a> .
3	Display range auto/manual	Manual or automatic scaling. Refer to <a href="#">Display-range auto/manual</a> .
4	Time axis	Time axis in trend. Refer to <a href="#">Time axis</a> .
5	Contrast	Display contrast. Refer to <a href="#">Contrast</a> .
6	Background in standby	Background displayed or not. Refer to <a href="#">Background in standby</a> .
8	Lower display limit	Setting of the display limit. Refer to <a href="#">Lower display limit</a> .

## Scale linear/logarithmic

Main menu > View > Scale linear/logarithmic

These settings apply to the bar graph (= bar underneath the digital figures in the measurement mode) and Y-axis in the trend diagram.

The scale of the bar graph can either be linear or logarithmic. With the arrows (↑ and ↓) it can be determined how many decades the bar graph and Y-axis are covered. Usually a logarithmic scale is recommended because leak rates may change easily over several decades. Default setting is logarithmic with 4 decades.

Softkey 2:            Linear

Pressing this key switches the display to a linear scale, starting at zero.

Softkey 3:            ↓ (Number of decades)

Pressing this key reduces the number of displayed decades. The minimum value is 2 decades. Only available if log (softkey 6) was chosen.

Softkey 6:            Logarithmic

The scaling will be displayed logarithmically.

Softkey 7:            ↑ (Number of decades)

Increase the number of displayed decades. Maximum value is 9 decades. Only available if log (softkey 6) was chosen.

## Display-range auto/manual

Main menu > View > Display range auto/manual

The upper limit of the displayed leak rate range can be set manually or automatically. These settings apply to the bar graph (= bar underneath the digital figures in the measurement mode and y-axis in the trend mode).

With the upper limit defined here the lower limit is set to a value based on the number of decades.

Softkey 2:            Manual

The upper limit of the displayed range can be set manually.

Softkey 3:            ↓

Decrease the upper limit if manual is chosen. The minimum value is  $10^{-11}$  mbar l/s

Softkey 5:            ?

Help text

Softkey 6:            Automatic

The limit of the displayed range will be chosen automatically.

Softkey 7:            ↑

Increase the upper limit if manual is chosen. The maximum value is  $10^3$  mbar l/s

Softkey 8:

Save the settings and return to the previous menu.

If linear scale is selected, the lower limit is always zero. The upper limit is only a default value. This can be changed on the measurement screen with the Softkey 6 and 7 if manual display ranging has been selected.

## Time axis

Main menu > View > Time axis

The length of the time axis in trend mode can be changed in given steps between 16 and 960 seconds.

Softkey 3: ↓

Decrease the length of the time axis. The minimum value is 16 seconds.

Softkey 5: ?

Help text

Softkey 7: ↑

Increase the length of the time axis. The maximum adjustable value is 960 seconds.

## Contrast

Main menu > View > Contrast

The contrast of the display can be changed. The recommended value under regular conditions is about 50 (default setting).

Softkey 3: ↓

Fade the contrast to dark. The minimum values is 0.

Softkey 4: Invert display

Invert the contrast of the screen, that means background dark and font bright.

Softkey 5: ?

Help text

Softkey 7: ↑

Fade the contrast to light. The maximum value is 99.

If by accident the display has been set too bright or too dark so that it can not be read off, this may be changed as follows:

Switch off the ELD500 and turn it on again. During the run-up phase press the key no. 3 or 7 so long until the display can be read properly again. This setting is saved to the EPROM only after confirming this through the contrast menu. If this setting is not confirmed, the former setting will be applied after switching on the instrument on again.

## Background in standby

Main menu > View > Background in standby

The internal background leak rate can be displayed in standby mode or not. The default setting is OFF.

Softkey 3: Off

The background leak rate will not be shown.

Softkey 5: ?

Help text.

Softkey 7: On

The background leak rate will be shown.

The internal background is generated by residual gas (e. g. helium) that has not been pumped away yet. Sources for residual gas are air or absorbed gases from the inner surfaces of the ELD500. This internal background will never disappear totally. Very clean systems which have been pumped for a long time will show a background in the  $10^{-11}$  mbar l/s range. Under normal conditions the background level is in the  $10^{-10}$  mbar l/s or low  $10^{-9}$  mbar l/s range.

When pressing START the current internal background is subtracted from all further measured signals automatically. Thus it is made sure that only the net leak rate from the part under test is measured.

When switched to standby/Vent again a new internal background is calculated after 25 seconds. The updated value is underlined. This means that if START is pressed when the value is underlined, the actual background signal will be subtracted. If START is pressed when the value is not underlined, the old background signal from the last standby will be subtracted.

## Lower display limit

Main menu > View > Lower display limit

This mode limits the lower detection limit of the measured leak rate. This is valid for vacuum mode only.

Softkey 3, 7:  $\uparrow \downarrow$

Changing of the lower detection limit between  $1 \times 10^{-9}$  and  $1 \times 10^{-12}$  mbar l/s.

The lower limit for the ELD500 DRY ranges between  $1 \times 10^{-9}$  and  $1 \times 10^{-11}$  mbar l/s.

Softkey 5: ?

Help text

## Mode

Main menu > Mode

The mode menu [Figure 25](#) enables the sub-menu to select the different working modes.

**Figure 25 Display: mode menu**

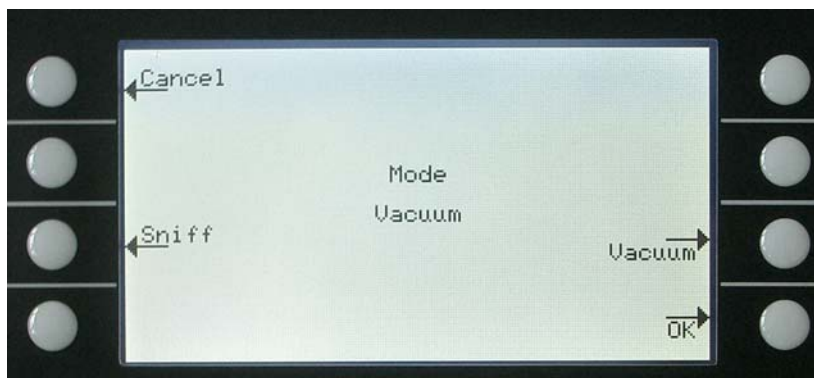



Key No.	Name	Description
1	Cancel	Return to the main menu without any changes of the present settings.
3	Sniff	The sniffer mode will be used.
7	Vacuum	The vacuum mode will be used.
8	OK	Save the settings and return to the previous menu.

## Trigger and alarms

Main menu > Trigger & Alarms

The trigger levels, the volume of the loudspeaker and the units of leak rates and pressures can be set in this menu [Figure 26](#).

**Figure 26** Display: trigger and alarms menu

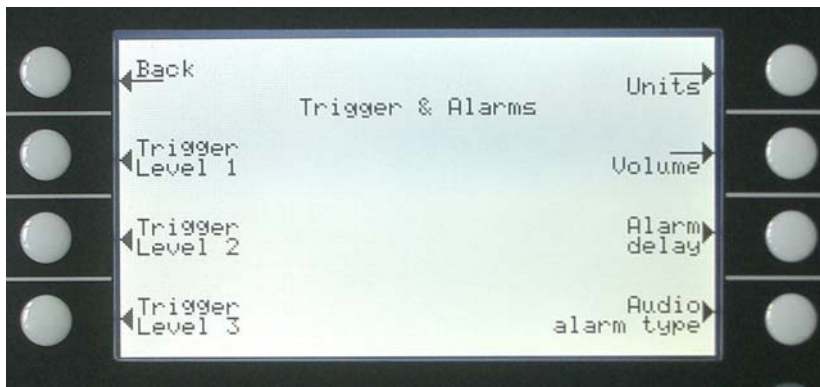

Key No.	Name	Description
1	Back	Return to the main menu.
2	Trigger level 1	Definition of Trigger level 1. Chapter 3.8.1
3	Trigger level 2	Definition of Trigger level 2. Chapter 3.8.2
4	Trigger level 3	Definition of Trigger level 2. Chapter 3.8.3
5	Units	Selection of leak rate and pressure units. Refer to Chapter 3.8.4
6	Volume	Refer to Chapter 3.8.5
7	Alarm delay	Refer to Chapter 3.8.6
8	Audio alarm type	Choice of different alarm types. Refer to Chapter 3.8.7

### Trigger level 1

Main menu > Trigger and Alarms > Trigger level 1

The value of the first trigger level can be set. See Numerical entries for the description of the entry.

Trigger 1, 2 and Trigger 3 are programmable switching thresholds. When these thresholds will be exceeded the ELD500 reacts as follows:

Display	In the status line of the display the signs for Trigger 1, 2 and Trigger 3 are displayed inverted if the leak rate exceeds (becomes higher than) the programmed value (see <a href="#">Figure 10</a> ).
Relay Output	The trigger-relays of the digital out switches. Refer to <a href="#">Interfaces</a> , for further details.
Alarm/Loudspeaker	Additionally Trigger level 1 defines at which level the various alarm types react (see <a href="#">Audio alarm type</a> )

## Trigger level 2

Main menu > Trigger and Alarms > Trigger level 2

The value of the second trigger level can be set. Refer to Numerical entries for the description of the entry.

If Trigger 2 is exceeded the corresponding relay will switch. This is also indicated at the display (see [Trigger level 1](#)).

## Trigger level 3

Main menu > Trigger and Alarms > Trigger level 3

The value of the third trigger level can be set. Refer to Numerical entries for the description of the entry.

If Trigger 3 is exceeded the corresponding relay will switch. This is also indicated at the display (see [Trigger level 3](#)).

## Units

Main menu > Trigger and Alarms > Units

The preferred leak rate unit can be selected. There is the choice of 4 (mbar, Pa, Torr, atm) pressure units and 5 leak rate units (mbar l/s, Pa m<sup>3</sup>/s, Torr l/s, atm cc/s, s ft<sup>3</sup>/yr).

In Sniff mode the following measuring units are selectable: ppm, g/a eq (helium leak rate is equivalent with leak rate R134a), oz/yr eq (helium leak rate is equivalent with leak rate R134a).

Softkey 2:           ↑

Scroll up to select a pressure unit.

Softkey 3:           ↓

Scroll down to select a pressure unit.

Softkey 6:           ↑

Scroll up to select a leak rate unit.

Softkey 7:           ↓  
Scroll down to select a leak rate unit.

## Volume

Main menu > Trigger and Alarms > Volume

The minimum loudness and the actual volume of the loudspeaker can be adjusted.

The minimum loudness is the minimum speaker volume that cannot be exceeded to even lower values. Thus it is avoided that the actual volume is accidentally adjusted to a value that is below the noise level of the environment.

The actual volume can be adjusted between 15 (maximum) and the value defined as minimum loudness.

Softkey 2:           ↓  
Decrease the minimum loudness. The minimum value is 0.

Softkey 3:           ↓  
Decrease the actual volume. The minimum value is limited by the minimum volume.

Softkey 4:           Beep off / Beep on

Softkey 5:           ?  
Help text.

Softkey 6:           ↑  
Increase the minimum volume. The maximum value is 15.

Softkey 7:           ↑  
Increase the regular volume. The maximum value is 15.

## Alarm delay

Main menu > Trigger and Alarms > Alarm delay

In some applications (for instance during pump down in a „chamber test system“) it might be necessary to block an alarm for some time after pressing START.

This delay time of the alarm can be changed.

Softkey 3:           ↓  
Decrease the delay time. The minimum value is 0 seconds.

Softkey 5:           ?  
Help text.

Softkey 7:           ↑

Increase the delay time. The maximum value is 10 minutes up to infinity.

After pressing START the loudspeaker is activated as soon as the leak rate drops below trigger level 1 or after the entered alarm delay time has elapsed. This setting is only active for the audio alarm types SETPOINT and TRIGGER ALARM (See [Audio alarm type](#)).

## Audio alarm type

Main menu > Trigger and Alarms > Audio alarm type

The audio alarm type can be chosen.

Softkey 2: Pinpoint

This function is for localization of a known leak rate value.

Softkey 3: Leak rate prop.

The sound will be proportional to the leak rate signal.

Softkey 5: ?

Help text

Softkey 6: Setpoint

The sound will be proportional to the leak rate signal only if trigger 1 is exceeded.

Softkey 7: Trigger alarm

An alarm sounds when the trigger 1 is exceeded.

### Pinpoint

The tone of the acoustical signal changes its frequency only in a leak rate-window, [Figure 27](#), which ranges from one decade below the Trigger level 1 up to one decade above the Trigger level 1. Below the window the tone is constantly low, above the window it is constantly high.

Example: The Trigger level 1 is  $4 \times 10^{-7}$  mbar l/s. So the window where the tone changes reaches from  $4 \times 10^{-8}$  mbar l/s up to  $4 \times 10^{-6}$  mbar l/s.

**Figure 27 Pinpoint: change of the frequency in the leak rate window (TR1=Triggerlevel 1)**

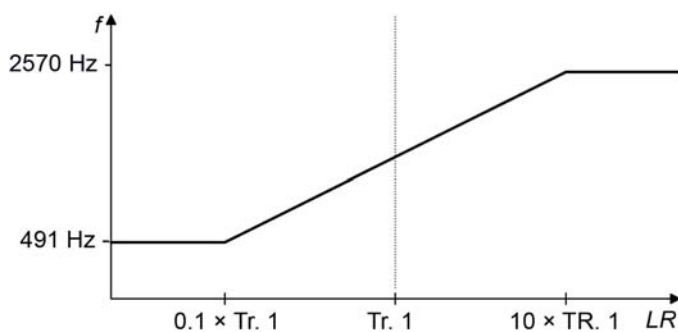

Leak rate prop.

The frequency of the acoustic output is proportional to the reading on the bar graph display. The frequency ranges from 300 to 3300 Hz. Refer to [Scale linear/logarithmic](#) for the definition of the number of decades.

## Setpoint

The tone is off as long as the leak rate is below the Trigger level 1. Above Trigger 1 the tone varies proportional to the leak rate, [Figure 28](#).

**Figure 28 Setpoint: change of the frequency above the trigger level 1 (TR1= Trigger level 1)**

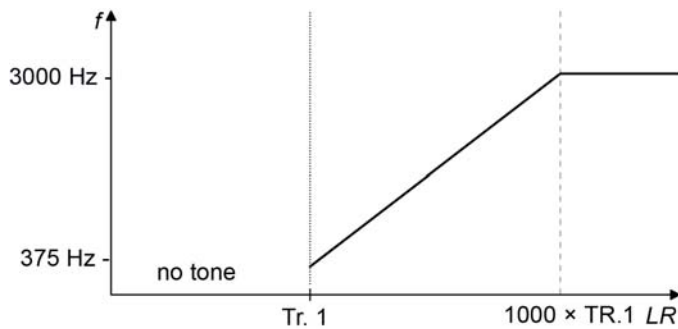

## Trigger alarm

As soon as the leak rate increases above trigger level 1, a multi-tone signal is generated. The tone does not vary with the leak rate.

## Calibration

Main menu > Calibration

In the menu Calibration, [Figure 29](#), the selection between internal and external calibration can be chosen.

Refer to [Calibration](#) for a detailed description of the calibration.

**Figure 29 Display: calibration menu**

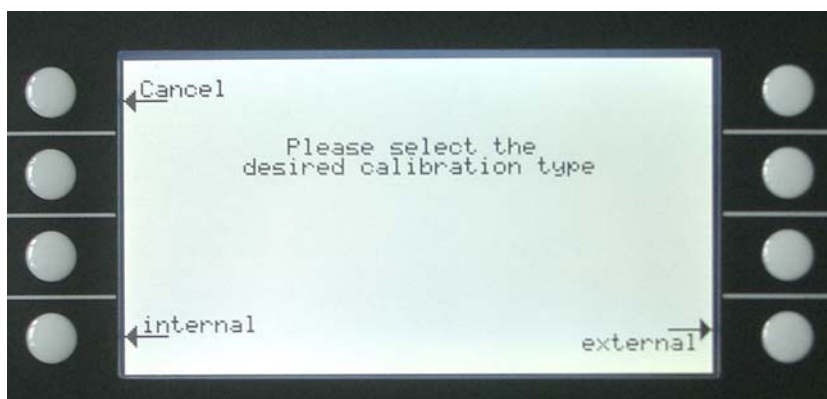

## Settings

Main menu > Settings

This menu, [Figure 30](#), allows to observe and to change the adjustment of the internal machine settings.

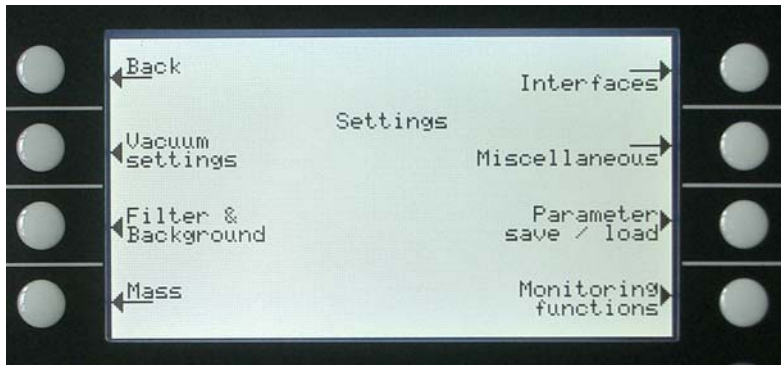
**Figure 30 Display: settings menu**

Key No.	Name	Description
1	Back	Return to the main menu.
2	Vacuum settings	Settings of vacuum system related functions (see <a href="#">Vacuum settings</a> ).
3	Filter and Background	See <a href="#">Filter and background</a> .
4	Mass	Switching between Helium and Hydrogen (see <a href="#">Mass</a> ).
5	Interfaces	Settings for electrical communication and selection for control location (see <a href="#">Interfaces</a> ).
6	Miscellaneous	Settings like date or time (see <a href="#">Miscellaneous (language, calibration request, service interval...)</a> ).
7	Parameter save / load	Store and load sets of parameters (see <a href="#">Parameter save/load</a> ).
8	Monitoring functions	Choose functions of protection of the ELD500 in this mode (see <a href="#">Monitoring functions</a> ).

## Vacuum settings

### ELD500 WET

Main menu > Settings > Vacuum settings

This menu allows to observe and to change the settings belonging to the vacuum system.

Softkey 3: Vent delay

Definition of delay time until the ELD500 is vented

Softkey 4: Vacuum ranges

Selection of the vacuum working modes

Softkey 5: Partial flow setup/Forepump setup

Selection of partial flow mode and fore-pump type

Softkey 6: Sniffer factor

Setting for the sniffer factor

Softkey 7: Machine factor

Setting for the machine factor

Softkey 8: Leak rate internal test leak

Setting for the internal test leak

#### ELD500 DRY

The menu for the ELD500 DRY version allows the following vacuum settings which varies to the ELD500:

Softkey 3: Vent delay

Definition of delay time until the ELD500 is vented

Softkey 4: Vacuum ranges

Selection of the vacuum working modes

Softkey 5: Purge in measurement

The purging during measurement mode can be switched on

Softkey 6: Sniffer factor

Setting for the sniffer factor

Softkey 7: Machine factor

Setting for the machine factor

Softkey 8: Leak rate internal test leak

Setting for the internal test leak

#### ELD500 FLEX

The menu for the ELD500 FLEX version allows the following vacuum settings which varies to the ELD500:

Softkey 2: Automatic purge

Definition of automatic purge function in standby

Softkey 3: Vent delay

Definition of delay time until the ELD500 is vented

Softkey 4: Vacuum ranges

Selection of the vacuum working modes

Softkey 5: Partial flow setup/Fore-pump setup

Selection of partial flow mode and fore-pump type

Softkey 6: Sniffer factor

Setting for the sniffer factor

Softkey 7: Machine factor

Setting for the machine factor

Softkey 8: Leak rate internal test leak

Setting for the internal test leak

### Automatic purge

Main menu > Settings > Vacuum settings > Automatic purge

Through this menu is it possible to start automatic purge for 20 seconds automatically.

This setting is only possible for the ELD500 FLEX (refer to [Vacuum settings](#)).

Softkey 3: Off

The function automatic purge is off.

Softkey 6: ON

The function automatic purge is on. When changing from measure to standby the vacuum fore-pump will be purged automatically for 20 seconds.

### Vent delay

Main menu > Settings > Vacuum settings > Vent delay

Through this menu item it is possible to define the delay time until the inlet port is vented when operating the STOP button. When the STOP button is pressed for a period of time which is shorter than the delay time specified here, the ELD500 will just change to standby mode.

When the STOP button is pressed for a period of time which is longer than the delay time specified here, the ELD500 will vent the inlet port.

Softkey 2: Immediately

The inlet port will be vented immediately after pressing the STOP button.

Softkey 3: After 1 second

The inlet port will be vented with a time delay of 1 second.

Softkey 4: After 1.5 seconds

The inlet port will be vented with a time delay of 1.5 second.

Softkey 5: ?

Help



Softkey 6: after 2 seconds

The inlet port will be vented with a time delay of 2 second.

Softkey 7: No venting

The inlet port cannot be vented with the STOP button.

### Vacuum ranges ELD500 DRY/ELD500 FLEX

Main menu > Settings > Vacuum settings > Vacuum ranges

Different modes concerning the activity of leak detection can be adjusted with this menu. This setting is only active in vacuum mode (see [Interfaces](#)).

Softkey No. 2: GROSS only

In this mode the ELD500 remains at the inlet flange after falling below 15 mbar. When the pressure is increasing over 15 mbar the ELD500 switches automatically into evacuation mode. The smallest detectable leak rate is  $1 \times 10^{-8}$  mbar l/s.

Softkey No. 3: FINE only

In this mode the ELD500 remains after falling below 0,2 mbar at the inlet flange. Valve V1 will be closed. When the pressure at the inlet flange is increasing > 0.2 mbar the ELD500 switches immediately into evacuation mode. The advantage of FINE only is that while this mode is running no valve will switch and the ELD500 has a high pumping speed.

Softkey No. 4: GROSS only 920 Hz

In this mode the turbo pump of the ELD500 works at reduced speed. Therefore the smallest detectable leak rate is  $3 \times 10^{-9}$  mbar l/s. This function can be used to replace the ELD500 in Gross only mode equivalent.

Taste No. 5: ?

Help text

Softkey No.6 Partial flow enable

If the ELD500 or the ELD500 FLEX is used with a partial flow adaptor this vacuum mode must be enabled before. The setup for the partial flow mode is described in partial flow setup.

Softkey No. 7: Normal (default settings)

This is the default setting. The activity runs as explained in [Vacuum diagram ELD500 WET](#).

### Vacuum ranges ELD500 DRY

The ELD500 DRY allows the vacuum ranges as follows:

Softkey No. 2: GROSS only

In this mode the ELD500 DRY remains at the inlet flange after falling below 15 mbar. When the pressure is increasing over 15 mbar the ELD500 DRY switches automatically into evacuation mode. The smallest detectable leak rate is  $1 \times 10^{-8}$  mbar l/s.

Softkey No. 3: FINE only

In this mode the ELD500 DRY remains after falling below 0.1 mbar at the inlet flange. Valve V1 will be closed. When the pressure at the inlet flange is increasing  $> 0.1$  mbar the ELD500 DRY switches immediately into evacuation mode. The advantage of FINE only is that while this mode is running no valve will switch and the leak detector has a high pumping speed.

Softkey No. 4: GROSS only 920 Hz

In this mode the turbo pump of the ELD500 works at reduced speed. Therefore the smallest detectable leak rate is  $3 \times 10^{-9}$  mbar l/s. This function can be used to replace the ELD500 in Gross only mode equivalent.

Taste No. 5: ?

Help text

Softkey No. 6: Precision

In this mode the ELD500 DRY achieves the maximum sensitivity.

Softkey No. 7: Normal (default settings)

This is the default setting. The activity runs through the vacuum ranges from GROSS to FINE.

## Partial flow setup/pump setup

Main menu > Settings > Vacuum settings > Partial flow setup/pump setup

Through this menu item the settings for a use of a partial flow adaptor can be set. In the partial flow mode the test sample is additionally evacuated by an auxiliary pump, which offers the advantage of measuring from 1000 mbar on.

## Enable partial flow mode

Before setting up the parameters the partial flow mode has to be enabled in the main menu under Settings > Vacuum settings > Vacuum ranges with Softkey no. 6 partial flow enable and confirm with the Softkey OK.

This setting is not possible for the ELD500 DRY version.

The ELD500 FLEX allows additionally the settings for the fore-pump (oil sealed or dry) and selectable pumping speed for the fore-pump.

## Partial flow setup for the ELD500 WET/DRY

Softkey 2: ↓

The entry of the nominal pumping speed of the partial flow pump can be decreased. The minimum pumping speed is  $4 \text{ m}^3/\text{h}$ .

Softkey 3: ↓

Decrease Quick-pump time. The quick-pump time defines whether and how long valve V10 of the partial flow block is opened. (For detailed descriptions, refer to the operating instructions "D13510840" of the partial flow system.)

At  $T_Q = 0$  seconds valve V10 will not be open for the time being. This selection is recommended for large volumes and dirty objects.

At  $T_Q = \text{endless}$  valve V10 will open when pressing start. At an inlet pressure  $p_1 < 15$  mbar the ELD500 DRY switches to measurement mode and display leak rates. This is recommended if it is acceptable to wait for a while until measurement mode is reached and leak rate reading at high inlet pressures are not needed.

With times between 0 and endless V10 is opened and the leak detector tries to reach a inlet pressure of less than 15 mbar within this time  $T_Q$ . When  $T_Q$  has gone by V10 is closed and the ELD500 switches to measurement mode (Helium/Hydrogen comes through the orifice of the partial flow valve block).

Softkey 4: Changing behavior of the valve V8 of the partial flow system

Closed: In partial flow mode valve V8 (see GA.10.277 partial flow system) switches dependent on the inlet pressure

Open: Valve V8 stays open, even when the inlet pressure is low enough

Softkey 5: ?

Help text.

Softkey 6: ↑

Increase the pumping speed of the partial flow pump. The entry of the nominal pumping speed of the partial flow pump can be increased. The maximum pumping speed is  $80 \text{ m}^3/\text{h}$ . Default setting is  $25 \text{ m}^3/\text{h}$ .

Softkey 7: ↑

Increase of the quick-pump time up to the maximum.

### Partial flow setup ELD500 FLEX

Partial flow setup/pump configuration for the ELD500 FLEX:

Before setting up the parameters the partial flow mode has to be enabled in the main menu under Settings > Vacuum settings > Vacuum ranges with Softkey no. 6 partial flow enable and confirm with the Softkey OK.

Softkey 2: Pump setup

Setting for the fore-pump if the ELD500 FLEX is operated with a partial flow adaptor.

Softkey 7: Partial flow setup

Options for setting up the partial flow adaptor.

### Vacuum settings ELD500 FLEX

Fore-pump setup for ELD500 FLEX

Softkey 2:                   ↓

The entry of the nominal pumping speed of the partial flow pump can be decreased. The minimum pumping speed is 4 m<sup>3</sup>/h.

Softkey 3:                   Fore-pump type

The ELD500 FLEX with partial flow adaptor can be operated with a dry fore-pump (for ex. Scroll pump) or a wet fore-pump (oil sealed).

This key is for choosing a dry (Scroll, piston) fore vacuum pump.

Softkey 5:                   ?

Help text

Softkey 6:                   ↑

The entry of the nominal pumping speed of the partial flow pump can be increased. The maximum pumping speed is 80 m<sup>3</sup>/h.

Softkey 7:                   Fore-pump type

The ELD500 FLEX with partial flow system can be operated with a dry (for example, Scroll pump) fore-pump or a wet pump (oil sealed).

This key is for choosing a wet (oil sealed) fore vacuum pump.

### Partial flow setup for the ELD500 FLEX

Softkey 2:                   ↓

The entry of the nominal pumping speed of the partial flow pump can be decreased. The minimum pumping speed is 4 m<sup>3</sup>/h.

Softkey 3:                   ↓

Decrease Quick-pump time. The quick-pump time defines whether and how long valve V10 of the partial flow block is opened. (For detailed descriptions, refer to the operating instructions of the partial flow adaptor.)

At TQ = 0 seconds valve V10 will not be open for the time being. This selection is recommended for large volumes and dirty objects.

At TQ = endless valve V10 will open when pressing start. At an inlet pressure  $p_1 < 15$  mbar the ELD500 switches to measurement mode and display leak rates. This is recommended if it is acceptable to wait for a while until measurement mode is reached and leak rate reading at high inlet pressures are not needed.

With times between 0 and endless V10 is opened and the leak detector tries to reach a inlet pressure of less than 15 mbar within this time TQ. When TQ has gone by V10 is closed and the ELD500 switches to measurement mode (Helium/Hydrogen comes through the orifice of the partial flow valve block).

Softkey 4:                   Changing behaviour of the valve V8 of the partial flow adaptor

Closed: In partial flow mode valve V8 (see instruction manuals for the partial flow adaptor) switches dependent on the inlet pressure

Open: Valve V8 stays open, even when the inlet pressure is low enough

Softkey 5: ?

Help text.

Softkey 6: ↑

Increase the pumping speed of the partial flow pump. The entry of the nominal pumping speed of the partial flow pump can be increased. The maximum pumping speed is 80 m<sup>3</sup>/h. Default setting is 25 m<sup>3</sup>/h.

Softkey 7: ↑

Increase of the quick-pump time up to the maximum.

### Sniffer factor

Main menu > Settings > Vacuum settings > Sniffer factor

The sniffer factor takes into account, after an internal calibration, an external partial flow ratio, for example the SL extender interface or an auxiliary pump with sniffer line connected via T-piece to the leak detector.

During an internal calibration the internal sensitivity of the ELD500 is calibrated. The calculated number is multiplied with the sniffer factor and the result is the sniffer factor for this application.

Softkey 4: Set default value

Setting between the default value 1 for the sniffer line SL extender interface or the correction factor (1000) for the use of the SL extender interface.

### SL extender interface setting

For the use of a ELD500 with a SL extender interface the setting for the SL extender interface under Main menu > Settings > Monitoring functions > Pressure limits for sniff mode has to be chosen.

### Machine factor

Main menu > Settings > Vacuum settings > Machine factor

The machine factor takes into account, after an internal calibration, the ratio between the effective helium pumping rate of the ELD500 and the pumps in the pump system in measurement mode as well as the measurement mode used (GROSS/FINE). Based on an internal calibration only, all measured leak rate would be measured too small. The measured leak rate is multiplied with the machine factor and the result is displayed. This factor is only used for vacuum measurement modes (not for sniff mode). See Numerical entries for the description of the entry.

Since the effective pumping rates are usually not known due to the conductances of the vacuum connections, we recommend the following indirect measurement:

1. Set up the ELD500 for operation.
2. First an internal calibration must be performed with machine factor = 1.
3. Connect an external calibrated leak (for example 2.0 x 10<sup>-6</sup> mbar l/s) to the test chamber.

4. Measure leak rate of the external test leak, for example  $5.0 \times 10^{-8}$  mbar l/ s.
5. The machine factor is the quotient of the desired value and the actual value. Desired value:  $2.0 \times 10^{-6}$  mbar l/ s /  $5.0 \times 10^{-8}$  mbar l/ s = machine factor 40.
6. Set the acquired value in the menu point.
7. Calibrate again internally so that the machine factor is taken over.
8. All signals that are measured in further measurements are multiplied by factor 40 and then shown in the display.

### Leak rate internal test leak

Main menu > Settings > Vacuum settings > Leak rate internal test leak

The value of the internal test leak can be set. See Numerical entries for the description of the entry.

Normally there is no reason to edit the leak rate of the internal test leak besides after a change or a recertification of the internal test leak. A wrong leak rate of the internal test leak will lead to wrong leak rate readings!

### Purge in measurement

Main menu > Settings > Vacuum settings > Purge in measurement

This function is only possible for the ELD500 DRY. In vacuum mode the fore vacuum pump is purged constantly to avoid helium accumulation. If the use of the ELD500 DRY needs the possibility to shut off this function, for example, because of a high helium background in the ambient and no option to connect a hose line with fresh air to the gas ballast port, this function can be shut of here.

If the purge mode in measurement is disabled, some specifications as minimum detectable leak rate, internal background or time constant may degrade.

Softkey 7:            Enable (default)

The fore vacuum pump is purged constantly during the measurement mode to avoid helium accumulation. This setting is the preferred setting and should be used.

Softkey 3:            Disable

This setting enables the purging during measuring mode, all disadvantages listed above may occur. It is recommended to use this setting only in special applications.

## Filter and background

Main menu > Settings > Filter and Background

The type of leak rate filters and background condition can be chosen. The default setting for the leak rate filter is auto.

Softkey 2:            Calculate inlet area background

This function is for assignation of the background in the inlet area.

Softkey 3:            Background suppression

Setting of the internal condition for the background.

Softkey 7: Leak rate filter

The type of leak rate filter can be chosen.

The ELD500 DRY allows the following settings

Softkey 3: Background suppression

Setting of the internal condition for the background.

Softkey 7: Leak rate filter

The type of leak rate filter can be chosen.

### Calculate inlet area background

Main menu > Settings > Filter and Background > Calculate inlet area background

This function calculates the background of the inlet area. The ELD500 has to be in the following conditions:

1. Mode vacuum
2. Mode VENTED (minimum 25 seconds)
3. Inlet port blanked off
4. Minimum 20 minutes since power on

After starting this function the leak detector starts with evacuating the inlet area. Earliest two minutes after start the measured value can be accepted as Background Inlet Area. This value will be saved.

### Background suppression

Main menu > Settings > Filter and Background > Background suppression

Softkey 3: Off

Deactivation of the offset function. Under certain circumstances a positive leak rate can be displayed. This setting should be used by experienced users only because of the high possibilities of measuring wrong leak rates.

Softkey 6: inlet area

Additionally to the internal offset (background) the offset of the inlet area will be subtracted. This function for the inlet area is only possible in standby mode, therefore this value has to be determined with the menu point Calculate Inlet Area Background.

Softkey 7: internal only (default)

With start the ELD500 defines the internal offset (background) and subtracts this value from the leak rate signal, so that just the leak rate is shown in the display. This setting should be used as standard setting for the ELD500.

### Leak rate filter

Main menu > Settings > Filter and Background > Leak rate filter

Softkey 3: Fixed

A leak rate filter with a fixed time constant is used

Softkey 6: Auto

Auto makes sure, that the signals are averaged in optimized time intervals, based on the leak rate intensity. Auto also eliminates noise peaks that are not related to leak rate signals and provides extraordinary short response times for low leak rate signals. This setting should be used for the ELD500.

## Mass

Main menu > Settings > Mass

The requested mass of the measured gas can be selected. The ELD500 must be in standby mode for changing to another mass.

Softkey 2: H<sub>2</sub> (2 amu)

Hydrogen with the mass of 2 amu will be measured.

Softkey 3: <sup>3</sup>He (3 amu)

Isotope of helium with the mass of 3 amu will be measured.

Softkey 7: <sup>4</sup>He (4 amu)

Helium with the mass of 4 amu will be measured. Default setting

After changing the mass a calibration for the selected mass should be done (see [Calibration](#)).

## Miscellaneous (language, calibration request, service interval...)

Main menu > Settings > Miscellaneous

The actual date and time, the preferred language and the mains frequency can be set in this sub-menu.

Softkey 2: Time and Date

Setting of time and date

Softkey 3: Language

Selection of the language

Softkey 4: Calibration request

Setting if the ELD500 should remind for a calibration

Softkey 5: Service interval fore-pump

Setting service time interval fore-pump



Softkey 7: Service interval exhaust oil filter

Setting service time interval exhaust oil filter

Softkey 8: Service message exhaust oil filter

Setting service message exhaust oil filter

## Time and date

Main menu > Settings > Miscellaneous > Time and Date

Time and date can be changed on two subsequent pages. Refer to Numerical entries for the description of the entry.

## Language

Main menu > Settings > Miscellaneous > Language

The preferred language can be selected. The default setting is english. The following languages can be chosen: English, German, French, Italian, Spanish, Chinese, Japanese, Polish, Russian

Softkey 3: ↓

Scrolling down to select the language. Press OK to confirm the selected language.

Softkey 7: ↑

Scrolling up to select the language. Press OK to confirm the selected language.

## Calibration request

Main menu > Settings > Miscellaneous > Calibration request

It can be selected whether the operator is reminded of the fact that a calibration may have become necessary or not. The default value is off.

Softkey 3: Off

The calibration request will be switched off.

Softkey 5: ?

Helptext

Softkey 7: ON

The calibration request will be switched on.

If the calibration request is switched on, a corresponding message will appear when 30 minutes have elapsed after power on or if the temperature of the ELD500 has changed by more than 5 °C (9 °F) since the last calibration.

## Service interval fore-pump

Main menu > Settings > Miscellaneous > Service interval fore-pump

Setting for the service interval of the fore-pump. This setting depends on the use of the ELD500 WET but latest after 4000 running hours or one year the oil in the pump should be

controlled. Contact Edwards for more details on the wet pump (see [Exchanging the oil](#)). This setting is possible for the ELD500 DRY only.

Softkey 3:           ∅

The time for the service interval can be decreased in steps of 500 hours.

Softkey 7:           |

The time for the service interval can be increased in steps of 500 hours to the upper limit of 4000 hours.

### Service interval exhaust oil filter

Main menu > Settings > Miscellaneous > Service interval exhaust oil filter

The service interval for the exhaust oil filter can be entered. This setting is only possible for the ELD500 WET. This setting depends on the use and application of the ELD500 WET and therefore no recommendations can be given (see [Maintenance](#)).

Softkey 3:           ↓

Decrease of the service interval steps of within 500 hours. The limit is 1000 hours

Softkey 5:           ?

Help text

Softkey 7:           ↑

Increase of the service interval within steps of 500 hours. The limit is 4000 hours.

### Service message exhaust oil filter

Main menu > Settings > Miscellaneous > Service message exhaust oil filter

The exhaust oil filter must be maintained at regular intervals to ensure the correct function of the ELD500 WET. If the service message is activated, the ELD500 WET will provide an indication of the required maintenance.

This setting is only possible for the ELD500 WET.

If the service messages are ignored and the exhaust is not replaced a risk for overheating the pump motor exists.

Softkey 3:           ↓

The service message for the oil filter can be reduced to the minimum 1000 hours

Softkey 7:           ↑

The service message for the oil filter can be increased up to the maximum 4000 hours.

### Parameter save/load

Main menu > Settings > Parameter save load

Enables to save and load individual settings or reload the default settings.

Softkey 2 to 4:

The names of the current values can be saved under a free selectable name. The saving of 3 different sets is possible.

Softkey 5: Load default values

The factory settings will be loaded again.

Softkey 6 to 8:

One of three saved parameter sets can be loaded.

### Load parameter set

Main menu > Settings > Parameter save load > Load parameter set

Save the current parameter settings.

Softkey 4: Edit a file name

Rename the parameter set.

Softkey 8: Save

Save the edited parameter set.

### Save parameter set

Main menu > Settings > Parameter save load > Save parameter set

The settings of the selected saved parameter set will be displayed and can be reloaded.

Softkey 6: ↑

Upward to the previous screen.

Softkey 7: ↓

Downward to the next screen.

## Monitoring functions

Main menu > Settings > Monitoring functions

This Submenu explains the monitoring functions.

Softkey No. 3: Maximum evacuation time

Settings for the gross leak measurement

Softkey No. 4: Contamination protection

Set the switch off limit and enable the function

Softkey No. 6: Pressure limits for vacuum mode

Setting for the pressure limits between evacuation, GROSS and FINE mode.

Softkey No. 7:        Pressure limits for sniff mode  
 Definition of the upper and lower limit of the sniffer pressure

### Maximum evacuation time

Main menu > Settings > Monitoring functions > Maximum evacuation time

This menu item is used to define when the gross leak message is to occur. The gross leak detection process operates in two steps and the limits can be adapted as required.

This menu item is particularly useful in series testing under the same conditions at all times.

After pressing the start button the test sample is evacuated. If the pressure conditions ( $p_1 < 100$  mbar) are not attained, or if the pressure does not drop low enough within the periods of time specified here, the pump down process is terminated and the display will indicate a message (see [Troubleshooting](#), W75 and W76).

The periods which are selected in each case depend firstly on the desired reaction time for the gross leak message, and secondly on the volume of the test sample and the effective pumping speed.

If the evacuation time was set to endless, the oil level of the mechanical pump should be checked more often.

Softkey No. 2:        ↓

Decreasing maximum evacuation time until  $p_1 < 100$  mbar. Within this period of time the inlet pressure at the test flange must have dropped below 100 mbar. The duration may be selected freely between 1 second and 9 minutes or can be set to endless. The default is 30 seconds.

Softkey No. 3:        ↓

Decreasing maximum time until measurement. Within the period of this time the status of measurement readiness must have been attained, that is, the inlet pressure must have dropped below 15 mbar. The duration may be freely selected between 5 seconds and 30 minutes or can be set to endless.

Softkey No. 5:        ?

Help text

Softkey No. 6:        ↑

Increasing maximum evacuation time until  $p_1 < 100$  mbar

Softkey No. 7        ↑

Increasing maximum time until measurement.

### Contamination protection

Main menu > Settings > Surveillance > Contamination Protection

If enabled, this mode will cause the ELD500 to close all inlet valves as soon as the measured leak rate exceeds the programmed limit. Once the START key is pressed, the value must drop below the limit once as the function will otherwise be triggered when the alarm delay time has elapsed. This will prevent an excess amount of helium from entering the mass spectrometer. Consequently, the leak detection unit is prevented from becoming

contaminated by helium. The helium entering the specimen can be pumped out using an external pump. If no pump is available, the recommendation is to ventilate the specimen before continuing with the measurements.

Softkey No. 1: Back

Softkey No. 3: Off

Softkey No. 4 Enter limit value

Selection between air or Argon

Softkey No. 5: ?

Help text

Softkey No. 6: On

Softkey No. 7: Off

#### Pressure limits for vacuum mode.

Main menu > Settings > Monitoring functions > Pressure limits for vacuum mode

With this function the default settings for the pressure limits EVAC - GROSS and FINE can be changed.

This might be necessary if other gases than air will be pumped by the ELD500. The pressure signal from the gas dependent inlet pressure (P1) will dump false signals. With changing the pressure limits this performance will be adjusted.

Softkey No. 2: ↓

Decrease change over threshold EVAC-GROSS

Selectable between 15-3 mbar (Default value 15 mbar)

Softkey No. 3: ↓

Decrease change over threshold GROSS-FINE

Selectable between 0.2 to 0.05 mbar (Default value 0.2 mbar). For the ELD500 DRY and the ELD500 FLEX the changeover is between 0.1-0.05 mbar (Default value 0.2 mbar).

Softkey No. 4 Adjustment for ARGON

Selection between air or Argon

Softkey No. 5: ?

Help text

Softkey No. 6: ↑

Increase change over threshold EVAC-GROSS

Selectable between 3 - 15 mbar

Softkey No. 7:       ↑

Increase change over threshold GROSS-FINE

Selectable between 0.05 - 0.2 mbar, respectively 0.05 - 0.1 mbar for ELD500 DRY and ELD500 FLEX

## Pressure limits for sniff mode

Main menu > Settings > Monitoring functions > Pressure limits for sniff mode

This function is automatically activated in sniff mode. The pressure limits define an upper and lower limit of the inlet pressure P1. If the pressure is not in this range error messages are generated:

P > upper limit: Capillary broken

P < lower limit: Flow through capillary too low (Capillary blocked)

Softkey No. 2: -

Decreasing the maximum pressure, upper limit is 0.15 mbar (default)

Softkey No. 3: -

Decreasing the minimum pressure

Softkey No. 4: Setting for SL Extender interface

Setting for use with the SL Extender interface, upper limit is 0.05 mbar, lower limit 0 mbar.

Pushing the button again for default setting.

Softkey No. 6 -

Increasing the maximum pressure

Softkey No. 7: -

Increase the minimum pressure, Lower limit is 0.05 mbar (default)

## Information

Main menu > Information

The Information Menu [Figure 31](#) enables sub-menus to select different kinds of information belonging to the ELD500.

**Figure 31** Display: information menu

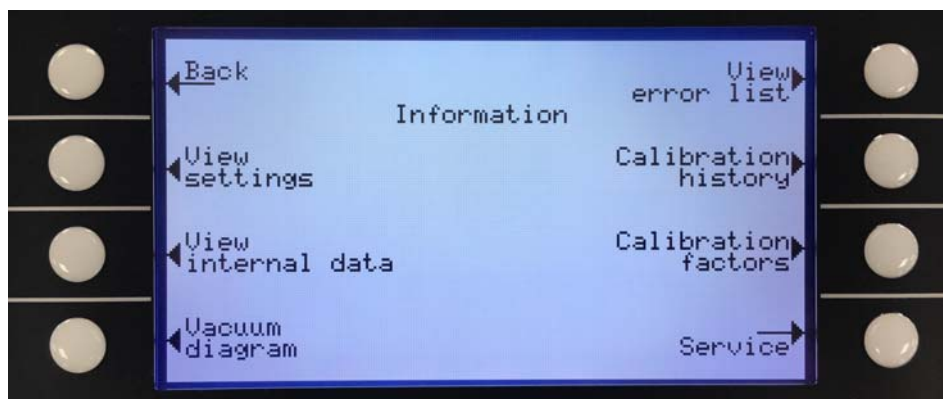

Softkey 2: View settings

The current settings will be displayed on 5 pages, for example trigger levels, test leak mass, date and time.

Softkey 3: View internal data

Information on measured internal data is provided on 10 screens.

Softkey 4: Vacuum diagram

The vacuum diagram of the ELD500 is shown displaying which valves are opened or closed momentarily (See chapter 4.1.1).

Softkey 5: View error list

The list of occurred errors and warnings will be displayed (see [Troubleshooting](#)).

Softkey 6: Calibration history

The carried out calibrations will be listed.

Softkey 7: Calibration factors

The calibration factors for the different masses and the machine factor will be displayed.

Softkey 8: Service

## Service

Main menu > Information > Service

With the main menu special functions can be accomplished (for example, manual switching of the valves). The access to the service menu is protected by a PIN. This PIN is not communicated with the delivery of the leak detector but after an adequate service training.

## Access control

Main menu > Access control

This menu can deny or allow access to specific functions of the ELD500.

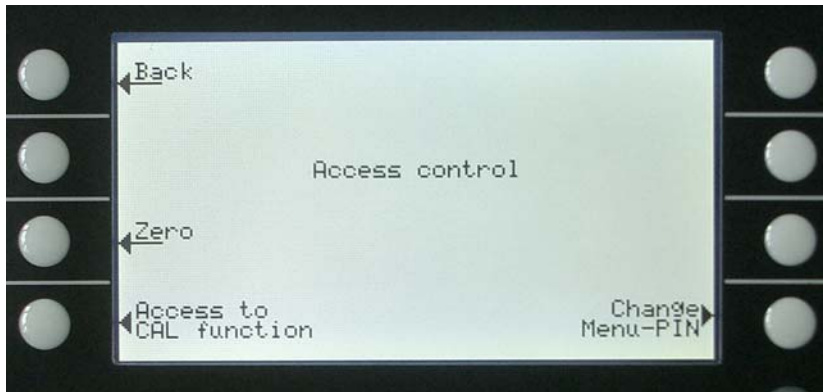

**Figure 32 Display: access control menu**

Softkey 3            Zero

Settings of the zero function

Softkey 4:            Access to CAL function

Settings for restriction of the CAL function

Softkey 8:            Change Menu-Pin

Access to menu pin can be restricted

## Zero

Main menu > Access control > Zero

This setting enables (respectively disables) the ZERO button at the control panel. With ZERO at FINE, the ZERO functions executes automatically as soon as the measuring range FINE is reached for the first time after START. In this mode the ZERO function also can be executed manually via the ZERO button.

Softkey 3:            Disable

ZERO button disabled

Softkey 5:            ?

Help text

Softkey 6:            Zero at FINE

When reaching the FINE mode and leak rate falls below trigger level 3 the ZERO function is started automatically.

Softkey 7:            Enable

Softkey ZERO is selectable. Default setting.

## Access to CAL function

Main menu > Access control > Access to CAL function

It can be selected whether the access to the calibration menu is restricted or not.

Softkey 3: Off

The calibration function is only available at the main menu. If the Menu-PIN (See [Change menu-PIN](#)) is activated, this PIN is required to start a calibration. Default setting.

Softkey 5: ?

Help text

Softkey 7: ON

The calibration function is available at the main menu and in standby and the measure mode.

## Change menu-PIN

Main menu > Access control > Change Menu-Pin

The access to the menu can be restricted by entering or changing the personal identification number (PIN). No PIN will be checked if 0000 is entered.

The default setting for the Pin is 0013.

Refer to Numerical entries for the description of the entry.

## Calibration

### Introduction

The ELD500 can be calibrated in two different ways:

Internal calibration by means of a built-in test leak

or

external calibration by means of an additional test leak which then is attached to the inlet port or the component under test.

During the calibration procedure the mass spectrometer is tuned to the maximum helium or hydrogen signal and this signal is referred to the known leak rate of the internal or external test leak. Although the ELD500 is a very stable instrument a calibration is recommended every day with heavy use, or before using the ELD500 from time to time, to make sure that ambient temperature changes or dirt or other impacts don't adulterate the measurements.

To get an optimized calibration the machine has to warm up at least 20 minutes before use, otherwise a warning will come up which might be ignored.

### The calibration routines

The calibration routines can be started by pressing button CAL (Softkey 5) via 3 different locations:

- main menu ([Figure 23](#))
- standby mode ([Figure 12](#))
- measurement mode ([Figure 10](#))

The access via standby mode or measurement mode can possibly be blocked (see [Access to CAL function](#)). In this case the Softkey is not labelled. Default: Access on.

Once the calibration mode is activated the user must choose between an internal and an external calibration. Press the corresponding Softkey ([Figure 29](#)).

A calibration may be terminated at any time by pressing the Stop button or using the Softkey no. 1 (Cancel) [Figure 34](#).

## Internal calibration

Mass 4 must be selected (Default setting)

Press Softkey no 4 [Figure 29](#) to start the calibration. Once this procedure is started the entire procedure is performed automatically. At the end (after about 25 seconds) a visual and audio signal is released. Thereafter the unit is ready for further use.

## External calibration

For an external calibration a test leak has to be attached to the part under test or the inlet port directly depending on the application.

After External calibration ([Figure 29](#), Softkey no. 8) has been chosen the following messages are displayed and the described actions are required:

**Figure 33 Display: external calibration, Step 1**

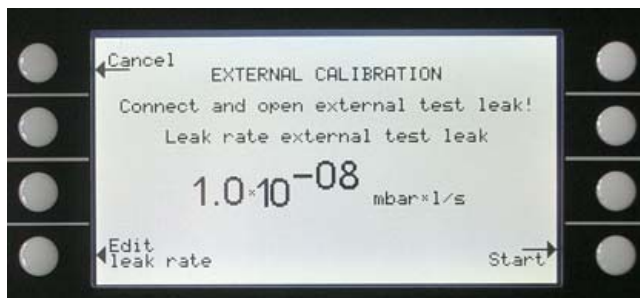

Check the leak rate printed on the test leak and compare it with the leak rate at the display. If the leak rates are not identical press Edit leak rate (Softkey no. 4) and correct the value.

If the leak rates are okay press START (Softkey no. 8).

Make sure that the correct mass is selected.

Make sure that the test leak is connected and opened.

**Figure 34 Display: external calibration, Step 2**

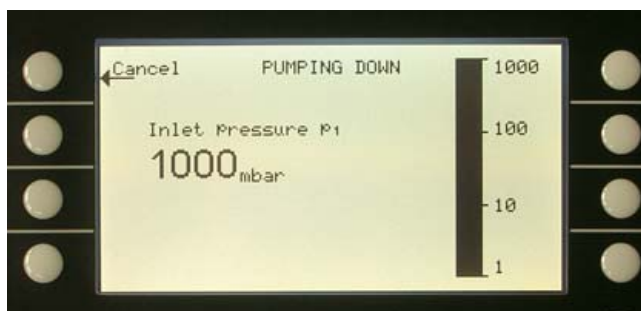

No action required.

**Figure 35 Display: external calibration, Step 3**

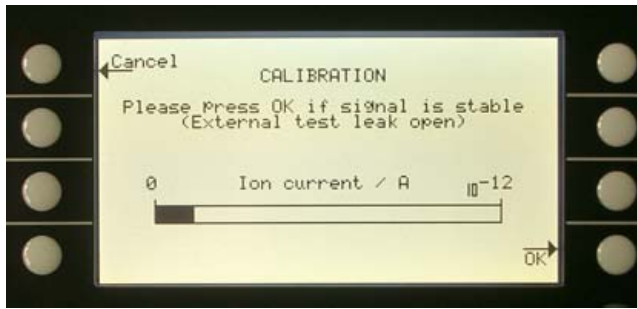

The bar graph display shows a signal which must not vary much. If so, press OK (Softkey no. 8).

**Figure 36 Display: external calibration, Step 4**

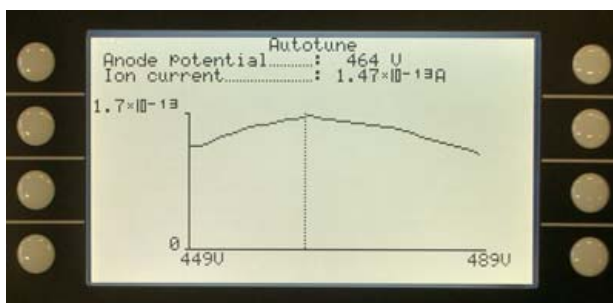

No action required.

**Figure 37 Display: external calibration, Step 5**

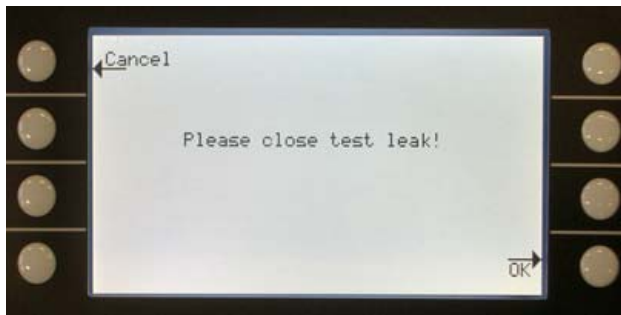

The bar graph display shows a signal which must not decrease any more. There might be a small fluctuation which is okay. If so press OK (Softkey no. 8).

**Figure 38 Display: external calibration, Step 6**

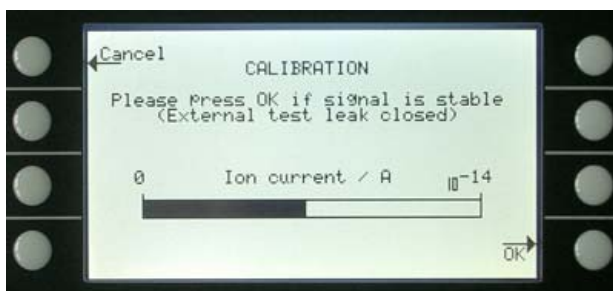

When the signal is stable confirm with o.k.

**Figure 39 Display: external calibration, Step 7**

The ELD500 shows the old and the new calculated calibration factor.

### Factor of calibration - range of values

To avoid a faulty calibration the factor of calibration is tested for plausibility at the end of the calibration routine.

When the new factor of calibration is not considerable higher or lower (< factor 2) than the previous factor of calibration the new factor will be accepted automatically. When the new factor of calibration diverges stronger from the previous factor the user can decide if he wants to accept it anyway (for example, after changing the system configuration) or not (for example, because of maloperation).

When calibration is started via SPS or RS232 no testing for plausibility is occurring.

When calibrating internal it is also monitored if the newly calculated factor of calibration is higher than 10 or lower than 0.1. In this case a warning (see W81 resp. W82 in Chapter 5.2.) is displayed and the calibration will be interrupted.

### Switching off/shutting down

The ELD500 can be switched off any time by using the mains switch. The turbo pump will be decelerated automatically. It is recommended to put the leak detector into standby and vented mode. Approximately after 30 seconds the turbo pump is decelerated sufficient to move the ELD500.



# Maintenance

## Safety information



### **WARNING:**

During all maintenance and connection work, make sure that the mains cable have been reliable disconnected and do not carry a mains voltage. The leak detector must only be used in with the hoods closed. The electrical connections must only be provided by a trained electrician as specified, for example, by the regulations EN 50110-1.

## Maintenance intervals

Maintenance work should be done on the ELD500 as required. This work will normally be limited to exchanging the oil in the wet pump of the ELD500 WET and the built in air and oil filters.

As a preventive measure it is recommended to check the wet pump once a month. Here note should be taken of the oil level and the colour of the oil.

Only Ultragrade 15 (H11026015) must be used in the wet pump in the ELD500 WET.

The monthly interval for the check is just a nominal period. If the ELD500 WET is used heavily, in particular in sniffer mode, then this check should be performed more frequently. The rotary vane pump is located on the side of the mechanical section at the bottom of the leak detector.

## Service

When equipment is returned, indicate whether the equipment is contaminated or is free of substances which could pose a health hazard. If it is contaminated, specify exactly which substances are involved. The form supplied for this purpose must be filled out.

A copy of this form has been reproduced at the end of these Operating Instructions: Declaration of contamination for Compressors, Vacuum pumps and Components.

Attach the form to the equipment or enclose it with the equipment.

This statement detailing the type of contamination is required to satisfy legal requirements and for the protection of our employees.

We must return to the sender any equipment which is not accompanied by a contamination statement.

Before shipping fit the yellow screw-on seals on to the connections EXHAUST and GAS BALLAST.

## Maintenance work

### Opening of the ELD500

Figure 40 Back view of the ELD500

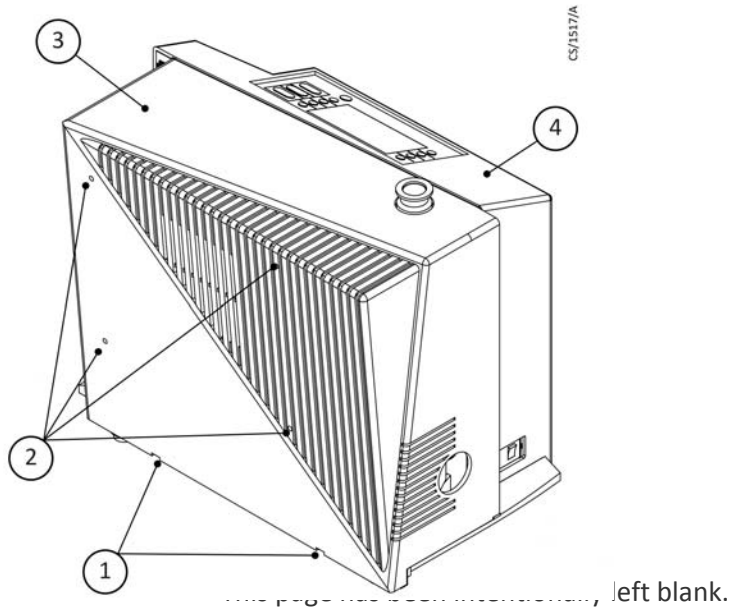

1. Openings for removal of the cover for the mechanical section
2. Four screws for loosening the cover for the electronics section.
3. Mechanical cover
4. Electronic cover

To open the ELD500 follow the next steps:

1. Switch the ELD500 off.
2. Pull the mains cord on the ELD500.
3. Separate the ELD500 from other vacuum components at the test port.

Figure 41 Opening of the mechanical hood

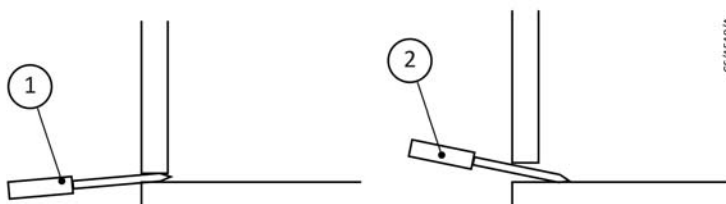

4. Turn the ELD500 so that it is orientated in the same way as shown in [Figure 40](#).
5. Use two flat blade screw drivers and insert these into the openings ([Figure 41](#)) and lever the cover for the mechanical section out at the bottom.



6. In doing so, the cover should be moved somewhat to the front by the downward motion of the screwdrivers. The cover may be lifted up by the upwards motion of the screw drivers so that the cover is disengaged completely.
7. Then pull the cover off the mechanical section up to its stop and remove it to the front.
8. Removing the cover for the electronics section by removing the four Phillips screws (Figure 40 item 2).
9. Pull the cover over the electronics section back to the rear and place it aside.
10. After completion of all maintenance work put the electronic cover back in place and screw it tighten. The cover of the mechanical section must engage properly in the openings at the bottom.

## Exchanging the filter mats

The filter mats have been built in to filter the dust out the air which is taken in. In order to ensure that the filter mats will not throttle the air flow and so that sufficient cooling is possible at all times, the filter mats should be cleaned or exchanged as soon as these have attained a dark grey colour.

Filter mats are used at two places within the ELD500:

1. at the ventilation slit of the electronic cover (only partly visible from the outside)
2. at the fan of the turbo molecular pump (only partly visible from the outside)

To exchange the filter mats remove the covers as described above.

Filter mat a.) these filter mats are screwed to the electronic cover. Unscrew the screws and exchange the filter mats.

Filter mat b) This filter mat is fixed before the fan with a plastic bracket. Take of the bracket and remove the filter, put on the bracket and fix it properly.

Under certain circumstances a dirty mat may be cleaned by shaking the dust out or by using a vacuum cleaner so that the filter mat can be used again.

In the ventilation line is a dust filter installed. This filter has to be cleaned or changed when using in dirty environment.

## Exchanging the oil

Remove the cover of the mechanical section as described in [Opening of the ELD500](#).



### WARNING:

During all maintenance and connection work, make sure that the mains cable have been reliable disconnected and do not carry a mains voltage. The leak detector must only be used in with the hoods closed. The electrical connections must only be provided by a trained electrician as specified, for example, by the regulations EN 50110-1.



### WARNING:

When the pump has been pumping hazardous substances, determined the kind of hazard first and ensure that suitable safety precautions are taken. Observe all safety regulations.

**WARNING:**

When disposing of waste oil, observe the applicable regulations for the safety of the environment. The oil change procedure is described in the following section.

As already stated before only Ultragrade 15 (H11026015) must be used for the wet pump in the ELD500 WET.

After completion of all maintenance work the cover of the mechanical section must engage properly in the openings at the bottom.

## Oil change

**WARNING:**

Pump and operating agents may be contaminated. Hazardous substances may escape from the pump and the oil. If there is the danger that the operating agent may present a hazard in any way due to decomposition of the oil, or because of the media which have been pumped, the type of hazard must be determined and all necessary safety precautions taken. Use gloves, face protection or a respirator if required.

**WARNING:**

Change the oil while the pump is cold so as to avoid releasing adsorbed gases. If releasing adsorbed gases is no problem, change the oil after the pump has been switched off and while the pump is still warm.

**WARNING:**

Risk of suffering burns. With the pump warm from operation, both pump and oil can get so hot that there is the risk of suffering burns. If required, wear gloves.

**Note:**

*Check and top up oil only after having shut down the pump. When disposing of waste oil, observe the applicable environment protection regulations.*

*When changing the oil use the same type of oil which was previously in the pump. If an oil type change is desired, consult Edwards.*

The oil should be changed after the first 100 operating hours and then at least every 2000 - 3000 operating hours or after one year. At high intake pressures and intake temperatures and/or when pumping contaminated gases, the oil will have to be changed much more frequently.

Further oil changes should be made before and after long-term storage of the pump.

Contact us for more information in this matter.

Required tool: Allen key 8 mm.

Remove the oil-drain plug and let the used oil drain into a suitable container. When the flow of oil slows down, screw the oil-drain plug back in, briefly switch on the pump (maximum 10 seconds) and then switch it off again. Remove the oil-drain plug once more and drain out the remaining oil.

Screw the oil drain plug back in (check the gasket and re-install a new one if necessary).

Remove the oil fill plug and fill in with fresh oil.

Screw the oil fill plug back in.

The tightening torque for the bolts has been specified at 10 Nm.

## Cleaning

The housing of the ELD500 is made of painted plastic parts. Thus for the purpose of cleaning, only such agents should be used which are generally also used for other painted or plastic surfaces (mild household cleaning agents, for example). Normally a moistened piece of cloth will do. Never use any solvents which are capable of dissolving paint (like acetone, toluol, and so forth).

A soft brush or a vacuum cleaner is recommended for cleaning the ventilation slits.

## Exchanging the fuses



### WARNING:

**The mains cord must be disconnected before exchanging the fuses.**

1. Switch the ELD500 off.
2. Pull the mains cord off the ELD500.
3. Use a screwdriver to fold out the lid of the mains socket from the right (the mains switch is not affected by this).
4. The fuses can be removed by pulling the drawers out which are marked by the arrows. When reinserting these make sure that the arrows point downwards.
5. In any cases two fuses of the same rating must be inserted. The required mains fuses are: T 10A slow blow (20 x 5 mm dial.) for 100 to 230 V a.c.
6. After having exchanged the fuse (s) press the lid of the mains socket firmly back on.
7. Insert the mains cord into the ELD500 and switch the instrument on.

Beside these mains fuses several internal circuits are fused separately. These fuses are listed in the following table (see [Figure 42](#)).

To exchange these fuses proceed as follows:

1. Switch the ELD500 off
2. Pull the mains cord on the ELD500
3. Remove the cover for the mechanical and electronics section according to [Opening of the ELD500](#).
4. Exchange fuses. As can be seen in [Figure 42](#), fuses 1, 2, 3 and 4 are located on the MSV board, fuses 5 and 6 on the I/O board and the fuses 7, 8, 9 and 10 are located on the wiring backplane under the MSV board.
5. Finally re-install the covers for the electronics and mechanical section in the reverse order.

No 1 F1 on MSV Fuse rating: T 2A	24 V system voltage of the mass spectrometer supply.  Loosen control panel (two Phillips screws). Loosen the panel which holds the MSV board in place (two Phillips screws).  Pull the MSV board (the board at the back) up to the top. For this insert a screwdriver into the two recesses at the sides (top) one after the other and lever the MSV board out by resting the screwdriver on the STE board.
No 2 F2 on MSV	Not in use.
No 3 F3 on MSV Fuse rating: T 1A	For generating 24 V for DCDC-converter (+/- 15 V / 5 V)
No 4 F4 on MSV Fuse rating: M 0,032A	Fuse for the anode voltage
No 5 F1 on I/O board Fuse rating: T 0,8A	Protects the 24 V supply carried by the option socket
No 6 F2 on I/O board Fuse rating: T 0,2A	Protects the selectable 24 V for RS 232 Interface.
No 7 F 1 on MB Fuse rating: T 0,8A	Supply voltage for the remote control
No 8 F 2 on MB Fuse rating: T 4A	Supply voltage 24 V for I/O board.
No 9 F 3 on MB Fuse rating: T 0,8A	Supply voltage 24 V for fans and motor relay.
No. 10 F 4 on MD Fuse rating: T 8A	Protection for the fore vacuum pump.

Figure 42 Assembly fuses

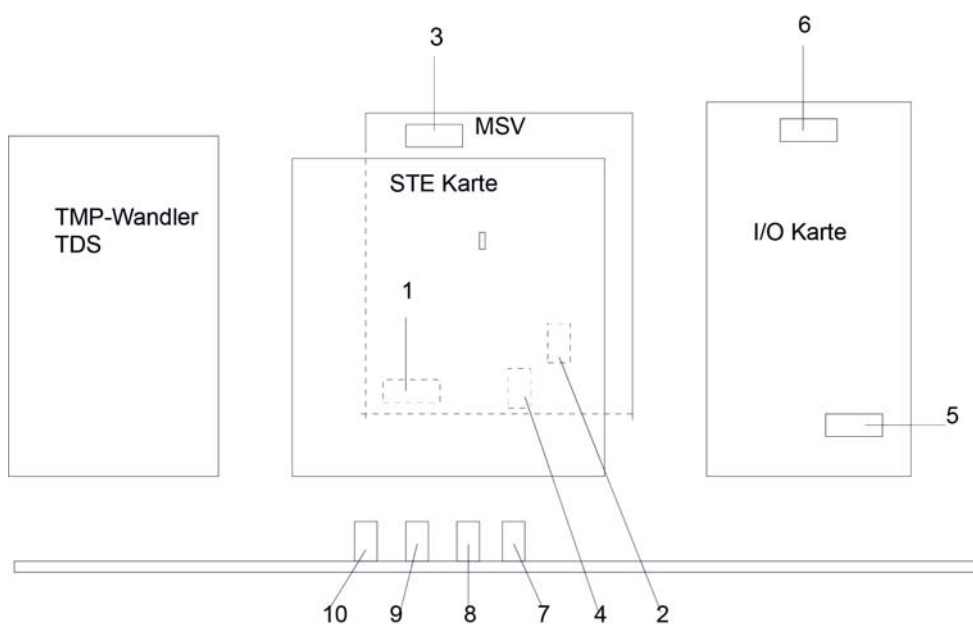

## Exhaust oil filter

After using the ELD500 for a longer time there can be oil accumulated from the pump. Do the following:

1. Switch off the ELD500.
2. Remove the mechanical cover according to [Opening of the ELD500](#).
3. The oil filter is located besides the rotary vane pump.
4. Unscrew the plexiglas cabinet (direction is shown by an arrow on the filter).
5. Clean or replace the filter (xxxxxxxxxx)
6. Screw back the plexiglas cabinet hand tight.
7. Check the oil level of the wet pump and fill it up when necessary (contact Edwards for more details).
8. Finally re-install the cover for the mechanical section.

## Turbomolecular pump

For the turbomolecular pump it is recommended to change the bearings after 20,000 running hours. For details, contact the local Edwards service hub.

## Calibrated leak TL7

The Calibrated leak CL internal with the helium reservoir is used for alignment of the mass spectrometer in the ELD500 as well as for calibration the leak rate indication.

It is equipped with a solenoid valve which is actuated via the control electronics of the ELD500.

## Technical data

Nominal calibration range	10 to 7 mbar l/s
Tolerance of nominal calibration range	+/- 15%
Temperature coefficient	< 0.5%/°C
Leak type	Capillary
Filling	Helium

## Factory inspection

Calibrated leaks are not subject to wear and the Helium loss of the calibrated leak TL7, being less than 2% per year, is negligible. Nevertheless, the leak rate may change over years due to external influences. A factory inspection is, therefore, advisable once a year.

A test certificate, if required for the Helium calibrated leak, can be obtained from Edwards. In that case, the calibrated leak should be forwarded and will be returned inspected and recertified with the test certificate against charge.

The helium flow stated on the main label is the actual leak rate of the calibrated leak.



# Troubleshooting

The ELD500 is equipped with comprehensive self-diagnostic facilities. If an error or warning condition is detected it is indicated via the LC display to the operator.

An audio signal is generated when an error or warning occurs. The frequency changes every 400 ms from 500 to 1200 Hz and vice versa so that the signal stands out well from ambient noises normally encountered.

Error and warning messages are logged and can also be displayed at a later time through the menu information (refer to Information.)

## Hints for troubleshooting

Warnings will be indicated:

- when the ELD500 detects an abnormal condition, or
- when it wants to remind the operator of something (for example, a request for calibration or a service timer has expired).

The ELD500 will indicate a message on the LC display and will remain in the standby or the measurement mode.

Warning messages will remain on the LC display until the warning has been acknowledged by pressing OK (Softkey no. 8). After that the ELD500 can be used again (possibly with some restrictions). As long as a warning status exists the status line shows a warning triangle.

Errors are events which force the ELD500 to interrupt its measurement operations. In this case the ELD500 closes all valves except valve 2a (standby mode).

Error messages remain on the LC display until the message has been acknowledged by pressing Restart (Softkey no. 8). After that, the ELD500 restarts with a new run-up procedure. In some cases it may be helpful to check some settings or measured values before the ELD500 restarts. Therefore it is also possible to press Menu (Softkey no. 4 or Menu key) to enter the ELD500 menu. After leaving the menu the same error message will be displayed again.

Under extreme conditions (unknown software errors, excessively high electromagnetic interference levels) the built-in Watchdog circuit will prevent uncontrolled operation of the ELD500. This Watchdog will cause the ELD500 to restart. After having done so, the instrument will be running in the standby mode. No error message will be output.

## List of errors and warnings

The following pages contain a list of all errors and warnings displayed at the control panel. Warning messages are indicated by numbers with a leading W. Error messages are indicated by numbers with a leading E.

Table 23 Fault finding

No.	Displayed message	Description and possible solutions
W14	Exhaust oil filter service interval expired	The chosen service interval for the exhaust oil filter is expired.
		Control and/or replace the exhaust filter insert.
W17	Fore pump service interval expired!	The service interval for the fore pump is expired.
		Service the fore pump
W21	EEPROM write time out	EEPROM defective
		MC 68 defective
W22	EEPROM parameter queue overflow	Software problem, contact Edwards service.
E23	24 V for external output 1 is too high.	The 24 V voltage for the external output 1 is too high
		Check if an external voltage has been applied to the 24 V output.
E24	24 V for external output 1 is too low.	The 24 V voltage for the external output 1 is too low.
		Fuse F2 on the wiring backplane has blown
E25	Lowered valve voltage too low (< 7V).	I/O board is faulty.
		MC 68 defective.
E26	24 V for external output 2 is too low.	The 24 V voltage for the external output 2 (RS232) is too low.
		Fuse F2 on the I/O board has blown
E27	24 V for external output 3 is too low.	The 24 V voltage for the external output 3 (optional) is too low.
		Fuse F1 on the I/O board has blown
W28	Real time clock reset! Enter date and time!	Battery at MC68 is discharged or faulty.
		MC68 had been replaced.
E29	24 V supply for fans is too low (< 20 V).	Fuse F1 on wiring backplane has blown.
E30	24 V of the remote control is too low (< 20 V).	Fuse F1 on the I/O-board has blown.
W31	The offset voltage of the pre-amplifier is too high (> 5 mV).	The pre-amplifier is faulty.
W32	Pre-amplifier temperature is too high (> 65 °C).	Ambient temperature is too high.
		Air filter dirty.
W33	Pre-amplifier temperature is too low (< 2 °C).	Ambient temperature is too low.
		Temperature sensor is faulty.



**Table 23 Fault finding (continued)**

No.	Displayed message	Description and possible solutions
E34	24 V voltage at MSV board is too low!	Signal MVPZN on the MSV board is active. 24 V signal voltage is too low, $U < 18.3$ V.
		Fuse F1 on the MSV board has blown.
		Reference voltage UREF on the MSV board XT7/1 is too high, $U > 5$ V.
		DC/DC converter on the MSV board is defective.
		24 V power supply voltage of the main power supply is defective or stressed to much.
E35	Anode-cathode voltage is too high!	Anode-cathode voltage is $> 130$ V
		MSV board is faulty.
E36	Anode-cathode voltage is too low.	Anode-cathode voltage is $< 30$ V.
		MSV board is faulty.
		Fuse F4 on MSV board has blown.
E37	Suppressor voltage reference value too high!	Signal MFSZH on MSV board is active. Suppressor signal command variable is too high.
		Suppressor voltage has a short circuit.
		MSV is faulty.
E38	Suppressor potential too high!	Suppressor potential is higher than 363 V.
		MSV board is faulty.
E39	Suppressor potential is too low.	Suppressor potential is lower than 297 V.
		MSV board is faulty.
E40	The anode potential exceeds its nominal value by over 10%!	The actual anode potential exceeds its nominal value by 10%. The nominal value can be displayed in the service menu.
		MSV is faulty.
		MC 68 is faulty
E41	The anode potential has dropped below its nominal value by over 10%!	The actual anode potential has dropped below its nominal value by 10%. The nominal value can be displayed in the service menu.
		MSV is faulty.
		MC 68 is faulty.
E42	Nominal value of the anode potential is too high!	Signal MFAZH on MSV board is active.
		Anode voltage has been short circuited.
		Nominal value of the anode voltage is too high. Anode voltage is limited to about 1,200 V.

**Table 23 Fault finding (continued)**

No.	Displayed message	Description and possible solutions
E43	Cathode current is too high! MSV Cat-Heater >>	Signal MPKZH on MSV board is active. Cathode current is too high, $I > 3.6$ A.
		MSV is faulty.
E44	Cathode current is too low!	Signal MPKZN on MSV board is active. Cathode current is too low, $I < 0.2$ A.
		MSV is faulty.
		Faulty ion source connector or cable.
W45	Emission for cathode 1 can not be switched on!	Signal MSIBE on MSV board is not active. Emission for cathode 1 can not be switched on. ELD500 switches to cathode 2. Order a new ion source.
		Cathode 1 is defective
		MSV board is defective
W46	This page has been inserted into the manual. Emission for cathode 2 can not be switched.	Signal MSIBE on MSV board is not active. Emission for cathode 2 can not be switched on. ELD500 switches to cathode 1. Order a new ion source.
		Cathode 2 is defective.
		MSV board is defective.
E47	Emission for both cathodes can not be switched on!	Signal MSIBE on MSV board is not active. Emission can not be switched on. Exchange the cathode by changing the ion source. After having exchanged the ion source it must be possible to switch on both cathodes manually via the service menu.
		Replace ion source.
		MSV board is defective.
E48	Anode heater is faulty!	Signal MSAFD on MSV board is active. Anode heater fuse has blown.
		Replace fuse F2 on the MSV board.
E50	No communication with turbo pump converter.	Clock from the frequency converter has failed. No communication to the frequency converter.
		Fuse F4 on the wiring backplane has blown.
		Drive electronics Turbo Drive S is defective.
E51	Unknown TMP error	The frequency converter Turbo Drive S indicates an unknown error code. Inform Edwards service
E52	TMP frequency is too low!	TMP frequency is too low!
		Frequency converter is faulty.
		Turbo molecular pump is faulty.

**Table 23** Fault finding (continued)

No.	Displayed message	Description and possible solutions
W53	Temperature at electronic unit is too high (> 59 °C)	Ambient temperature too high.
		Ventilation failure.
		Air filter dirty and have to be changed.
E54	Temperature at electronic unit is too high (> 60 °C).	Ambient temperature is too high.
		Internal ventilation has failed.
		Air filters are dirty and must be exchanged.
W55	Temperature at electronic unit is too low (< 2 °C)	The temperature sensor on the wiring plane indicates $T < 2$ °C. Run-up time for the fore vacuum pump will be longer.
		Temperature sensor is faulty.
		Ambient temperature is too low.
E56	Inlet pressure p1 too low!	Output voltage Pirani P1 $U < 0.27$ V.
		Pirani sensor P1 is defective.
		Pirani electronics on the I/O board is defective.
E58	fore vacuum pressure p2 too low!	Output voltage Pirani P2 $U < 0.27$ V.
		Pirani sensor P2 is defective.
		Pirani electronics on the I/O board is defective.
E60	p2 > 10 mbar after 5 minutes since power on	Run-up time of the fore vacuum pump is too long.
		Fore pump is faulty.
		Valve V2 does not open.
		Leak in the high vacuum system.
E61	Emission fail.	Emission could not be switched on. MSV sub-assembly indicates a fault. MENB emission current not within range.
		MSV board is defective.
		Both cathodes are defective, replace ion source.
W62	Flow through capillary to low.	In the sniffer mode the intake pressure of the sniffer line is controlled. If the pressure falls below the minimum limit, the flow through the capillary is too low (contamination) or the capillary is blocked (foreign objects, particles).
		The minimum limit can be set by the menu. Default value is 0.05 mbar.
		Filter in the tip is clogged.

Table 23 Fault finding (continued)

No.	Displayed message	Description and possible solutions
W63	Capillary broken	In the sniffer mode the intake pressure of the sniffer line is controlled. If the pressure exceeds the maximum limit, the flow through the capillary is too high (no leak tightness, broken capillary).
		The maximum limit can be set by the menu. Default value is 0.15 mbar.
		The capillary is broken or has been torn off.
E64	TMP error: Nominal speed has been exceeded by over 10%	Nominal speed of the pump has been exceeded by over 10%
		EMC problems: Check connecting cable, insert it properly. Switch the power supply voltage off and then on again.
		Turbo.Drive S faulty: Inform Edwards Service
E65	TMP error: Pass through time exceeded This page has been intentionally left blank.	Maximum time for passing through the critical frequencies has been exceeded.
		Fore vacuum or high-vacuum pressure to high: Reduce the inlet pressure of the ELD500
		Bearing defective: Inform Edwards service for repair
E66	TMP error: Bearing temperature too high (> 67 °C)	Maximum bearing temperature has been exceeded
		Fore vacuum or high-vacuum pressure to high: Reduce the inlet pressure of the ELD500
		Fan defective: Replace the fan
		Ambient temperature too high: Feed cooler air to the ELD500
		Bearing defective: Inform Edwards service for repair
E67	TMP error: Short circuit in TMP-motor or connecting cable	Short circuit in the pump's motor or the connecting cable
		Check to see if the connecting cable is undamaged, exchange if required.
		Inform Edwards service in case of short circuit in TMP motor
E68	TMP error: temperature converter too high (> 75 °C)	Maximum temperature for the converter has been exceeded.
		Ambient temperature too high: Feed cooler air to the ELD500
		Fan defective: Replace the fan
		Fore vacuum or high-vacuum pressure to high: reduce the inlet pressure of the ELD500

**Table 23** Fault finding (continued)

No.	Displayed message	Description and possible solutions
E69	TMP error: Run-up time out	Maximum time after which the pump must enter its normal operation mode has been exceeded.
		Fore vacuum or high-vacuum pressure to high: Reduce the inlet pressure of the ELD500
		Bearing defective: Inform Edwards service for repair
E70	TMP error: TMP motor temperature too high (> 90 °C)	Max. motor temperature has been exceeded.
		Fore vacuum or high-vacuum pressure to high: Reduce the inlet pressure of the ELD500
		Fan defective: Replace the fan
		Ambient temperature too high: Feed cooler air to the ELD500.
		Bearing defective: Inform Edwards service for repair
E71	TMP error: TMP could not be identified	Pump could not be identified or no pump is connected.
		Pump not connected to Turbo.Drive S: Check connecting cable
E72	Emission off (P1 too high)	Air inrush
E73	Emission off (p2 too high)	The emission is switched off as soon as the pressure P2 > 0.2 mbar or 1.5 mbar in the measurement mode. If after closing the inlet valve the pressure drops again, the leak detector will revert to the standby mode.
		Air inrush in the measurement mode.
W74	Error proportional valve or control electronics (ELD500 DRY only)	Proportional valve V4b or control electronics for proportional valve V4b mounted on top-hat rail next to fore-pump non-existent or faulty.
W75	Maximum evacuation time exceeded. Within the pre-set evacuation time the pressure of 100 mbar was not reached.	"Test sample has got a GROSS leak." and "Wrong setting (too short) of maximum time of evacuation."
W76	Maximum evacuation time until measurement exceeded. Within the pre set evacuation time measurement mode was not reached.	"Test sample has got a GROSS leak." and "Wrong setting (too short) of maximum time of evacuation."

Table 23 Fault finding (continued)

No.	Displayed message	Description and possible solutions
W77	Peak not in range	The signal maximum has shifted to mass range alignment limits.
		Signal of leak rate was unstable during mass adjustment. Calibrate again.
		Check the basic setting for the anode voltage through the service menu.
		Check calibrated leak.
W78	Differences of signal between test leak open and closed is too low.	The amplifier voltage difference between opened and closed calibrated leak is less than 10 mV.
		Calibrated leak has not been closed properly.
W79	Signal of test leak is too small	Calibrated leak is too small or has not been opened. Pre-amplifier voltage < 10 mV.
W80	Calibrate machine newly	The automatic request of calibration is activated and has fulfilled at least one of the conditions:
		30 minutes are passed since power on.
		Temperature of the pre-amplifier has changed more than 5 °C since the last calibration.
		Mass adjustments were changed.
		Change of TMP speed to 920 Hz, GROSS only mode
W81	CAL Factor too low	The calculated factor falls out of the valid range (< 0.1). The old factor is retained.
		Possible fault cause:
		The conditions for calibration have not been maintained.
		The leak rate of the internal calibrated leak which was entered is much too small.
		The internal test leak is defect.
W82	CAL Factor too high	The calculated factor is out of the valid range (> 10). The old factor is retained.
		Possible fault cause:
		The conditions for calibration have not been maintained.
		The leak rate of the internal calibrated leak which was entered is much too high or much too small.
W83	All EEPROM parameter lost. Check the settings.	EEPROM on back plane is empty and was initialized with default valves. Enter all parameters again.
		The EEPROM might be faulty when warning comes up again after power up.

**Table 23** Fault finding (continued)

No.	Displayed message	Description and possible solutions
W84	EEPROM parameter initialized. Check the settings	Software update has been installed
W85	Lost EEPROM parameter! Check the settings!	Writing access was interrupted. Check all adjustments.
		An software update was done. In this case the notice can be ignored.
		When warning comes up again after powering up the EEPROM might be faulty.





## Waste disposal

The equipment may have been contaminated by the process or by environmental influences. In this case the equipment must be decontaminated in accordance with the relevant regulations. We offer this service at fixed prices.

Further details are available on request.

Contaminated parts can be detrimental to health and environment. Before beginning any work, first find out whether any parts are contaminated. Adhere to the relevant regulations and take the necessary precautions when handling contaminated parts.

Separate clean components according to their materials, and dispose of these accordingly. We offer this service. Further details are available on request.

When sending us any equipment, observe the regulations given in [Service](#).



This page has been intentionally left blank.

This page has been intentionally left blank.

## Return of Edwards Equipment - Procedure

### INTRODUCTION

Before returning your equipment, you must warn Edwards if substances you used (and produced) in the equipment can be hazardous. This information is fundamental to the safety of our Service Centre employees and will determine the procedures employed to service your equipment.

Complete the Declaration (HS2) and send it to Edwards before you dispatch the equipment. It is important to note that this declaration is for Edwards internal use only, and has no relationship to local, national or international transportation safety or environmental requirements. As the person offering the equipment for shipment, it is your responsibility to ensure compliance with applicable laws.

### GUIDELINES

- Equipment is 'uncontaminated' if it has not been used, or if it has only been used with substances that are not hazardous. Your equipment is 'contaminated' if it has been used with any substances classified as hazardous under the UN Globally Harmonised System on the classification and labelling of chemicals (GHS), EU Regulation No 1272/2008 on classification, labelling and packaging (CLP) or US Occupational Safety and Health regulations (29CFR1910.1200, Hazard Communication).
- If your equipment has been used with radioactive substances, biological or infectious agents, mercury, polychlorinated biphenyls (PCB's), dioxins or sodium azide, you must decontaminate it before you return it to Edwards. You must send independent proof of decontamination (for example a certificate of analysis) to Edwards with the Declaration (HS2). Phone Edwards for advice.
- If your equipment is contaminated, you must either:
  - Remove all traces of contamination (to the satisfaction of laws governing the transportation of dangerous/hazardous substances).
  - Or, properly classify the hazard, mark, manifest and ship the equipment in accordance with applicable laws governing the shipment of hazardous materials.

**Note: Some contaminated equipment may not be suitable for airfreight.**

### PROCEDURE

1. Contact Edwards and obtain a Return Authorisation Number\* for your equipment.
2. Complete the Return of Edwards Equipment - Declaration (HS2).
3. If the equipment is contaminated, you must contact your transporter to ensure that you properly classify the hazard, mark, manifest and ship the equipment, in accordance with applicable laws governing the shipment of contaminated/hazardous materials. As the person offering the equipment for shipment, it is your responsibility to ensure compliance with applicable law. **Note: Equipment contaminated with some hazardous materials, such as semiconductor by-products, may not be suitable for airfreight - contact your transporter for advice.**
4. Remove all traces of hazardous gases: pass an inert gas through the equipment and any accessories that will be returned to Edwards. Where possible, drain all fluids and lubricants from the equipment and its accessories.
5. Seal up all of the equipment's inlets and outlets (including those where accessories were attached) with blanking flanges or, for uncontaminated product, with heavy gauge tape.
6. Seal equipment in a thick polythene/polyethylene bag or sheet.
7. If the equipment is large, strap the equipment and its accessories to a wooden pallet. If the equipment is too small to be strapped to a pallet, pack it in a suitable strong box.
8. E-mail via scan, fax or post a copy of the original with signature of the Declaration (HS2) to Edwards. The Declaration must arrive before the equipment.
9. Give a copy of the Declaration (HS2) to the transporter. You must tell your transporter if the equipment is contaminated.
10. Seal the original Declaration in a suitable envelope: attach the envelope securely to the outside of the equipment package, in a clear weatherproof bag.

**WRITE YOUR RETURN AUTHORISATION NUMBER\* CLEARLY ON THE OUTSIDE OF THE ENVELOPE OR ON THE OUTSIDE OF THE EQUIPMENT PACKAGE.**

\* not applicable in Japan

# Return of Edwards Equipment - Declaration

Return Authorisation Number: \_\_\_\_\_

You must:

- Know about all of the substances which have been used and produced in the equipment before you complete this Declaration
- Read the Return of Edwards Equipment - Procedure (HS1) before you complete this Declaration
- Contact Edwards to obtain a Return Authorisation Number and to obtain advice if you have any questions
- Send this form to Edwards before you return your equipment as per the procedure in HS1

## SECTION 1: EQUIPMENT

Manufacturer's Product Name \_\_\_\_\_  
 Manufacturer's Part Number \_\_\_\_\_  
 Manufacturer's Serial Number \_\_\_\_\_

Has the equipment been used, tested or operated?  
 YES, Used or operated  Go to Section 2  
 YES, Tested, but not connected to any process or production equipment, and only exposed to Nitrogen, Helium or Air  Go to Section 4  
 NO  Go to Section 4

**IF APPLICABLE:**

Tool Identification Number \_\_\_\_\_  
 Tool Manufacturer/OEM \_\_\_\_\_  
 Tool Model \_\_\_\_\_  
 Process \_\_\_\_\_  
 Installed Date \_\_\_\_\_ De-installed Date \_\_\_\_\_  
 Part Number of Replacement Equipment \_\_\_\_\_  
 Serial Number of Replacement Equipment \_\_\_\_\_  
 Pump datalog attached? YES  NO   
 (Edwards Internal Use Only)

## SECTION 2: SUBSTANCES IN CONTACT WITH THE EQUIPMENT

Are any substances used or produced in the equipment:

- Radioactive, biological or infectious agents, mercury, poly chlorinated biphenyls (PCBs), dioxins or sodium azide? (if YES, see Note 1) YES  NO
- Hazardous to human health and safety? YES  NO

**Note 1:** Edwards will not accept delivery of any equipment that is contaminated with radioactive substances, biological/infectious agents, mercury, PCB's, dioxins or sodium azide, unless you:

- Decontaminate the equipment
- Provide proof of decontamination

**YOU MUST CONTACT EDWARDS FOR ADVICE BEFORE YOU RETURN SUCH EQUIPMENT**

## SECTION 3: LIST OF SUBSTANCES IN CONTACT WITH THE EQUIPMENT

Substance name	Chemical Symbol	Precautions required (for example, use protective gloves, etc.)	Action required after a spill, leak or exposure

## SECTION 4: RETURN INFORMATION

Reason for return and symptoms of malfunction: \_\_\_\_\_

For how many hours has the product run? \_\_\_\_\_ Do you wish to purchase a full Failure Analysis report? YES  NO

If you have a warranty claim:

- who did you buy the equipment from? \_\_\_\_\_
- give the supplier's invoice number \_\_\_\_\_

## SECTION 5: DECLARATION

Print your name: \_\_\_\_\_ Print your job title: \_\_\_\_\_  
 Print your organisation: \_\_\_\_\_  
 Print your address: \_\_\_\_\_

Telephone number: \_\_\_\_\_ Date of equipment delivery: \_\_\_\_\_

I have made reasonable enquiry and I have supplied accurate information in this Declaration. I have not withheld any information, and I have followed the Return of Edwards Equipment - Procedure (HS1).

Signed: \_\_\_\_\_ Date: \_\_\_\_\_

**Note: Please print out this form, sign it and return the signed form as hard copy.**

This page has been intentionally left blank.

